

# Local Horizon and Sundials

Rosa M. Ros

*International Astronomical Union  
Technical University of Catalonia, Spain*



# Goals

- Understand the diurnal movement of the Sun
- Understand the annual movement of the Sun
- Understand the movement of the celestial sphere
- Understand the construction of sundials



# The Earth rotates and moves

rotation (day / night)

orbital position (seasons)

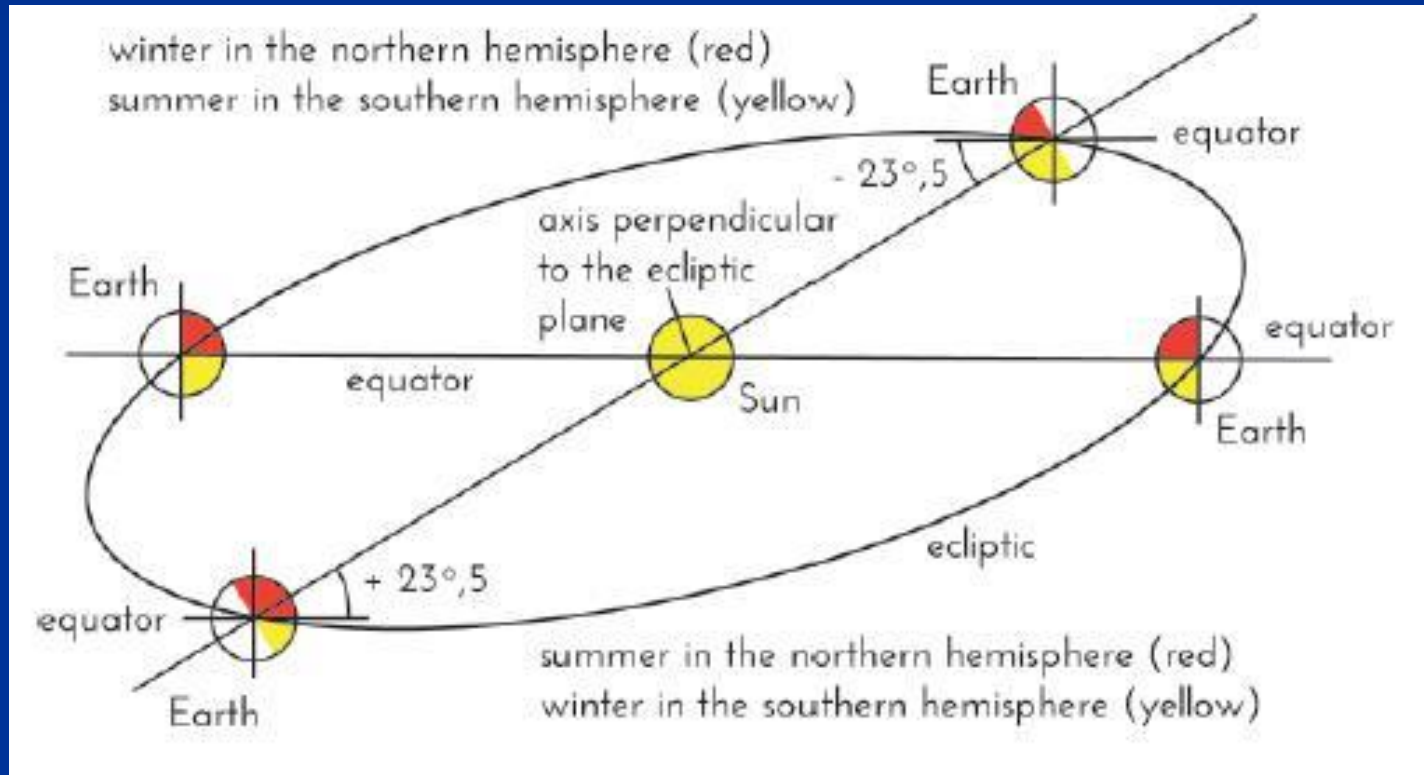

# Activity 1: Four Earth spheres with the Sun (a lamp) in the middle.

The line from the centre of the Sun to the centre of the Earth makes a  $23.5^\circ$  angle with the ground (which represents the plane of the Equator).





Winter in the  
Northern  
Hemisphere

Summer in the  
Southern  
Hemisphere



Summer in the  
Northern  
Hemisphere

Winter in the  
Southern  
Hemisphere



# Activity 2: Parallel Earth

A spotlight illuminates two spheres in the same way and produces the same areas of light and shadow



## Activity 2: Parallel Earth



- \* Remove the globe from its mounting, take it outside and stand it on a glass
- \* Carefully orientate its rotational axis with a compass
- \* Turn it so our location is at the top

# Activity 2: Parallel Earth

Place:

- \* a doll indicating our position
- \* pieces of clay to mark the light / shadow line (it advances with time)
- \* pieces of toothpick to create shadows to study





# Activity 2: Parallel Earth

\* The North Pole is on the sunny side so it is summer in the Northern Hemisphere (the midnight sun)

\* The South Pole is in shadow and therefore in the Southern Hemisphere it is winter





## Activity 2: Parallel Earth

\* The North Pole is within the area at darkness, so it is in the Northern hemisphere's winter.

\* South Pole is illuminated and so it is summer in the Southern hemisphere.



# Activity 2: Parallel Earth

When the day / night shadow line passes through both poles, it is the first day of spring or the first day of autumn.



# Activity 2: Parallel Earth

North H. summer

North H. equinoxes

North H. winter



South H. winter

South H. equinoxes

South H. summer



# Rotation and celestial movements of day and night

- Not the same when seen from inside and outside

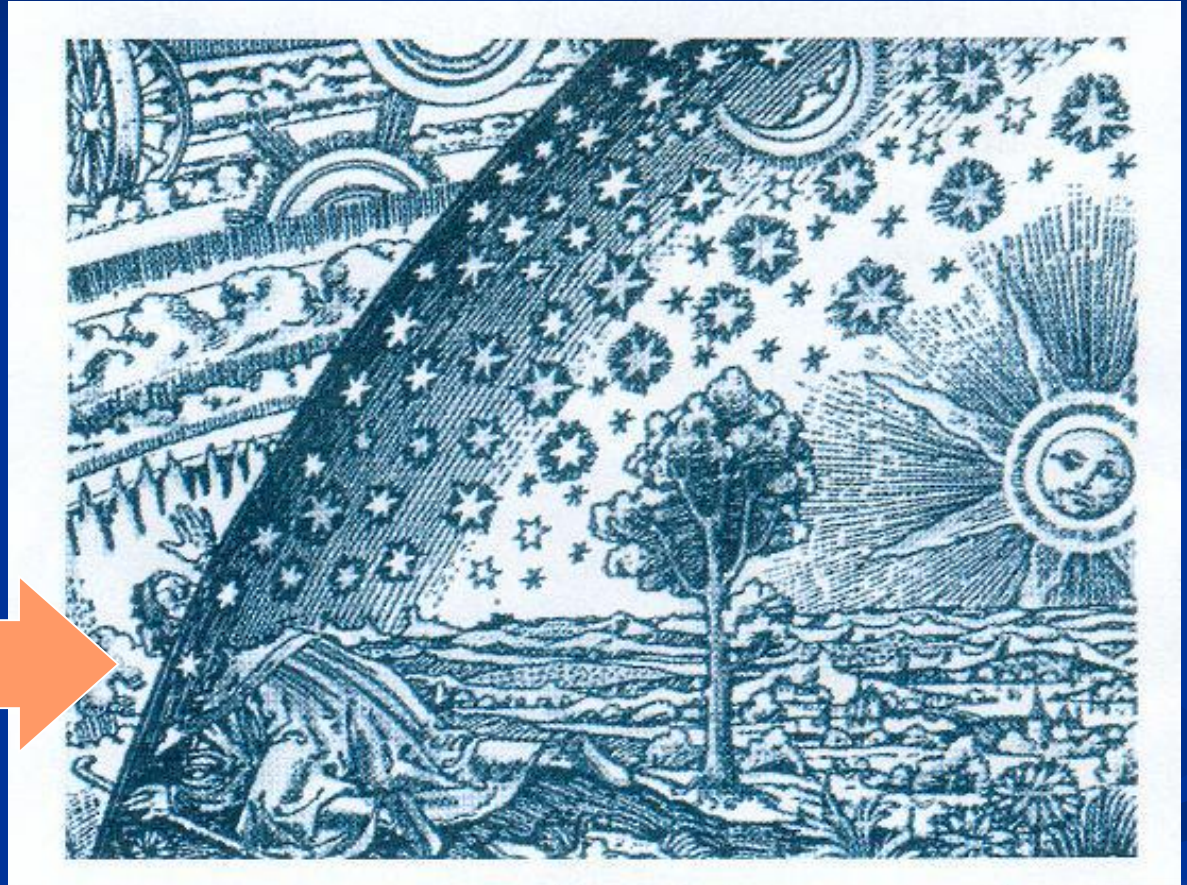

# Celestial sphere "from outside"

SUN DAY MOVEMENT

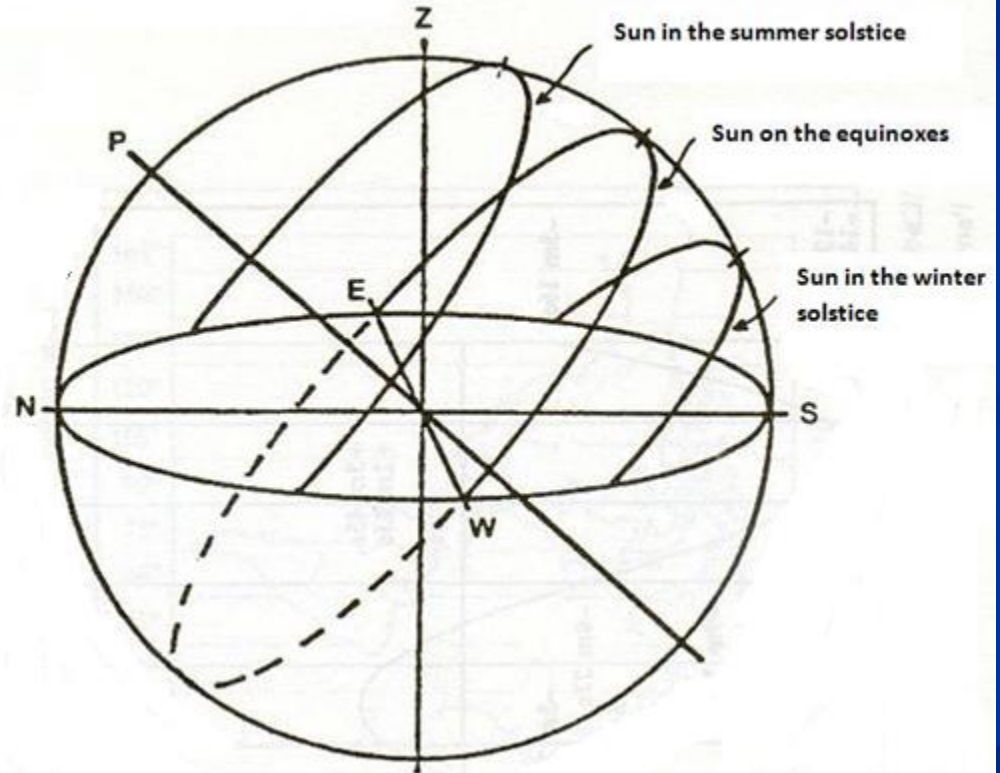
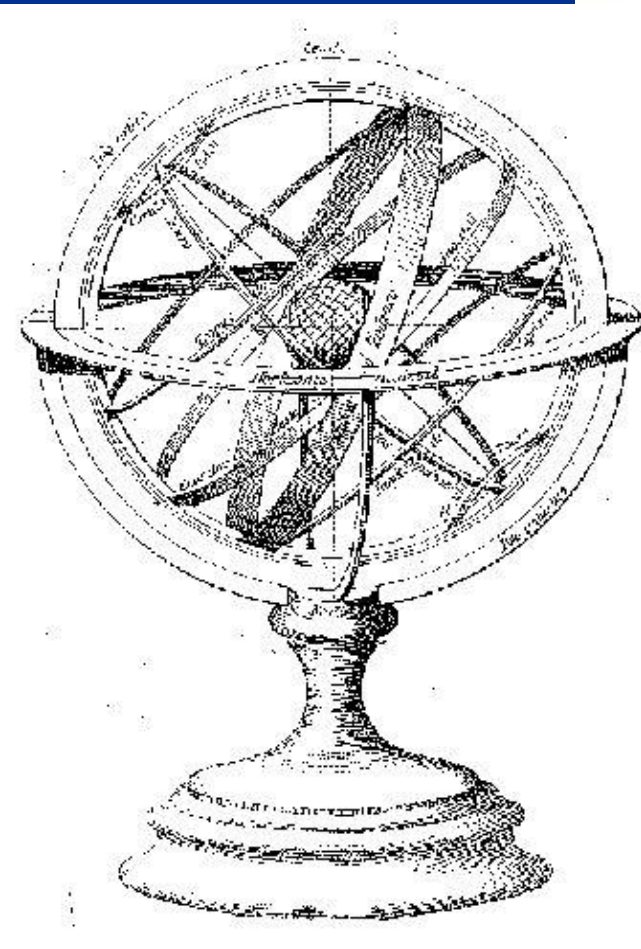



... it seems that everything is understood

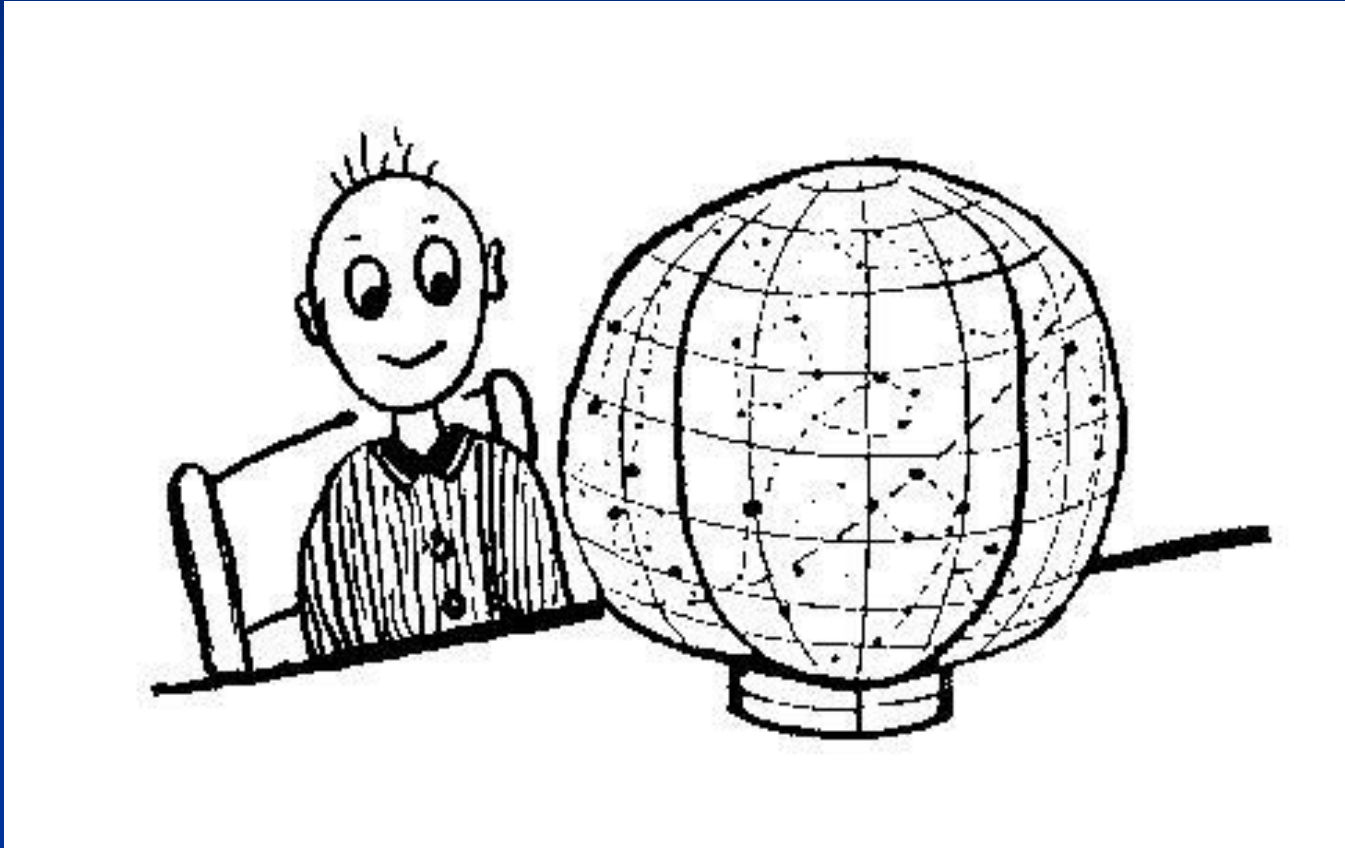

... but after class, ... he is disconcerted

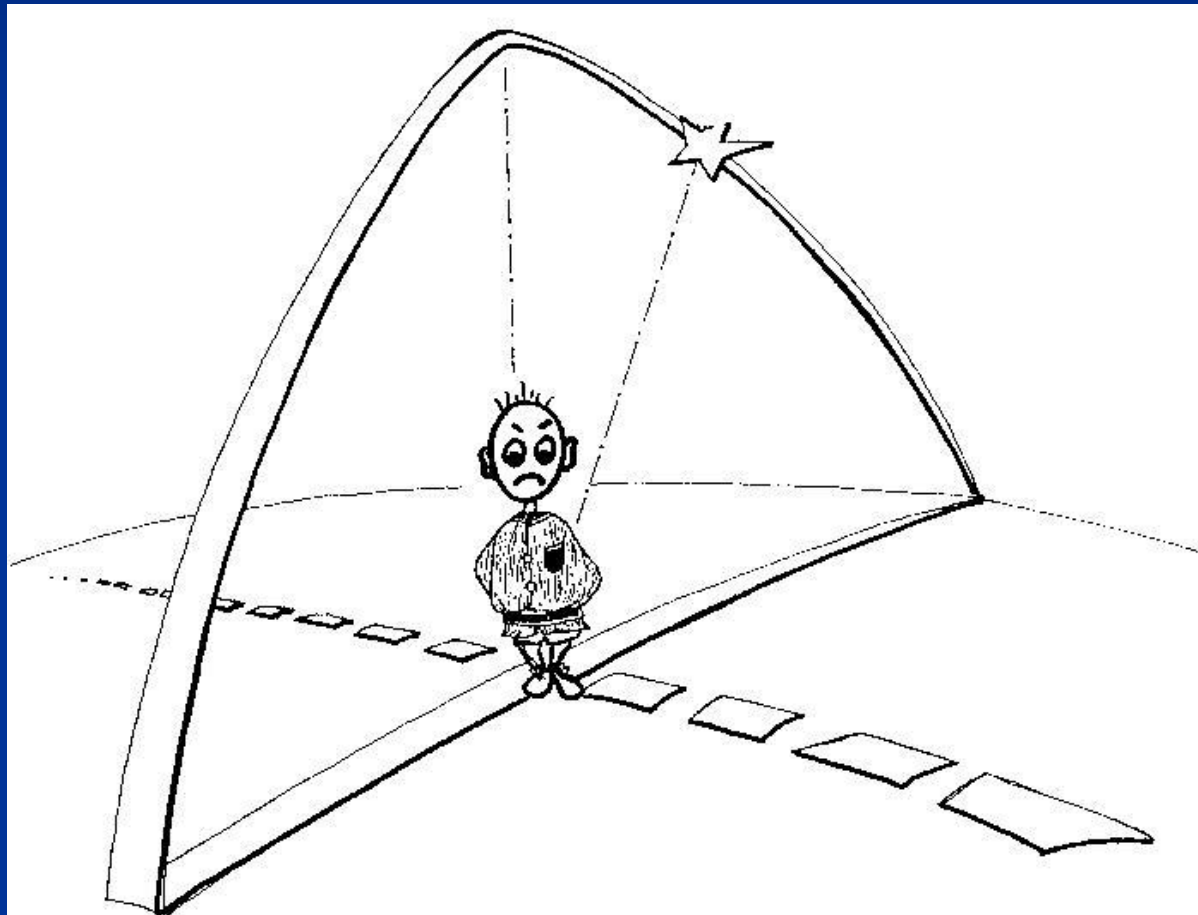

# All schools have an "Astronomy Laboratory"

- They have a playground or school yard
- They have the sky above
- They have clear days and nights
- **THESE MUST BE USED!**



**Activity 3: We will build a  
model of the horizon  
visible from school**



# Begin by photographing all round your location

## ■ local horizon



Figure 1: Zona del horizonte fotografiada en Barcelona.

1 Catedral, 2 Montjuic, 3 Tibidabo,  
4 Sagrada Familia, 1 Catedral.





Let's glue the photos together on a supporting platform

■ local horizon

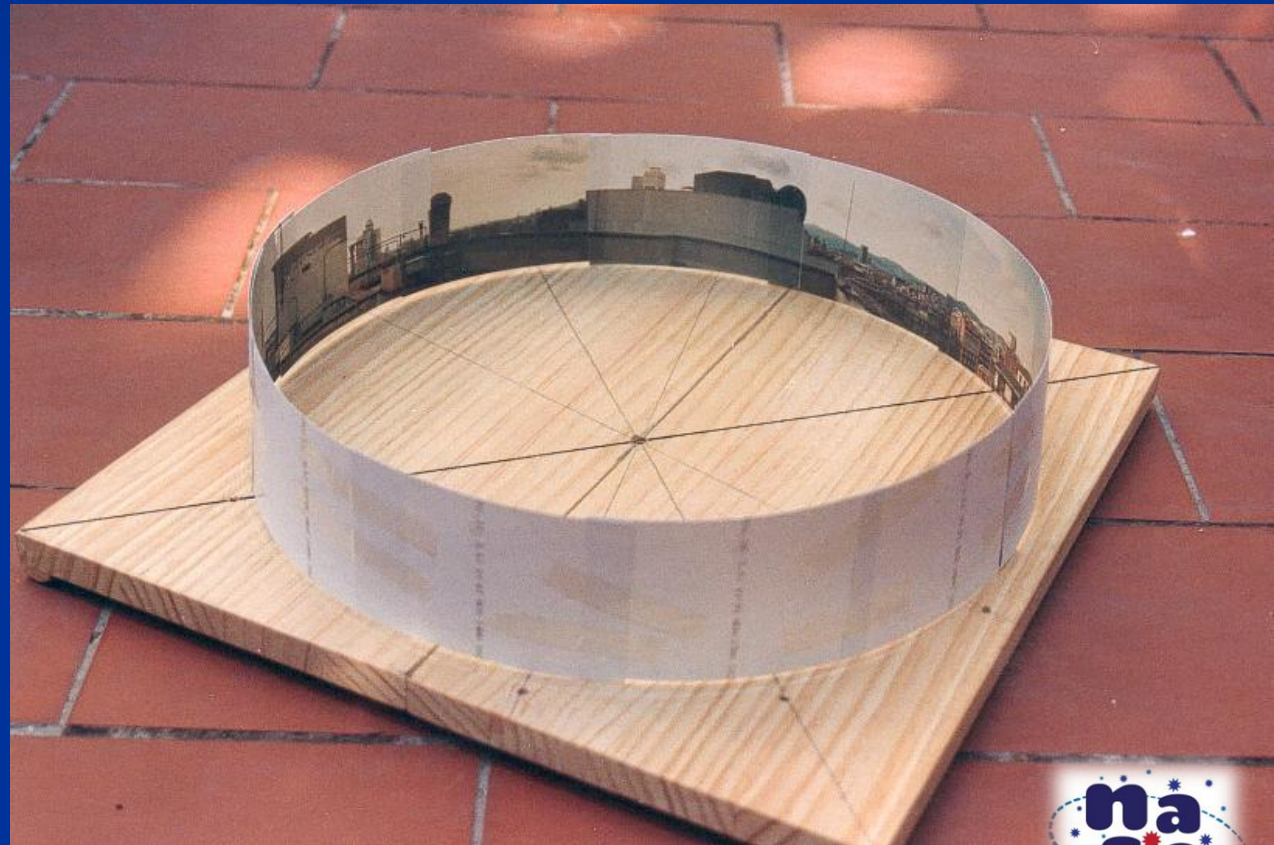

... we must adjust the photographed horizon to align it with the real horizon

- The N - S line and local meridian

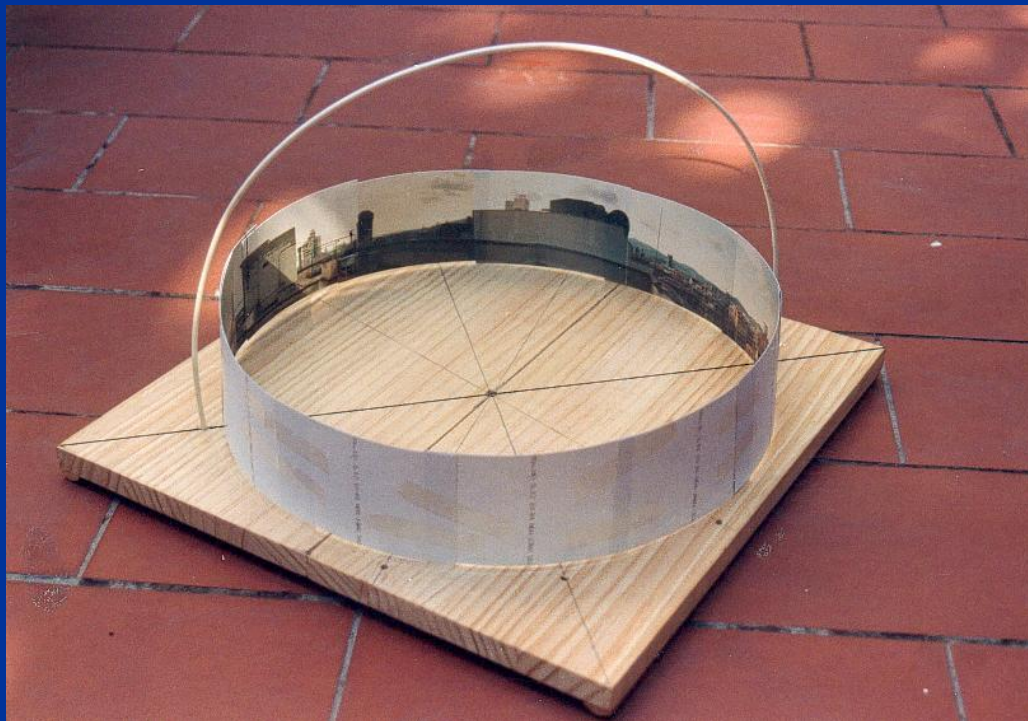

To position the model we can use the compass direction, or better, we can use the projection of the pole above the horizon





# Introducing the Earth's rotation

- axis of the Earth

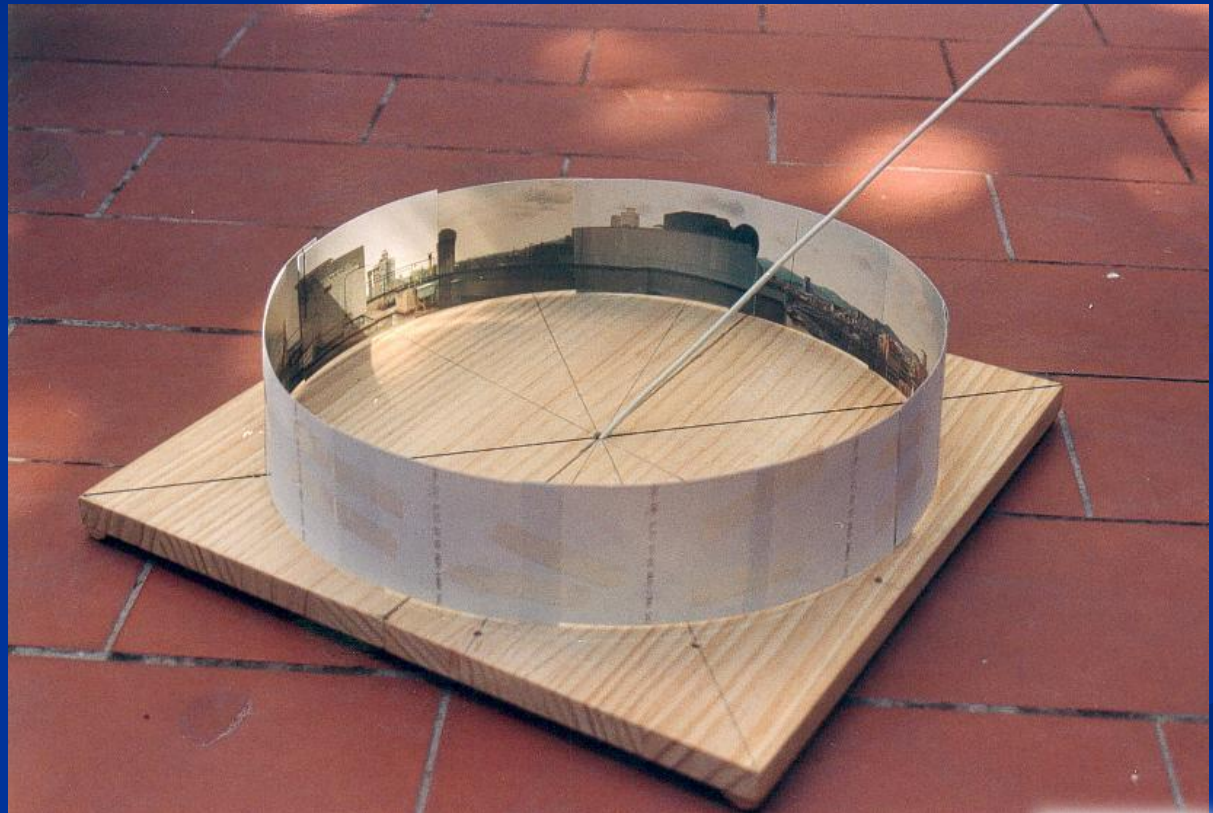

The altitude of  
the pole is  
equal to your  
latitude

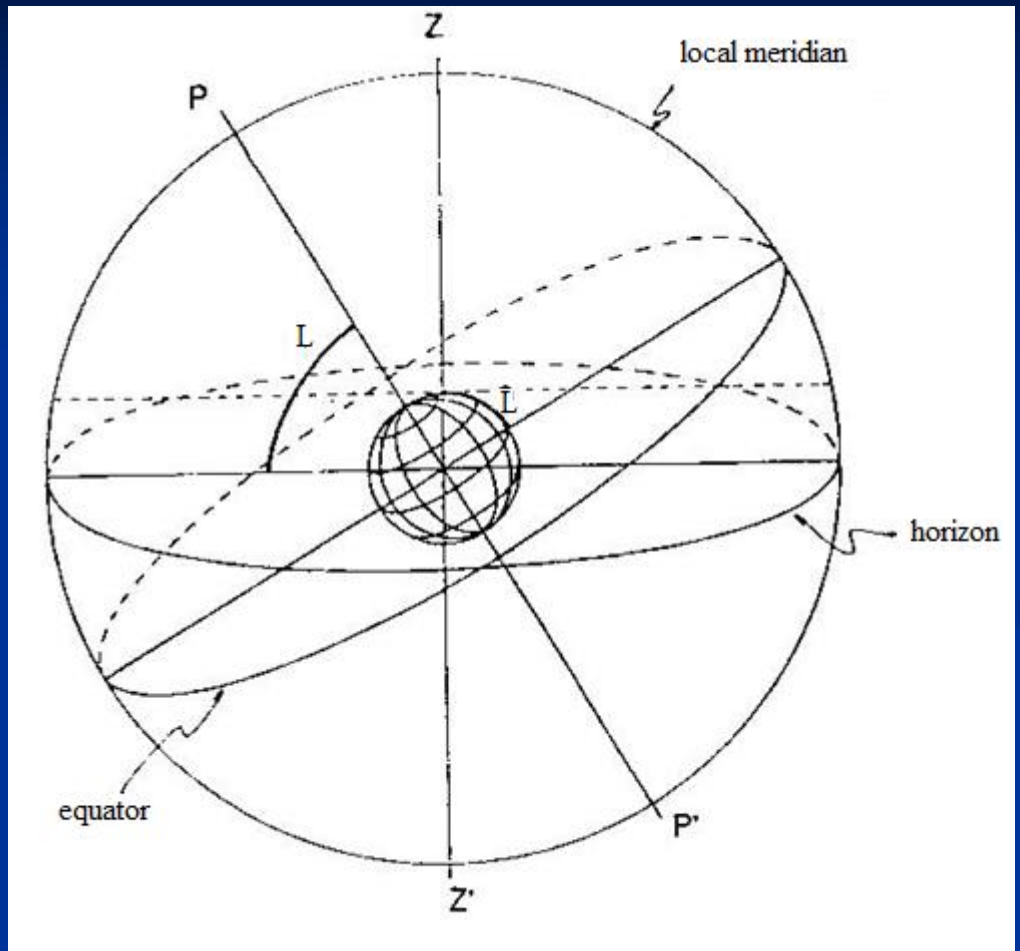



# Indicate the apparent path of the sun on the first day of spring or autumn

- Use the Sunrise or Sunset photos



# Movement due to Earth's rotation: Note the angle of the Sun's path

- Day - several images near sunset





# Movement due to Earth's rotation: Note the angle of the star trails

- Night – a time exposure of the stars



# Rotational movement in the model

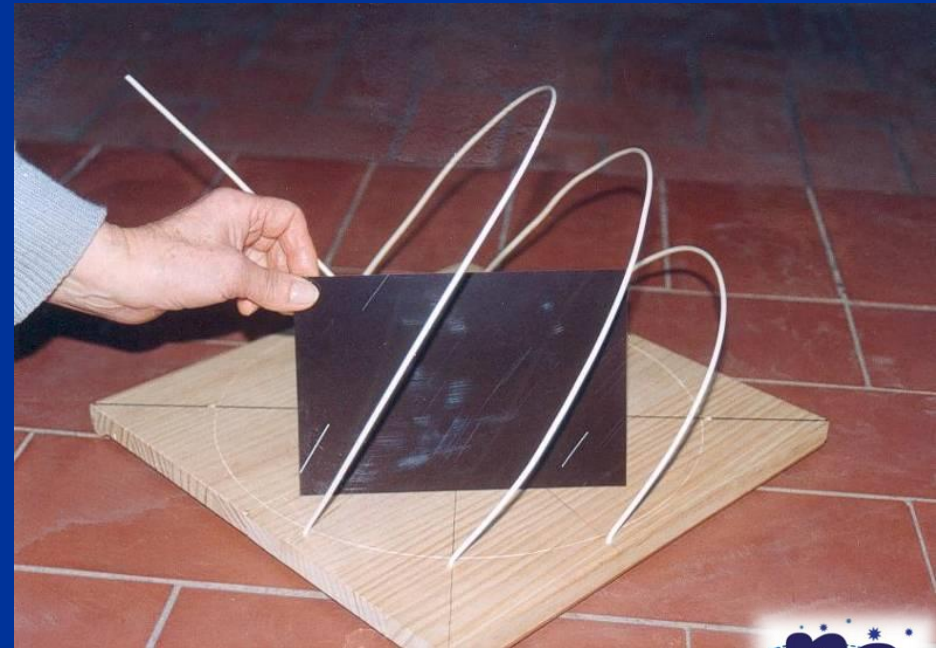
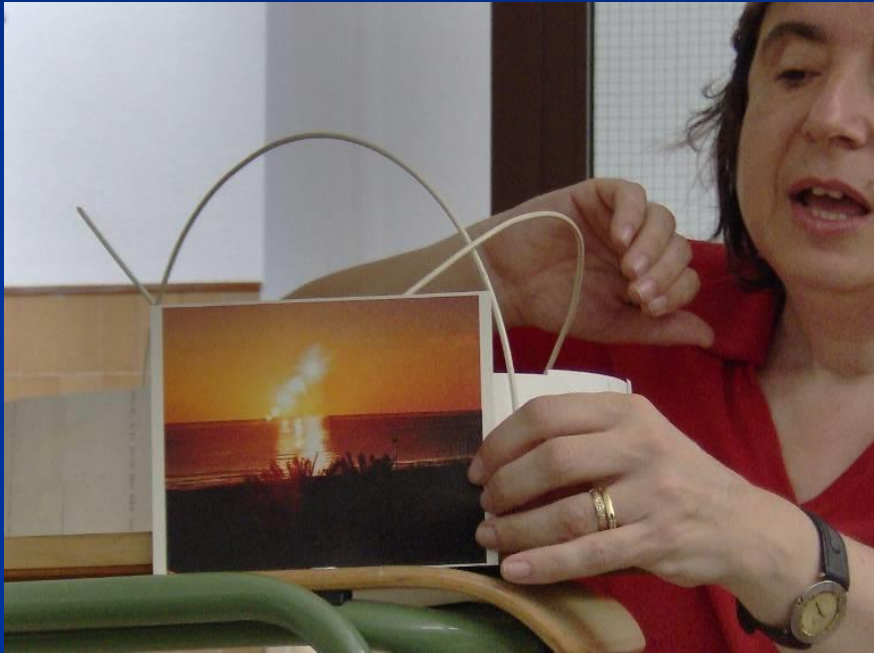

# The inclination of the Sun's apparent path and of the star trails depend on latitude

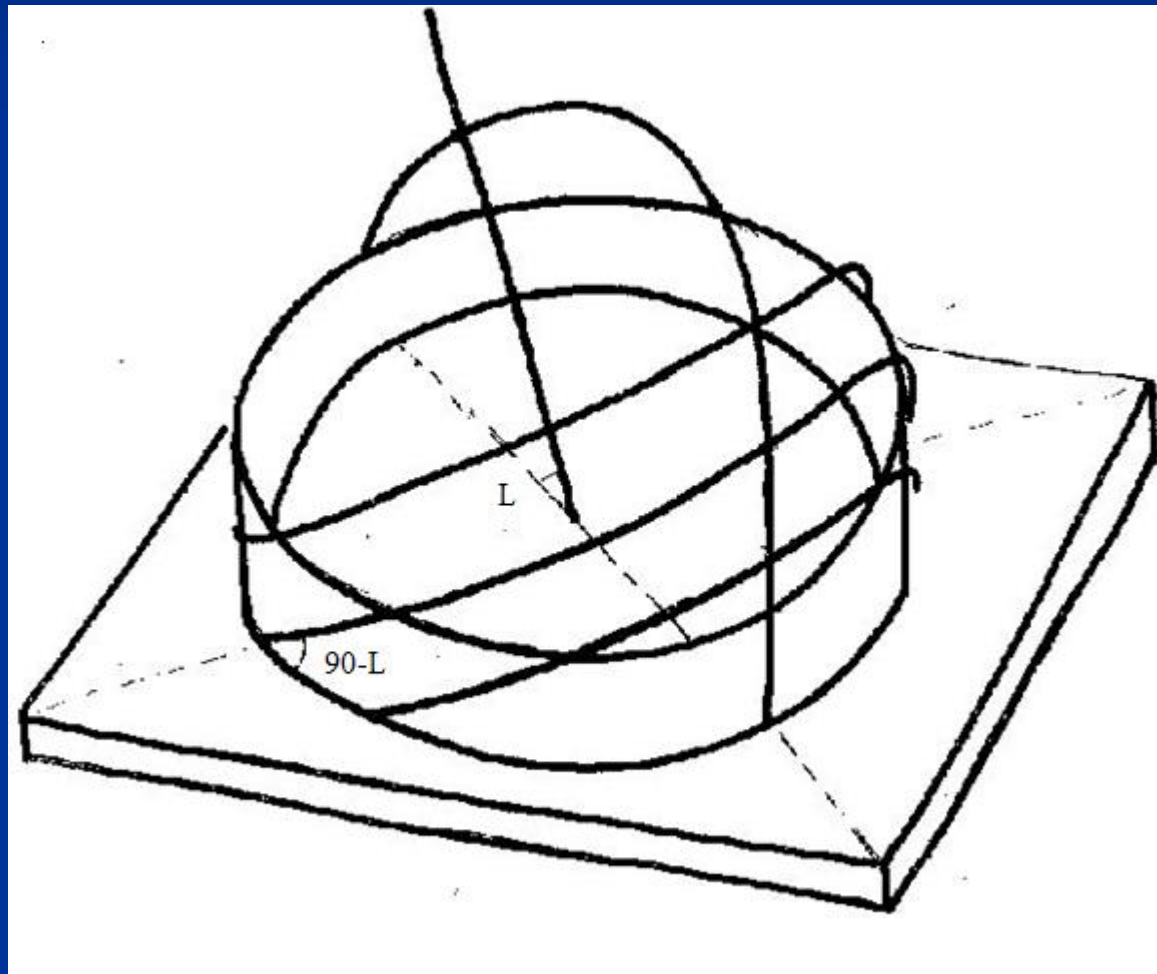



# Solar paths on first day of each season (note the different durations)

- Summer Solstice
- Autumnal / Vernal Equinox
- Winter Solstice

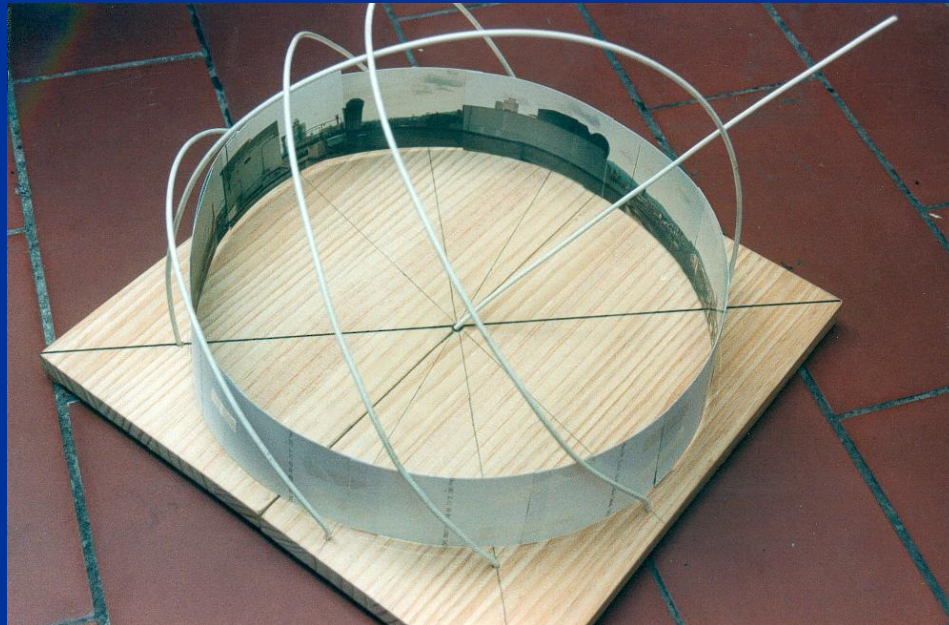



# Orbital motion leads to the seasonal positions

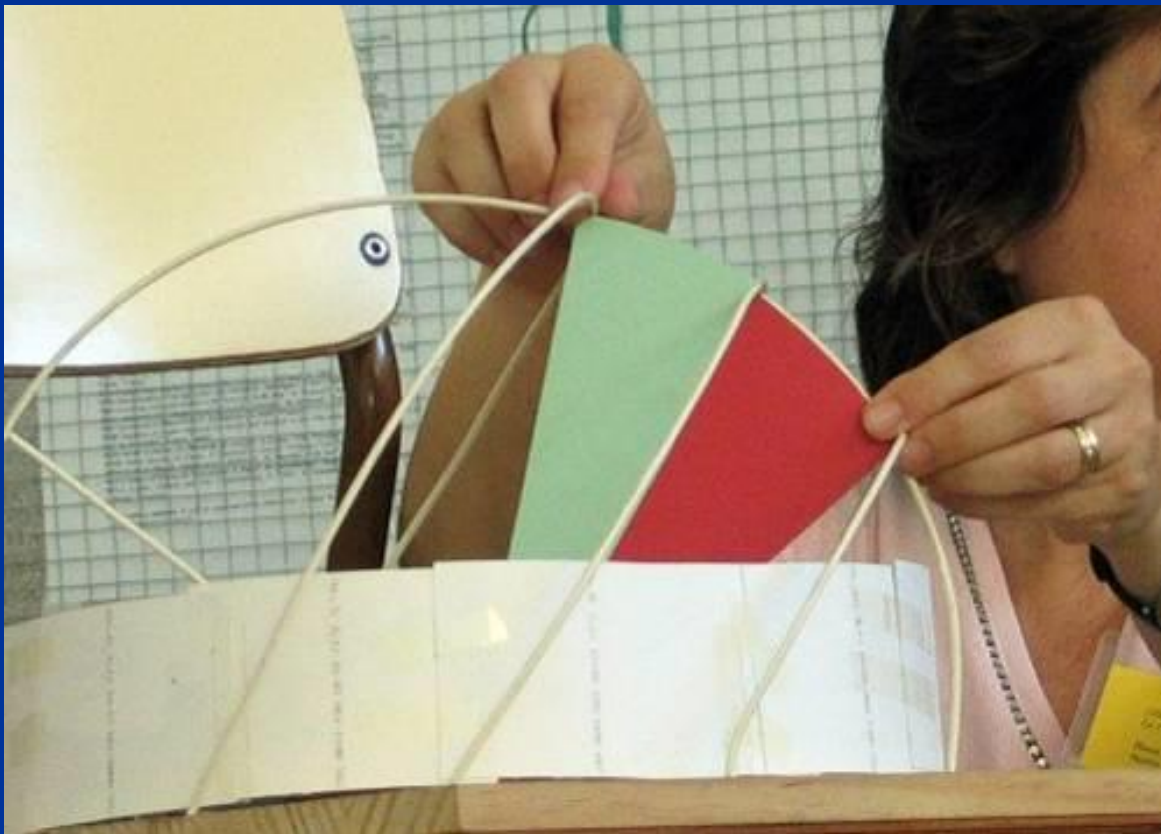

- Summer
- Spring / Autumn
- Winter
- Angle between equator and Tropic of Cancer or Tropic of Capricorn =  $23.5^\circ$



# The Earth's orbital motion leads to the change of the position of sunsets every day

■ 3 sunsets:

Winter – Spring or Autumn – Summer



# Viewing the "meridian" in the model

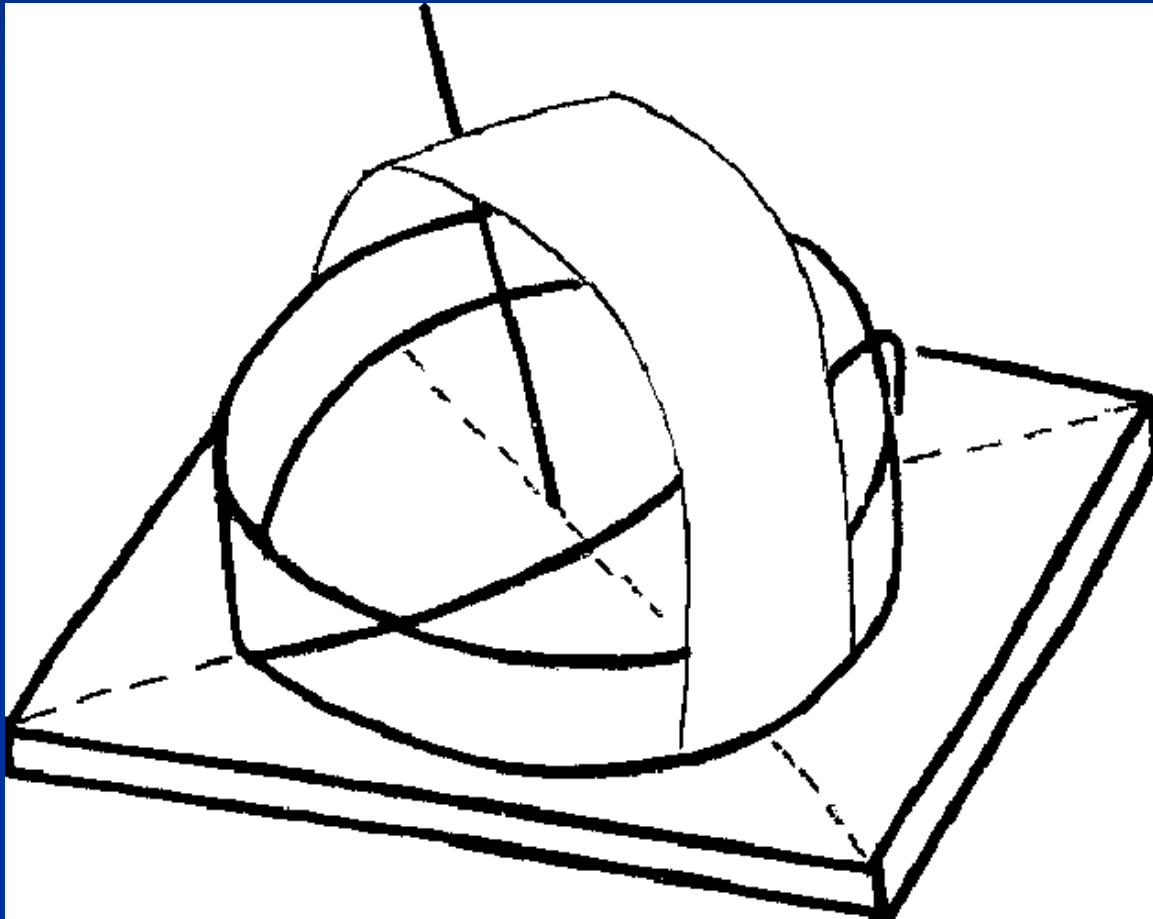



...around the pole - circles





...near the equator the paths change from  
concave to convex



...the model is no more than an  
**Equatorial Sundial!**

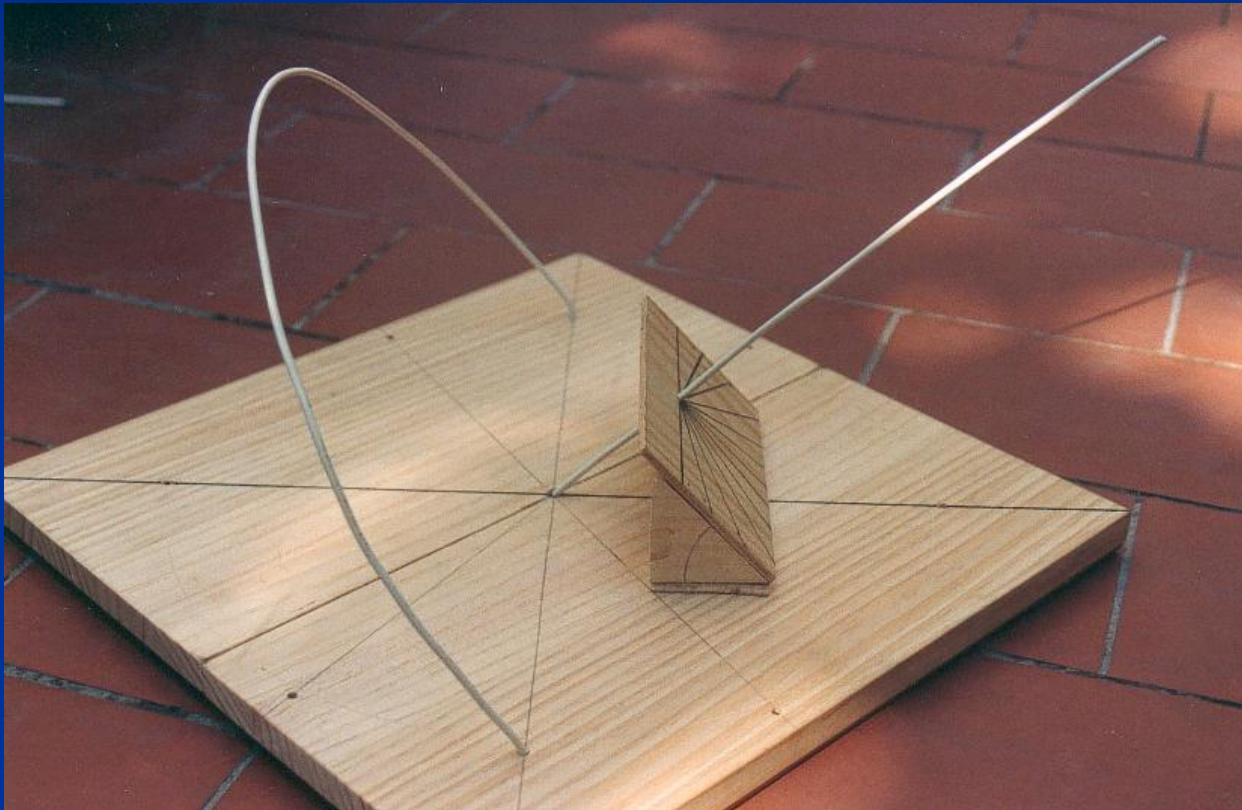



...other sundials can be made from the equatorial one

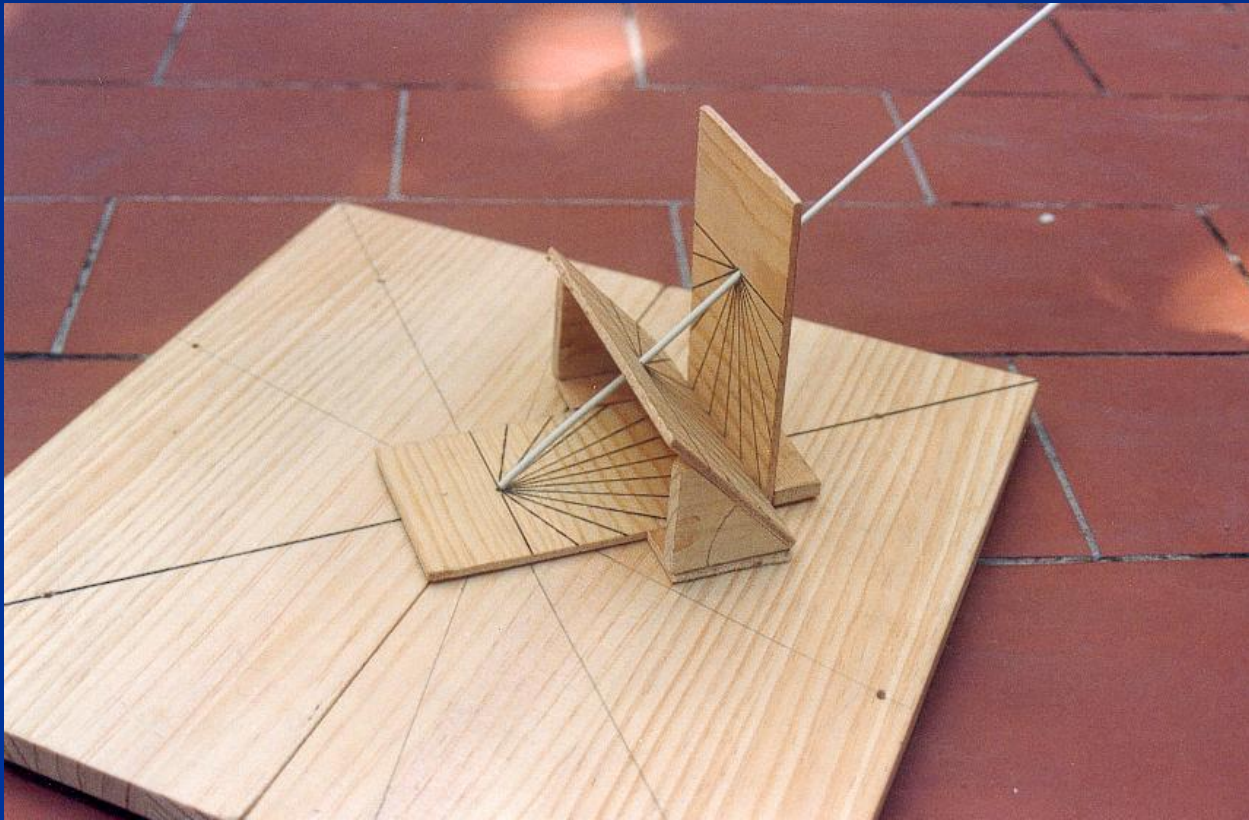

# ... the horizontal sundial

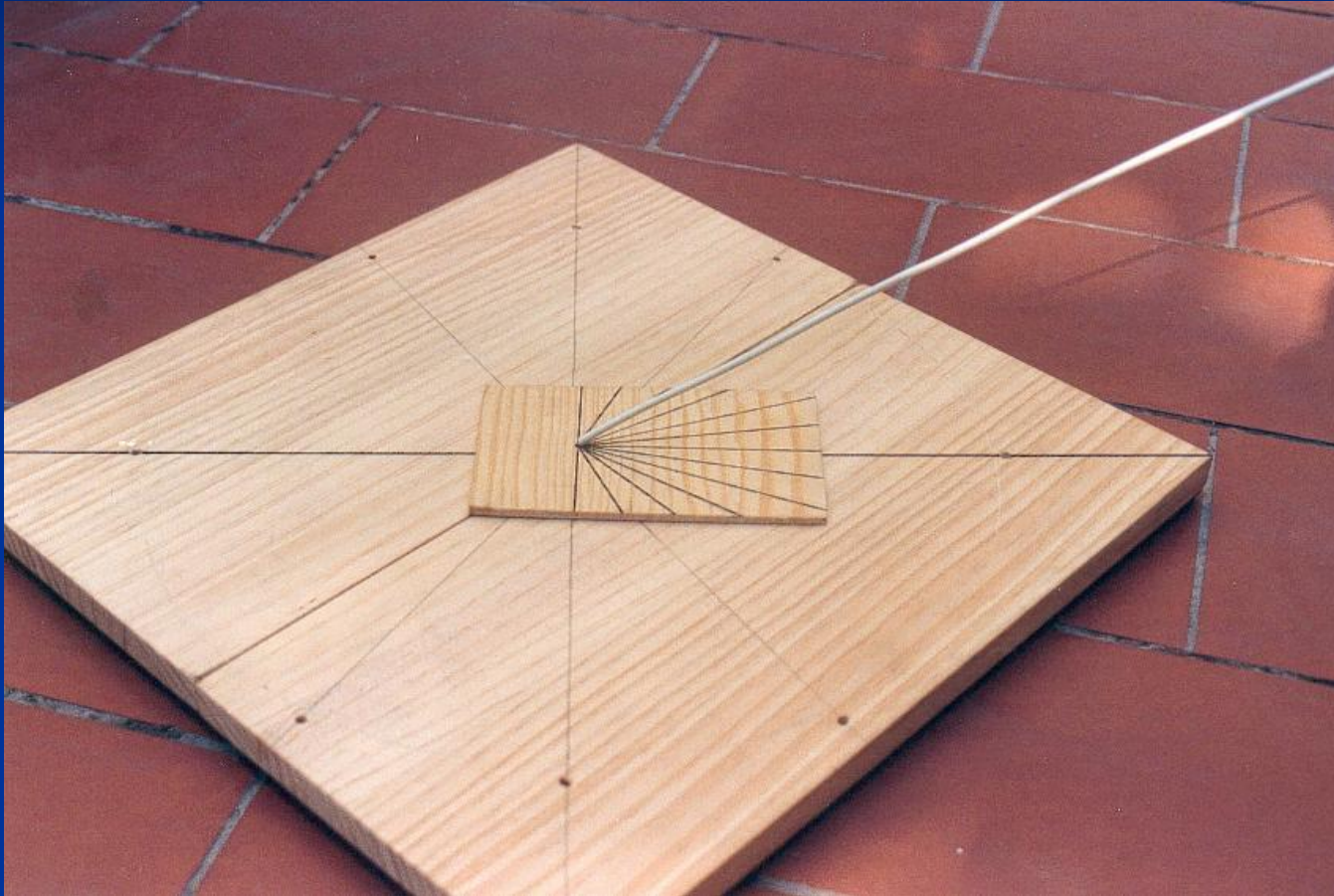



...and the vertically oriented E-W sundial

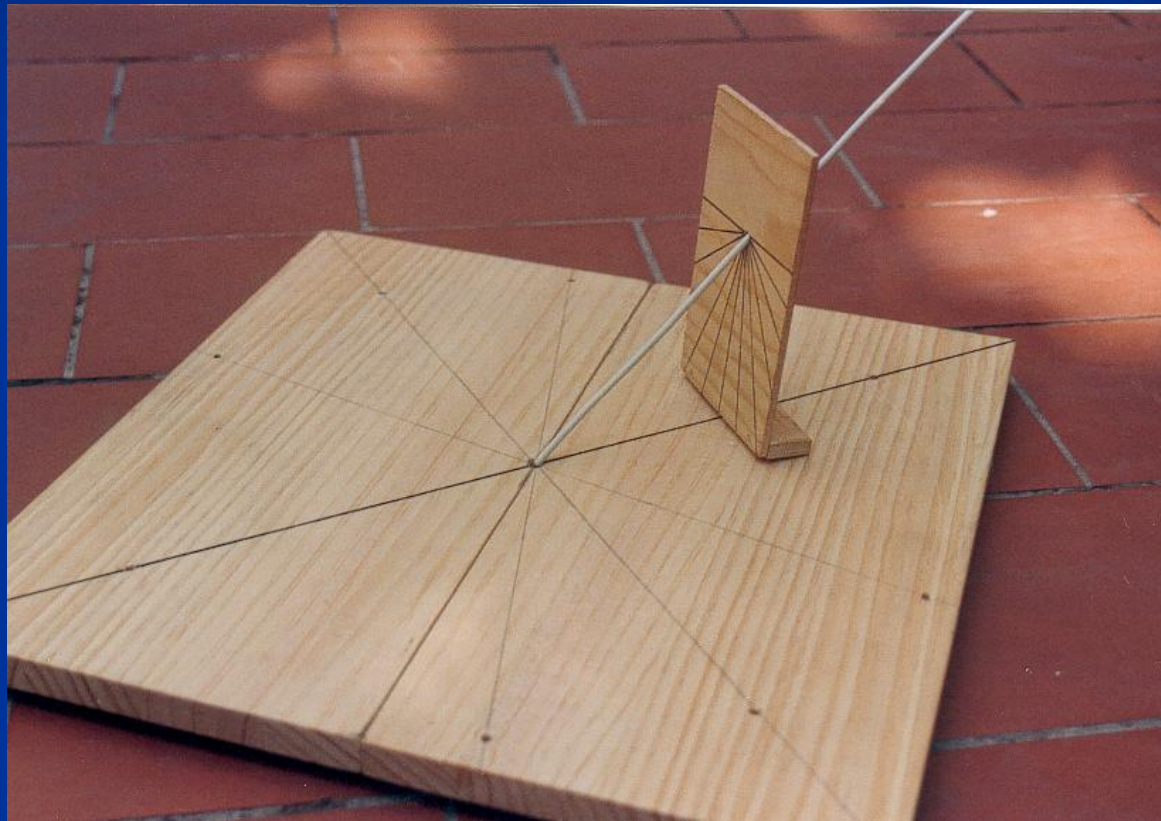

... and with the Sun (or with a flashlight) we observe the model acting like a sundial

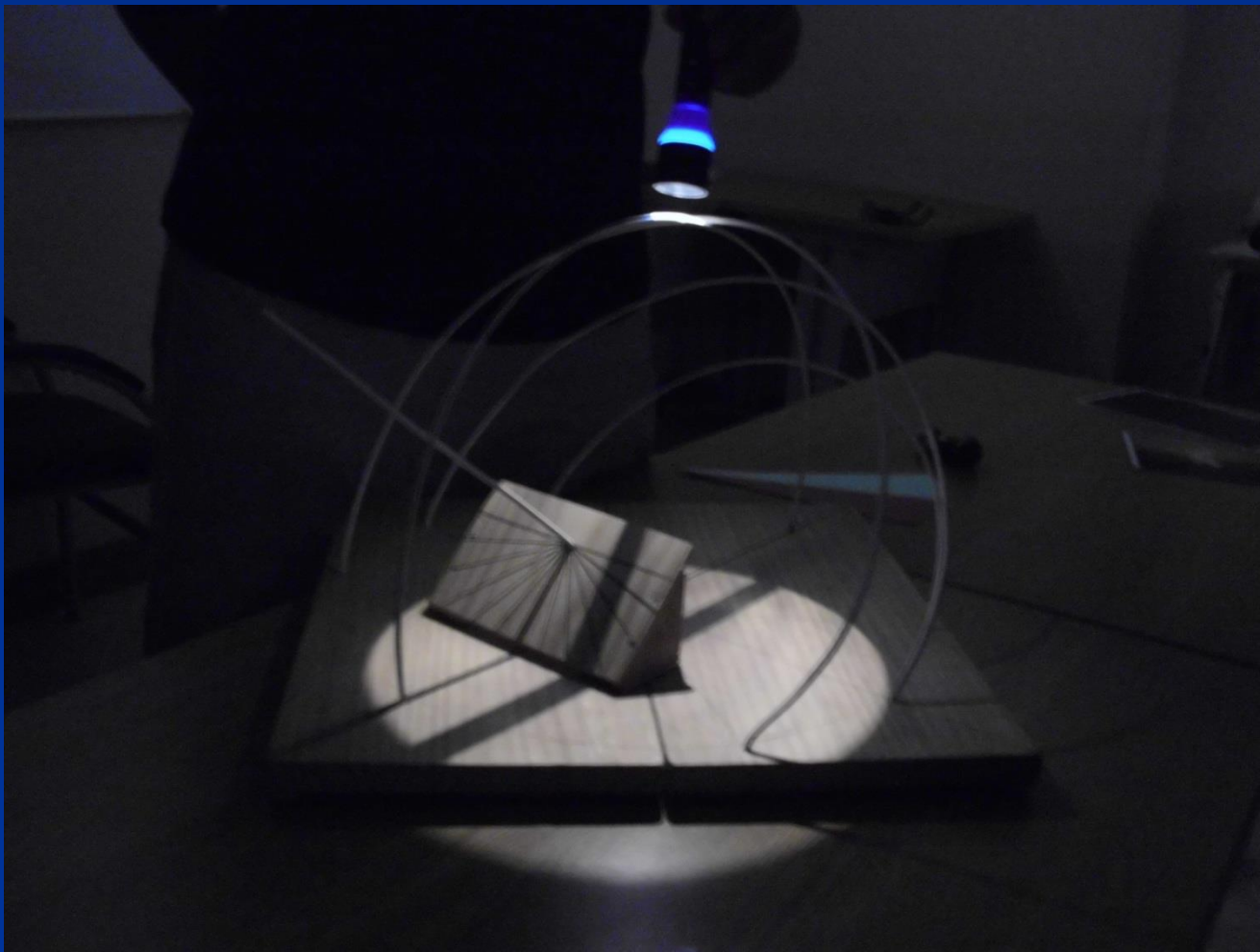

# The three sundials in the model

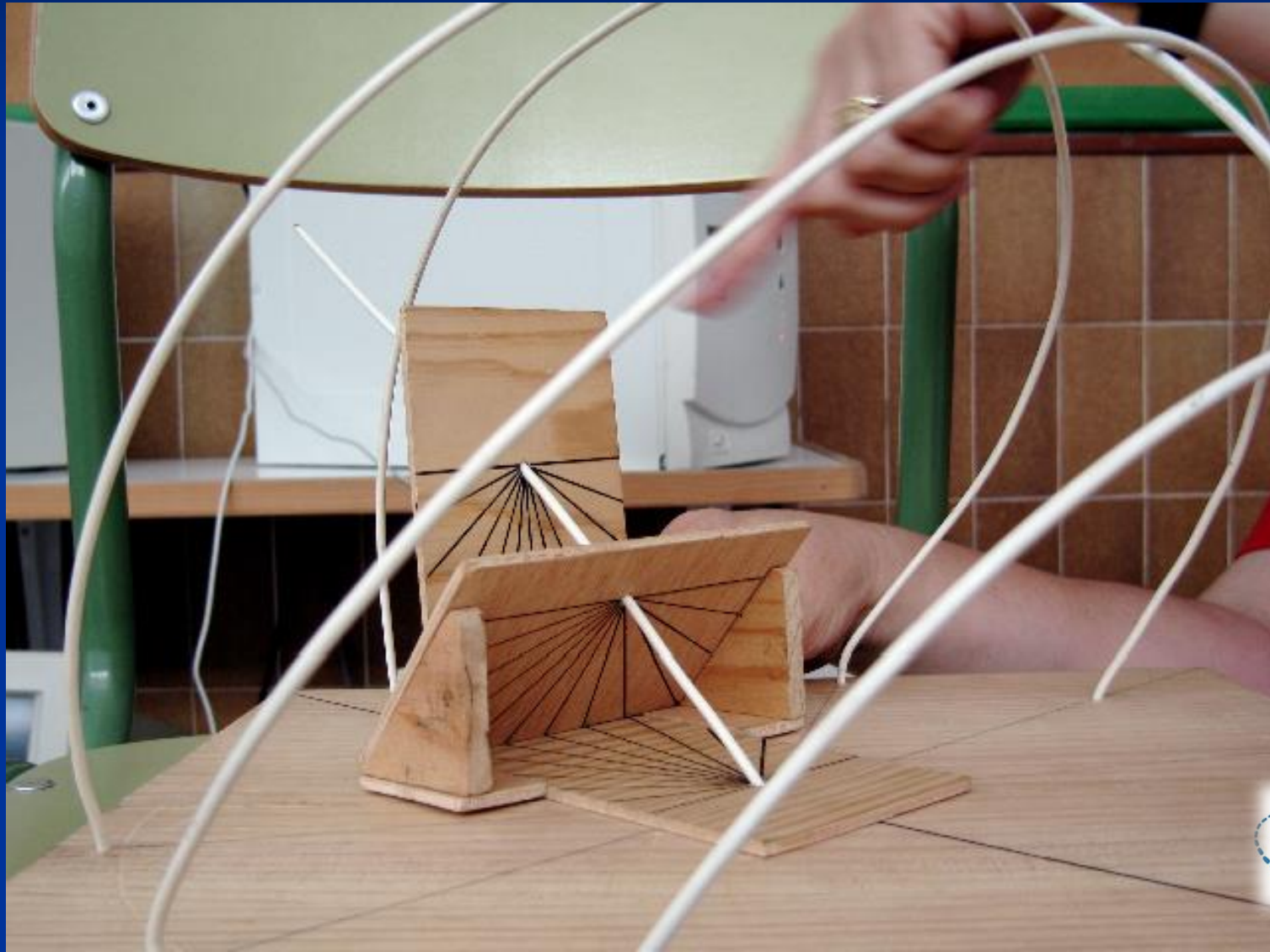

# Activity 4: Let's see how to build a very simple “equatorial” sundial!

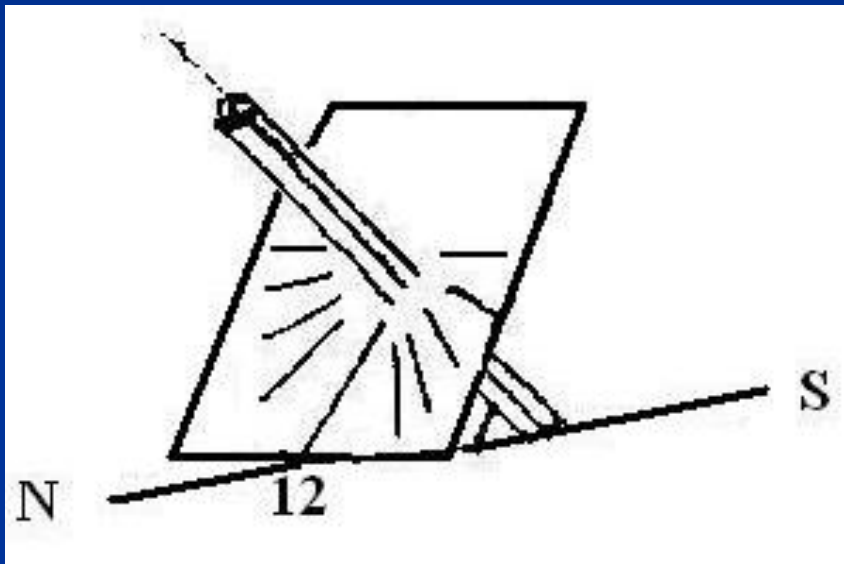

■ Northern Hemisphere

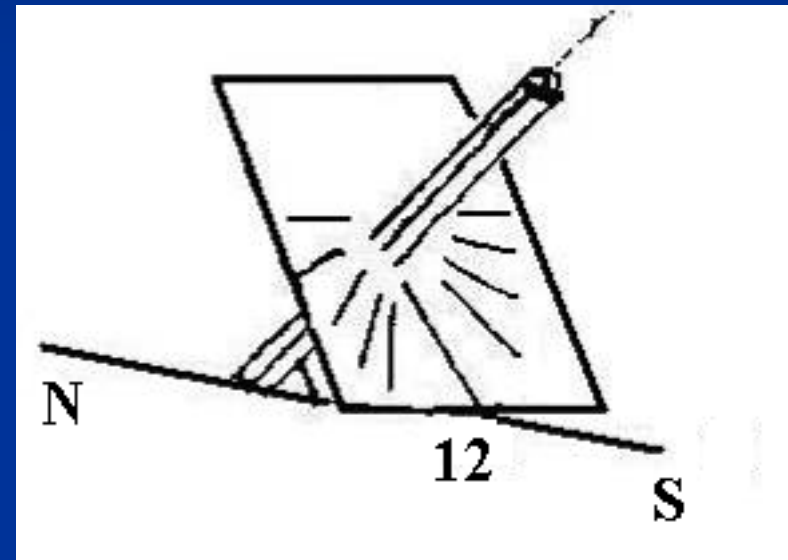

■ Southern Hemisphere



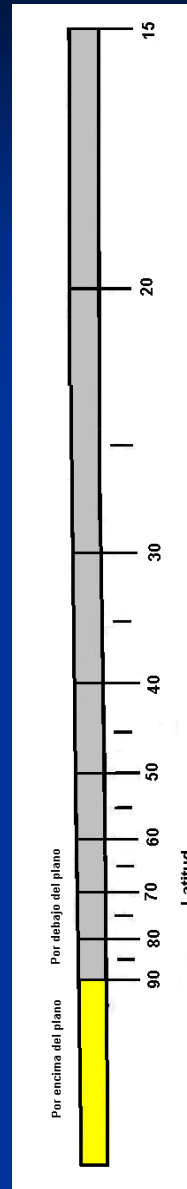
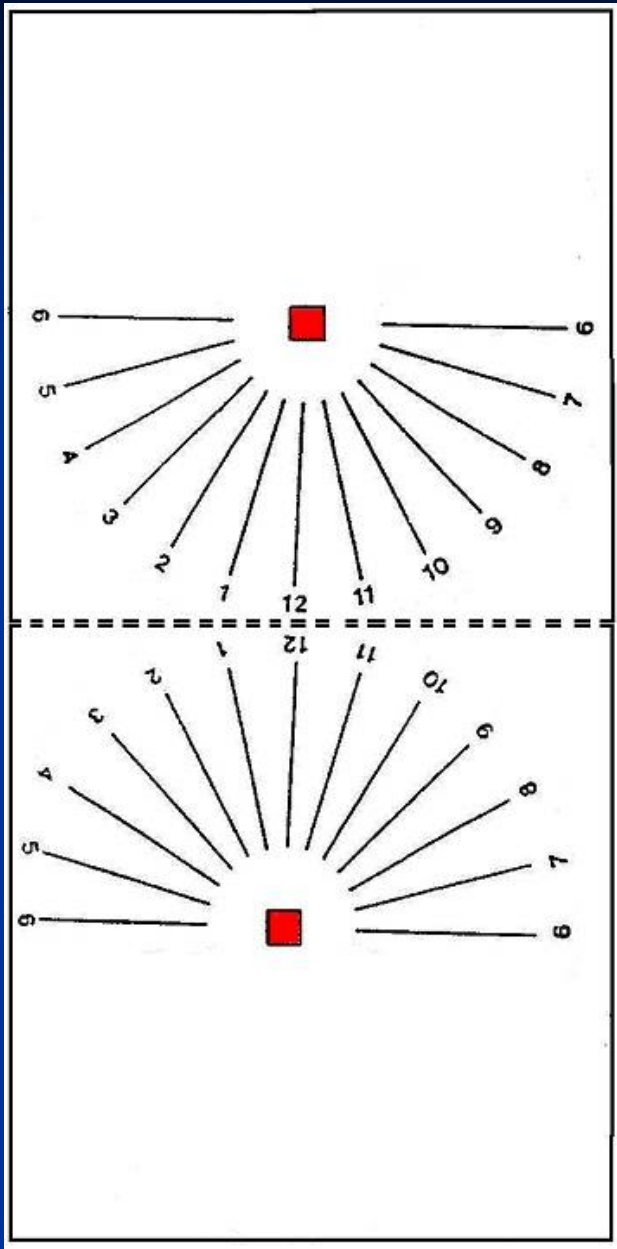

## Activity 4: “equatorial” sundial!

- Fold the pattern along the dotted line
- Cut the stylus for your latitude. The yellow part goes above the plane

# Activity 5: How to Read the Time

**Solar Time + Total Adjustment = Wristwatch Time**

**Total Adjustment =**

- **Longitude Adjustment**
- **Summer / Winter Adjustment**
- **Equation of Time Adjustment**



# Activity 5: Read the time, Longitude Adjustment

- The world is divided into 24 time zones from the Zero or Greenwich meridian.
- We must know the local longitude and "Standard" meridian longitude of your area.
- Use sign + to the East and sign - to the West.
- Write longitudes in h, m and s ( $1^{\circ}=4m$ ).

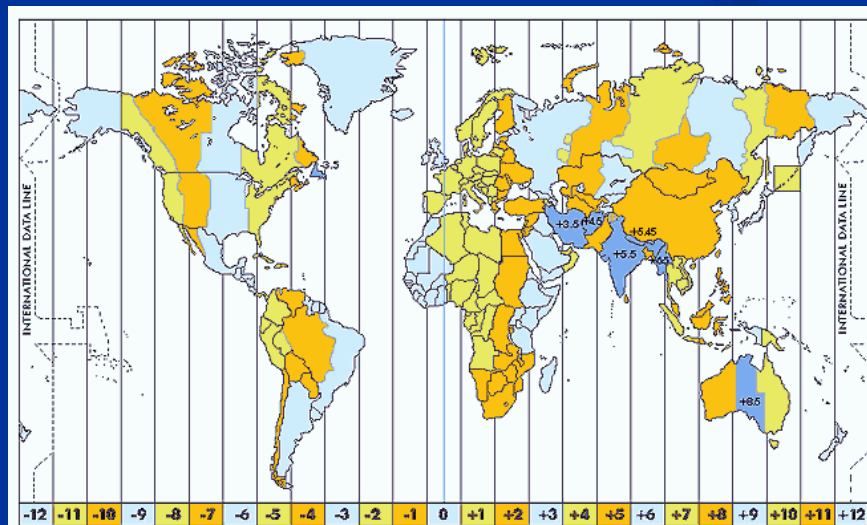

## Activity 5: Read the time, Summer / Winter Adjustment

- Many countries add an hour in summer.
- This change of clocks for summer / winter is a decision of the government of the country.





# Activity 5: Read the time, Equation of Time Adjustment

- The Earth revolves around the Sun according the law of areas, i.e. not a constant motion. We define the average time (of mechanical watches) as the average over a full year.
- The equation of time is the difference between "Real Solar Time" and "Mean Time" in minutes of time

day	Jan	Feb	Mar	Apr	May	Jun	Jul	Aug	Sep	Oct	Nov	Dec
1	+3m 33s	+13m 35s	+12m 22s	+3m 54s	-2m 54s	-2m 12s	+3m 50s	+6m 21s	+0m 2s	-10m 18s	-16m 24s	-11m 1s
6	+5m 50s	+14 m 5s	+11m 17s	+2m 27s	-3m 23s	-1m 22s	+4m 45s	+5m 54s	-1m 23s	-11m 51s	-16m 22s	-9m 1s
11	+7m 55s	+14m 14s	+10m 3s	+1m 4s	-3m 38s	-0m 23s	+5m 29s	+5m 13s	-3m 21s	-13m 14s	-15m 31s	-6m 49s
16	+9m 45s	+14m 4s	+8m 40s	-0m 11s	-3m 40s	+0m 39s	+6m 3s	+4m 17s	-5m 7s	-14m 56s	-15m 15s	-4m 27s
21	+11m 18s	+13m 37s	+7m 12s	-1m 17s	-3m 27s	+1m 44s	+6m 24s	+3m 10s	-6m 54s	-15m 21s	-14m 10s	-1m 58s
26	+12m 32s	+12m 54s	+5m 42s	-2m 12s	-3m	+2m 49s	+6m 32s	+1m 50s	-8m 38s	-16m 1s	-12m 44s	+0m 31s
31	+13m 26s		+4m 12s		-2m 21s		+6m 24s	+0m 21s		-16m 22s		+2m 57s



# Activity 5: Reading Time

*Example 1: Barcelona (Spain) on May 24<sup>th</sup>*

Adjustment	Comment	Result
1. Longitude	Barcelona is in the same "standard" zone as Greenwich. Its longitude is $2^{\circ} 10' E = 2.17^{\circ} E = -8.7 \text{ m}$ ( $1^{\circ}$ is equivalent to 4 m)	-8.7 m
2. Summer Time	May has daylight saving of +1 h	+ 60 m
3. Equation of Time	We read the table for May 24 <sup>th</sup>	-3.4 m
Total		+47.9 m

For example at 12h of solar time (noon), our watches indicated  
(Solar time)  $12\text{h} + 47.9 \text{ m} = 12\text{h } 47.9 \text{ m}$  (wristwatch time)



# Activity 5: Reading Time

*Example 2: Tulsa, Oklahoma (USA) November 16<sup>th</sup>*

Adjustment	Comment	Result
1. Longitude	The standard meridian of Tulsa is 90 ° W. Its longitude is 95° 58' W = 96 ° W, so it is 6° W from the standard meridian (1° is equivalent to 4 m)	+24 m
2. Winter Time	November 16 <sup>th</sup> does not have daylight saving added	0
3. Equation of Time	We read the table for November 16 <sup>th</sup>	-15.3 m
Total		+ 8.7 m

For example at 12h solar time (noon), our watches will indicate (Solar time) 12h + 8.7 m = 12h 8.7 m (Wristwatch time)



the model serves to orientate us ...

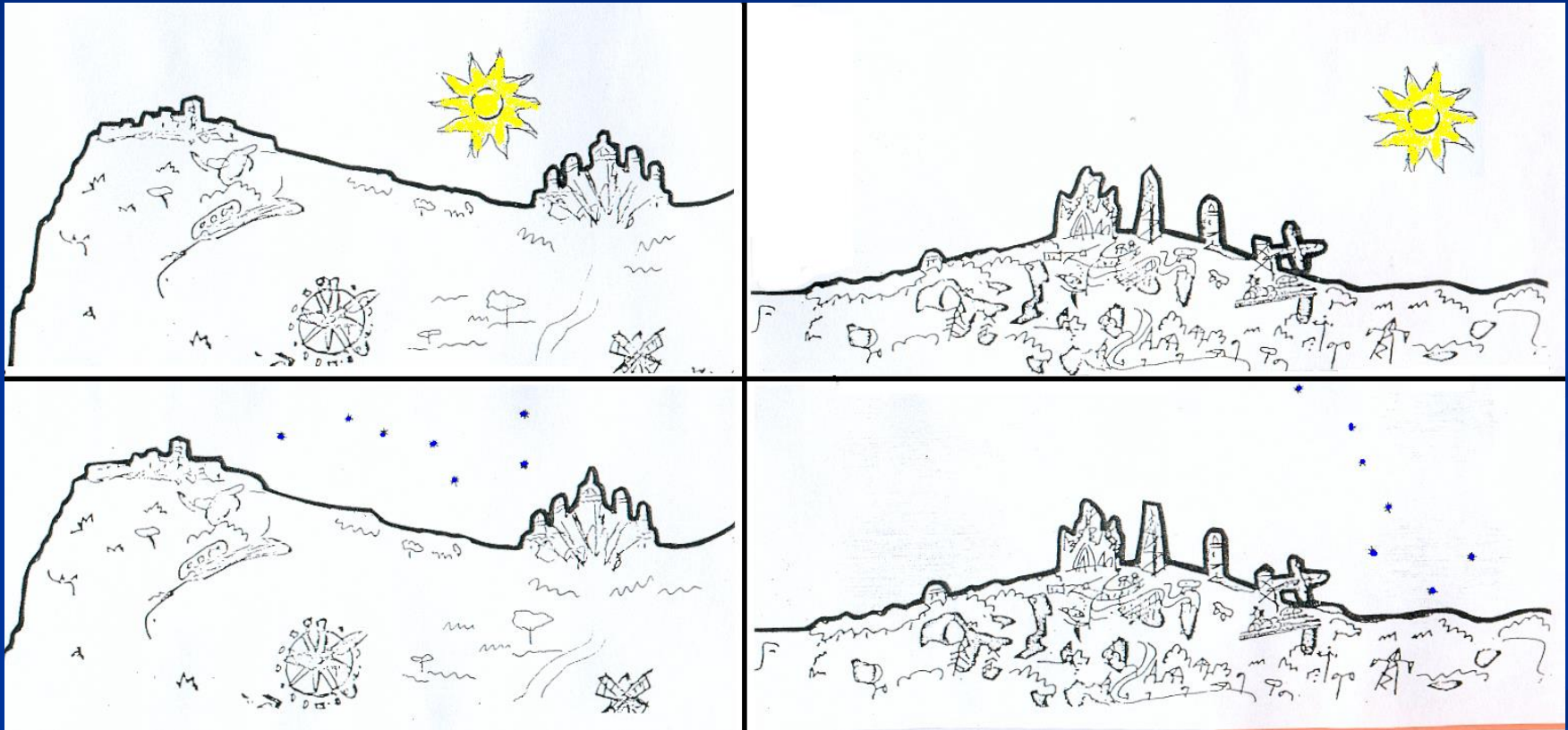



... to observe and understand ...



# Conclusions

- We understand the "views" of the model from inside and outside
- We reach levels of abstraction that let us read books and make comments
- We feel oriented to the real horizon
- We see that the sunrise is not always due East and that the Sunset is not always due West



**Thank you very much  
for your attention!**

