

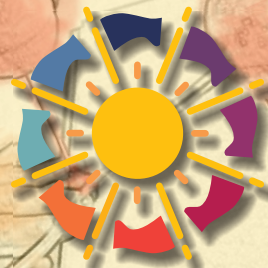

# Geometry of light and shadows



INTERNATIONAL  
YEAR OF LIGHT  
2015





# **Geometry of Light and Shadows**

Astronomy for everyday life

NASE

Network for Astronomy Education in School  
Working Group of the Commission on Education and  
Development of the IAU

Editors: Rosa M. Ros and Mary Kay Hemenway



First edition: January 2015

©: NASE 2015-01-31

©:Text by: Francis Berthomieu, Beatriz García, Mary Kay Hemenway, Ricardo Moreno, Jay M. Pasachoff,, Rosa M. Ros, Magda Stavinschi, 2014

Editor: Rosa M. Ros and Mary Kay Hemenway

Graphic Design: Silvina Pérez

Printed in UE

ISBN: 978-84-15771-47-0

Printed by:  
Albedo Fulldome, S.L



# Index

Introduction	3
History of Astronomy	5
Solar System	22
Local Horizon and Sundials	43
Stellar, solar and lunar demonstrators	60
Earth-moon-sun system: Phases and eclipses	85
Young Astronomer Briefcase	99
Planets and Exoplanets	117
Preparing for Observing	139



# Introduction

**Teaching is not to just transferring knowledge, it is creating the possibility of producing it,  
Paulo Freire**

The Network for Astronomy School Education, NASE, has as its main objective the development of quality training courses in all countries to strengthen astronomy at different levels of education. It proposes to incorporate issues related to the discipline in different curriculum areas to introduce young people in science through the approach of the study of the Universe. The presence of astronomy in schools is essential and goes hand in hand with teacher training.

In the NASE proposed activities the active participation, observation, and making models to better understand the scientific contents are promoted on three fundamental premises: the workshops should be at zero cost, the activities can be completed in time for a class and a special laboratory at the institution is not needed. Since all schools have a schoolyard, it is proposed to use this court as "astronomy lab" to make observations and transform the students into the major players in the task of learning.

The basis of Astronomy is the scientific study of light, either from the radiation coming from celestial objects (produced or reflected by them) or from the physical study of it. The applications of electromagnetic energy in technology have meant a fundamental change in the lives of human beings.

A remarkable series of milestones in the history of the science of light allows us to ensure that their study intersects with science and technology. In 1815, in France Fresnel exhibited the theory of wave nature of light; in 1865, in England Maxwell described the electromagnetic theory of light, the precursor of relativity; in 1915, in Germany Einstein developed general relativity which confirmed the central role of light in space and time, and in 1965, in the United States Penzias and Wilson discovered the cosmic microwave background, fossil remnant of the creation of universe. Moreover, 2015 will mark 1000 years since the great works of Ibn al-Haytham on optics, published during the Islamic Golden Age.

That light, electromagnetic energy in general, is a necessary condition for life, has marked the evolution on our planet. It has modified our lives and constitutes a powerful tool that we need to know to use it properly.

NASE provides two monographic texts **Geometry of Light and Shadows** and **Cosmic Lights**, to show how "light" can be used in teaching concepts in different areas of the natural sciences, from mathematics to biology and to create awareness of the great achievements and discoveries of mankind related to light, as well as the need for responsible use of this energy on Earth.

Although the texts can be used independently, covering both will include more aspects of astronomy and astrophysics found in the education programs around the Globe.

To learn more about the courses developed in different countries, activities and new courses that have arisen after the initial course, we invite the reader to go to the NASE website (<http://www.naseprogram.org>). The program is not limited to provide initial training, but tends to form working groups with local teachers, who continue to support themselves and include new teachers as they create new materials and new activities which are made available to the international network on



the Internet. The supplementary material of NASE offers a universe of possibilities to the instructor who has followed the basic courses, allowing them to expand the knowledge and select new activities to develop at their own courses and institutions.

The primary objective of NASE is to provide Astronomy activities to all to understand and enjoy the process of assimilation of new knowledge.

Finally, we thank all the authors for their help in preparation of materials. Also we emphasize the great support received for translations and assistance for the two versions of this book (Spanish/ English): Ligia Arias, Barbara Castanheira, Lara Eakins, Jaime Fabregat, Keely Finkelstein, Irina Marinova Nestor Marinozzi, Mentuch Erin Cooper, Isa Oliveira, Cristina Padilla, Silvina Pérez, Claudia Romagnolli, Colette Salyk, Viviana Sebben, Oriol Serrano, Ruben Trillo and Sarah Tuttle.

# History of Astronomy

**Jay Pasachoff, Magda Stavinschi, Mary Kay Hemenway**

International Astronomical Union, Williams College (Massachusetts, USA),  
Astronomical Institute of the Romanian Academy (Bucarest, Romania), University  
of Texas (Austin, USA)

## Summary

This short survey of the History of Astronomy provides a brief overview of the ubiquitous nature of astronomy at its origins, followed by a summary of the key events in the development of astronomy in Western Europe to the time of Isaac Newton.

## Goals

- Give a schematic overview of the history of astronomy in different areas throughout the world, in order to show that astronomy has always been of interest to all the people.
- List the main figures in the history of astronomy who contributed to major changes in approaching this discipline up to Newton: Tycho Brahe, Copernicus, Kepler and Galileo.
- Conference time constraints prevent us from developing the history of astronomy in the present day, but more details can be found in other chapters of this book

## Pre-History

With dark skies, ancient peoples could see the stars rise in the eastern part of the sky, move upward, and set in the west. In one direction, the stars moved in tiny circles. Today, for those in the northern hemisphere, when we look north, we see a star at that position – the North Star, or Polaris. It isn't a very bright star: 48 stars in the sky are brighter than it, but it happens to be in an interesting place. In ancient times, other stars were aligned with Earth's North Pole, or sometimes, there were no stars in the vicinity of the pole.

Since people viewed the sky so often, they noticed that a few of the brighter objects didn't rise and set exactly with the stars. Of course, the Moon was by far the brightest object in the night sky. It rose almost an hour later each night, and appeared against a different background of stars. Its shape also changed in cycles (what we now call phases).

But some of these lights in the sky moved differently from the others. These came to be called wanderers or planets by the Greeks. Virtually every civilization on Earth noticed, and named, these objects.

Some ancient people built monuments such as standing circles, like Stonehenge in England,

or tombs such as the ones in Menorca in Spain that aligned with the Southern Cross in 1000 BC. The Babylonians were great recorders of astronomical phenomena, but the Greeks built on that knowledge to try to "explain" the sky.

## The Greeks

Most ancient Greeks, including Aristotle (384 BCE – 322 BCE), thought that Earth was in the center of the universe, and it was made of four elements: Earth, Air, Fire, and Water. Beyond the Earth was a fifth element, the aether (or quintessence), that made up the points of light in the sky.

How did these wanderers move among the stars? Mostly, they went in the same direction that the stars went: rising in the east and moving toward the west. But sometimes, they seemed to pause and go backwards with respect to the stars. This backward motion is called "retrograde" motion, to tell it apart from the forward motion, called "prograde."

The Greek astronomer Claudius Ptolemy (c. CE 90 – c. CE 168) worked in Alexandria in North Africa in the second century CE. Ptolemy wanted to be able to predict the positions of planets and came up with a mathematical solution. Following Aristotle, he placed the Earth at the center of the universe. The Moon and the planets go around it in nested circles that got bigger with distance from Earth. What if the planets really move on small circles whose centers are on the big circles? Then, on some of the motion on the small circles, they'd be moving faster backwards than the centers of these circles move forward. For those of us on Earth, we'd see the planets move backwards.

Those small circles are called "epicycles," and the big circles are called "deferents." Ptolemy's idea of circles moving on circles held sway over western science for over a thousand years. Going from observation to theory using mathematics was a unique and important step in the development of western science.

Although they didn't have the same names for the objects they observed, virtually every culture on Earth watched the skies. They used the information to set up calendars and predict the seasonal cycles for planting, harvesting, or hunting as well as religious ceremonies. Like the Greeks, some of them developed very sophisticated mathematics to predict the motions of the planets or eclipses, but this does not mean that they attempted what we would call a scientific theory. Here are some examples:

## Africa

The standing stones at Nabta in the Nubian Desert pre-date Stonehenge by 1000 years. Egyptians used astronomy to align their pyramids as well as extend their religious beliefs to include star lore. Petroglyphs at Namoratunga (Kenya) share aspects of modern cattle brands. Star lore comes from all areas of Africa, from the Dogon region of Mali, to West Africa, to Ethiopia, to South Africa.

## Islamic Astronomy

Many astronomical developments were made in the Islamic world, particularly during the Islamic Golden Age (8<sup>th</sup>-15<sup>th</sup> centuries), and mostly written in the Arabic language. It was developed most in the Middle East, Central Asia, Al-Andalus, North Africa, and later in the Far East and India. A significant number of stars in the sky, such as Aldebaran and Altair, and astronomical terms such as alidade, azimuth, almucantar, are still referred to by their Arabic names. Arabs invented Arabic numbers, including the use of zero. They were interested in finding positions and time of day (since it was useful for prayer services). They made many discoveries in optics as well. Many works in Greek were preserved for posterity through their translations to Arabic.

The first systematic observations in Islam are reported to have taken place under the patronage of Al-Maâmun (786-833 CE). Here, and in many other private observatories from Damascus to Baghdad, meridian degrees were measured, solar parameters were established, and detailed observations of the Sun, Moon, and planets were undertaken.

Instruments used by the Islamic astronomy were: celestial globes and armillary spheres, astrolabes, sundials and quadrants.



Fig. 1: Arabic astrolabe

## The Americas

### North America

Native peoples of North America also named their constellations and told sky stories which were passed down through oral tradition. Some artifacts, such as stone wheels or building

alignments, remain as evidence of their use of astronomy in every-day life.

## Mayan Astronomy

The Maya were a Mesoamerican civilization, noted for the only known fully developed written language of the pre-Columbian Americas, as well as for its art, architecture, mathematical and astronomical systems. Initially established during the Pre-Classic period (c. 2000 BCE to 250 CE), Mayan cities reached their highest state of development during the Classic period (c. 250 CE to 900 CE), and continued throughout the Post-Classic period until the arrival of the Spanish. The Mayan peoples never disappeared, neither at the time of the Classic period decline nor with the arrival of the Spanish conquistadors and the subsequent Spanish colonization of the Americas.

Mayan astronomy is one of the most known ancient astronomies in the world, especially due to its famous calendar, wrongly interpreted now as predicting the end of the world. Maya appear to be the only pre-telescopic civilization to demonstrate knowledge of the Orion Nebula as being fuzzy, i.e. not a stellar pinpoint.

The Maya were very interested in zenithal passages, the time when the Sun passes directly overhead. The latitudes of most of their cities being below the Tropic of Cancer, these zenithal passages would occur twice a year equidistant from the solstice. To represent this position of the Sun overhead, the Maya had a god named Diving God.



Fig. 2: Chichén Itzá(Mexico) is an important archaeological remains of the Maya astronomy.

Venus was the most important astronomical object to the Maya, even more important to them than the Sun. The Mayan calendar is a system of calendars and almanacs used in the Mayan civilization of pre-Columbian Mesoamerica, and in some modern Maya communities in highland Guatemala and Oaxaca, Mexico.

Although the Mesoamerican calendar did not originate with the Mayan, their subsequent extensions and refinements of it were the most sophisticated. Along with those of the Aztecs,

the Mayan calendars are the best documented and most completely understood.

## Aztec Astronomy

They were certain ethnic groups of central Mexico, particularly those groups who spoke the Nahuatl language and who dominated large parts of Mesoamerica in the 14th, 15th and 16th centuries, a period referred to as the late post-classic period in Mesoamerican chronology.

Aztec culture and history is primarily known through archeological evidence found in excavations such as that of the renowned Templo Mayor in Mexico City and many others, from indigenous bark paper codices, from eyewitness accounts by Spanish conquistadors or 16<sup>th</sup> and 17<sup>th</sup> century descriptions of Aztec culture and history written by Spanish clergymen and literate Aztecs in the Spanish or Nahuatl language.

The Aztec Calendar, or Sun Stone, is the earliest monolith that remains of the pre-Hispanic culture in Central and South America. It is believed that it was carved around the year 1479. This is a circular monolith with four concentric circles. In the center appears the face of Tonatiuh (Sun God), decorated with jade and holding a knife in his mouth. The four suns or earlier "worlds" are represented by square-shaped figures flanking the Fifth Sun, in the center. The outer circle consists of 20 areas that represent the days of each of the 18 months that comprised the Aztec calendar. To complete the 365-day solar year, the Aztecs incorporated 5 sacrificial, or Nemontemi, days.

Like almost all ancient peoples, the Aztecs grouped into associations the apparent bright stars (constellations): Mamalhuaztli (Orion's Belt), Tianquiztli (the Pleiades), Citlaltlactli (Gemini), Citlalcolotl (Scorpio) and Xonecuilli (The Little Dipper, or Southern Cross for others, etc.). Comets were called "the stars that smoke."

The great periods of time in the Aztec cosmology are defined by the eras of different suns, each of whose end was determined by major disasters such as destruction by jaguars, hurricanes, fire, flood or earthquakes.

## Inca Astronomy

Inca civilization is a civilization pre-Columbian Andean Group. It starts at the beginning of the 13<sup>th</sup> century in the basin of Cuzco in Peru and the current then grows along the Pacific Ocean and the Andes, covering the western part of South America. At its peak, it extends from Colombia to Argentina and Chile, across Ecuador, Peru and Bolivia.

The Incas considered their King, the Sapa Inca, to be the "child of the Sun". Its members identified various dark areas or dark nebulae in the Milky Way as animals, and associated their appearance with the seasonal rains. Its members identified various dark areas or dark nebulae in the Milky Way as animals, and associated their appearance with the seasonal rains

The Incas used a solar calendar for agriculture and a lunar calendar for the religious holidays. According to chronicles of the Spanish conquistadors, on the outskirts of Cuzco in present

day Peru there was a big public schedule that consisted of 12 columns each 5 meters high that could be seen from afar. With it, people could set the date. They celebrated two major parties, the Inti Raymi and Capac Raymi, the summer and winter solstice respectively.

They had their own constellations: the Yutu (Partridge) was the dark zone in the Milky Way that we call the Coal Sack. They called the Pleiades cluster Qollqa. With the stars of the Lyra constellation they did a drawing of one of the most known animals to them, and named it Little Silver Llama or colored Llama, whose brightest star (Vega) was Urkuchillay, although according to others, that was the name of the whole constellation. Moreover there were the Machacuay (snake), the Hamp'atu (toad), the Atoq (Fox), the Kuntur, etc.

Major cities were drawn following celestial alignments and using the cardinal points.

On the outskirts of Cuzco there was an important temple dedicated to the Sun (Inti), from which came out some lines in radial shape that divided the valley in 328 Temples. That number is still a mystery, but one possible explanation relates it to the astronomy: it coincides with the days that contain twelve lunar months. And the 37 days that are missing until the 365 days of the solar year coincides with the days that the Pleiades cluster is not observable from Cuzco.

## India

The earliest textual mention that is given in the religious literature of India (2nd millennium BCE) became an established tradition by the 1st millennium BCE, when different ancillary branches of learning began to take shape.

During the following centuries a number of Indian astronomers studied various aspects of astronomical sciences, and global discourse with other cultures followed. Gnomons and armillary spheres were common instruments.

The Hindu calendar used in ancient times has undergone many changes in the process of regionalization, and today there are several regional Indian calendars, as well as an Indian national calendar. In the Hindu calendar, the day starts with local sunrise. It is allotted five "properties," called angas.

The ecliptic is divided into 27 nakshatras, which are variously called lunar houses or asterisms. These reflect the moon's cycle against the fixed stars, 27 days and 72 hours, the fractional part being compensated by an intercalary 28th nakshatra. Nakshatra computation appears to have been well known at the time of the Rig Veda (2nd to 1st millennium BCE).

## China

The Chinese were considered as the most persistent and accurate observers of celestial phenomena anywhere in the world before the Arabs. Detailed records of astronomical observations began during the Warring States period (4th century BCE) and flourished from the Han period onwards.

Some elements of Indian astronomy reached China with the expansion of Buddhism during the Later Han dynasty (25-220 CE), but the most detailed incorporation of Indian astronomical thought occurred during the Tang Dynasty (618-907).

Astronomy was revitalized under the stimulus of Western cosmology and technology after the Jesuits established their missions. The telescope was introduced in the 17th century. Equipment and innovation used by Chinese astronomy: armillary sphere, celestial globe, the water-powered armillary sphere and the celestial globe tower.

Chinese astronomy was focused more on the observations than on theory. According to writings of the Jesuits, who visited Beijing in the 17th century, the Chinese had data from the year 4,000 BCE, including the explosion of supernovae, eclipses and the appearance of comets.

In the year 2300 BCE, they developed the first known solar calendar, and in 2100 BCE recorded a solar eclipse. In 1200 BCE they described sunspots, calling them "specks dark" in the Sun. In 532 BCE, they left evidence of the emergence of a supernova star in the Aquila constellation, and in the 240 and 164 BCE passages of Halley comet. In 100 BCE Chinese invented the compass with which they marked the direction north.

And in more recent times, they determined the precession of the equinoxes as one degree every 50 years, recorded more supernovae and found that the tail of comets always points in the opposite direction to the Sun's position

In the year 1006 CE they noted the appearance of a supernova so bright that could be seen during the day. It is the brightest supernova that has been reported. And in 1054, they observed a supernova, the remnants of which would later be called the Crab Nebula.

Their celestial sphere differed from the Western one. The celestial equator was divided into 28 parts, called "houses", and there were a total of 284 constellations with names such as Dipper, Three Steps, Supreme Palace, Tripod, Spear or Harpoon. Chinese New Year starts on the day of the first new moon after the sun enters the constellation Aquarius.

The polymath Chinese scientist Shen Kuo (1031-1095 CE) was not only the first in history to describe the magnetic-needle compass, but also made a more accurate measurement of the distance between the Pole Star and true North that could be used for navigation. Shen Kuo and Wei Pu also established a project of nightly astronomical observation over a period of five successive years, an intensive work that would even rival the later work of Tycho Brahe in Europe. They also charted the exact coordinates of the planets on a star map for this project and created theories of planetary motion, including retrograde motion.

## Western Europe

Following the fall of Rome, the knowledge compiled by the Greeks was barely transmitted through the work of monks who often copied manuscripts that held no meaning for them.



Eventually, with the rise of Cathedral schools and the first universities, scholars started to tackle the puzzles that science offers. Through trade (and pillaging), new manuscripts from the East came through the Crusades, and contact with Islamic scholars (especially in Spain) allowed translations to Latin to be made. Some scholars attempted to pull the information into an order that would fit it into their Christian viewpoint.

## Mathematical genius: Nicholas Copernicus of Poland

In the early 1500s, Nicholas Copernicus (1473 – 1543) concluded that Universe would be simpler if the Sun, rather than the Earth, were at its center. Then the retrograde motion of the planets would occur even if all the planets merely orbited the Sun in circles. The backward motion would be an optical illusion that resulted when we passed another planet. Similarly, if you look at the car to your right while you are both stopped at a traffic light, if you start moving first, you might briefly think that the other car is moving backwards.

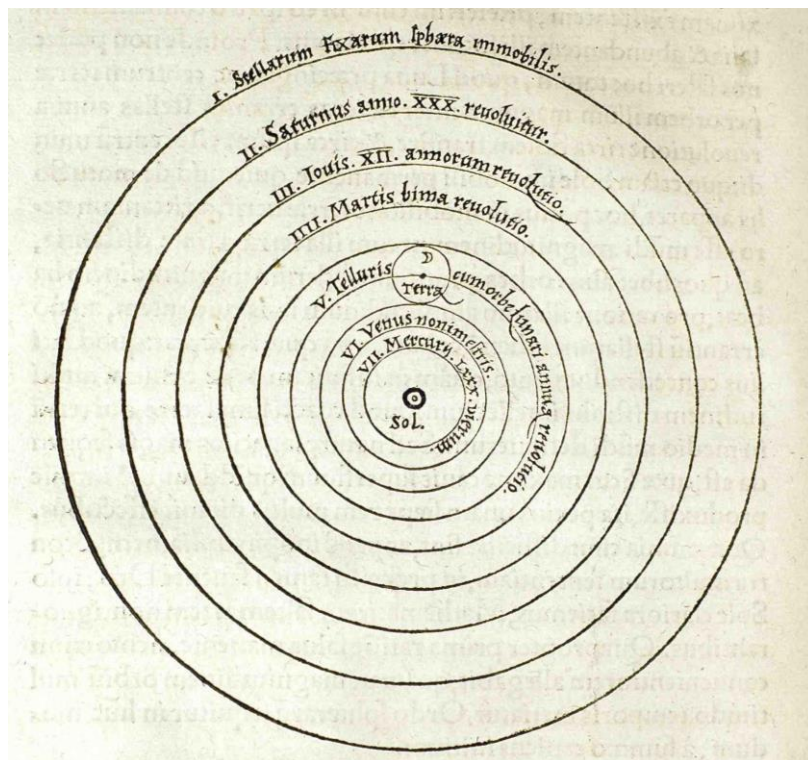

Fig. 3: Copernicus's diagram first showing the Sun at the center of what we therefore now call the Solar System. This diagram is from the first edition of *De Revolutionibus Orbium Celestium* (On the Revolutions of the Celestial Orbs), published in 1543.

Copernicus shared his ideas with mathematicians, but did not publish them until a young scientist, Georg Rheticus, convinced him and arranged for the publication in another town. A printed copy of *De Revolutionibus Orbium Celestium* arrived just as Copernicus was dying in 1543. He may have never seen the unsigned preface written by the publisher that suggested that the book was a mathematical way to calculate positions, not the actual truth. Following Aristotle, Copernicus used circles and added some epicycles. His book followed the structure of Ptolemy's book, but his devotion to mathematical simplicity was influenced by Pythagorus.

Copernicus's book contains (figure 3) perhaps the most famous diagram in the history of science. It shows the Sun at the center of a series of circles. Copernicus calculated the speeds at which the planets went around the Sun, since he knew which went fastest in the sky. Thus he got the planets in the correct order: Mercury, Venus, Earth, Mars, Jupiter, Saturn, and he got the relative distances of the planets correct also. But, his calculations really didn't predict the positions of the planets much better than Ptolemy's method did.

In England, Leonard Digges wrote a book, in English, about the Earth and the Universe. In 1576, his son Thomas wrote an appendix in which he described Copernicus's new ideas. In the appendix, an English-language version of Copernicus's diagram appeared for the first time (figure 4). Digges also showed the stars at many different distances from the solar system, not just in one celestial sphere.

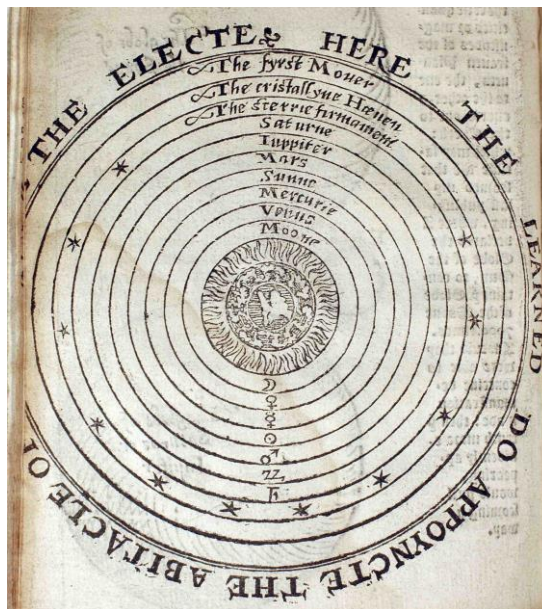

Fig 4. The first Copernican diagram in English, from Thomas Digges's appendix to *A prognostication everlasting*, a book by his father first published in 1556. It contained only a Ptolemaic diagram. Thomas Digges's appendix first appeared in 1576; this diagram is from the 1596 printing.

## Observational genius: Tycho Brahe of Denmark

The Danish aristocrat Tycho Brahe (1546 – 1601) took over an island off the coast of Copenhagen, and received rent from the people there. On this island, Hven, he used his wealth to build a great observatory with larger and better instruments. Though these were pre-telescopic instruments, they were notable for allowing more precise measurements of the positions of the stars and planets than had previously been possible.

Tycho ran his home as a forerunner of today's university, with visiting scientists coming to work with him. He made better and better observing devices to measure the positions of stars and planets, and kept accurate records.

But in his scientific zeal, he neglected some of his duties to his monarch, and when a new king and queen came in, he was forced out. He chose to move to Prague, on the continent of Europe, taking even his printing presses and pages that had already been printed, his records, and his moveable tools.

Tycho succeeded in improving the accuracy of scientific observations. His accurate observations of a comet at various distances showed him that the spheres did not have to be nested with the Earth at the center. So, he made his own model of the universe -a hybrid between Ptolemy's and Copernicus': the Sun and the Moon revolve around the Earth, while the other planets revolve around the Sun. Tycho still had circles, but unlike Aristotle, he allowed the circles to cross each other.

We value Tycho mainly for the trove of high-quality observations of the positions among the stars of the planet Mars. To join him in Prague, Tycho invited a young mathematician, Johannes Kepler. It is through Kepler that Tycho's fame largely remains.

## Using Mathematics: Johannes Kepler of Germany

As a teacher in Graz, Austria, young Johannes Kepler (1571 – 1630) remembered his childhood interest in astronomy, fostered by a comet and the lunar eclipse that he had seen. He realized that there are five solid forms made of equally-shaped sides, and that if these solids were nested and separated by spheres, they could correspond to the six known planets. His book on the subject, *Mysterium Cosmographicum* (Mystery of the Cosmos), published in 1596, contained one of the most beautiful diagrams in the history of science (figure 5). In it, he nested an octahedron, icosahedron, dodecahedron, tetrahedron, and cube, with eight, twelve, twenty, four, and six sides, respectively, to show the spacing of the then-known planets. The diagram, though very beautiful, is completely wrong

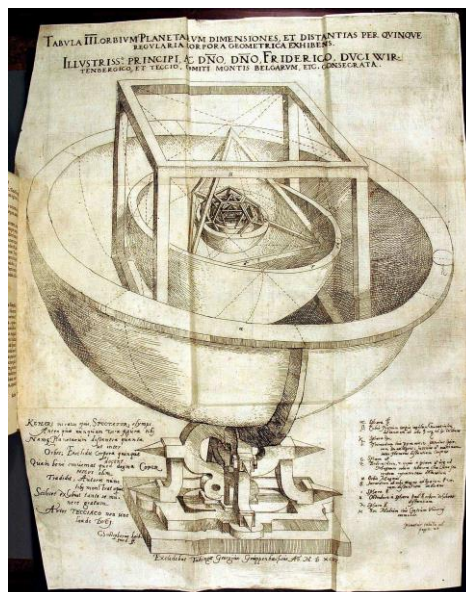

Fig. 5: Kepler's foldout diagram from his *Mysterium Cosmographicum* (Mystery of the Cosmos), published in 1596. His thinking of the geometric arrangement of the solar system was superseded in the following decade by

his arrangements of the planets according to the first two of his three laws of planetary motion.

But Kepler's mathematical skill earned him an interview with Tycho. In 1600, he became one of several assistants to Tycho, and he made calculations using the data that Tycho had amassed. Then Tycho went to a formal dinner and drank liberally. As the story goes, etiquette prevented him from leaving the table, and he wound up with a burst bladder. His quick and painful death was carefully followed in a diary, and is well documented.

But Kepler didn't get the data right away. For one thing, the data was one of the few valuable things that Tycho's children could inherit, since Tycho had married a commoner and was not allowed to bequeath real property. But Kepler did eventually get access to Tycho's data for Mars, and he tried to make it fit his calculations. To make his precise calculations, Kepler even worked out his own table of logarithms.

The data Kepler had from Tycho was of the position of the Mars in the sky, against a background of stars. He tried to calculate what its real motion around the Sun must be. For a long while, he tried to fit a circle or an egg-shaped orbit, but he just couldn't match the observations accurately enough. Eventually, he tried a geometrical figure called an ellipse, a sort of squashed circle. It fit! The discovery is one of the greatest in the history of astronomy, and though Kepler first applied it to Mars and other planets in our solar system, we now apply it even to the hundreds of planets we have discovered around other stars.

Kepler's book of 1609, *Astronomia Nova* (The New Astronomy), contained the first two of his three laws of motion:

*Kepler's first law: The planets orbit the Sun in ellipses, with the Sun at one focus.*

*Kepler's second law: A line joining a planet and the Sun sweeps out equal areas in equal times.*

An ellipse is a closed curve that has two key points in it; they are known as the foci. To draw your own ellipse, put two dots on a piece of paper; each is a focus. Then take a piece of string longer than the distance between the foci. Tape them down on the foci. Next, put a pencil in the string, pulling it taut, and gently move it from side to side. The curve you generate will be one side of an ellipse; it is obvious how to move the pencil to draw the other side. This experiment with the string shows one of the key points defining an ellipse: the sum of the distances from a point on the ellipse to each focus remains constant. A circle is a special kind of ellipse where the two dots are on top of each other.

Kepler kept searching for harmonies in the motions of the planets. He associated the speeds of the planets with musical notes, the higher notes corresponding to the faster-moving planets, namely, Mercury and Venus. In 1619, he published his major work *Harmonices Mundi* (The Harmony of the Worlds). In it (figure 6), he included not only musical staves with notes but also what we call his third law of planetary motion:

*Kepler's Third Law of Planetary Motion: The square of the period of a planet's orbit around the sun is proportional to the cube of the size of its orbit.*

Astronomers tend to measure distances between planets in terms of the Astronomical Units, which corresponds to the average distance between the Earth and the Sun, or 150 million kilometers.



Fig.6: From Kepler's *Harmonices Mundi* (The Harmony of the World), published in 1619.

Mercury	0.387 AU	0.240 year
Venus	0.723 AU	0.615 year
Earth	1 AU	1 year
Mars	1.523 AU	1.881 years
Jupiter	5.203 AU	11.857 years
Saturn	9.537 AU	29.424 years

Table 1: Distances from the Sun and periods of the planets in Kepler's time.

Try squaring the first column and cubing the second column. You will see that they are pretty equal. Any differences come from the approximation, not from the real world, though with more decimal places the influences of the other planets could be detected.

## Discoveries with the Telescope: Galileo Galilei of Italy

The year 2009 was the International Year of Astronomy, declared first by the International Astronomical Union, then by UNESCO, and finally by the General Assembly of the United Nations. Why? It commemorated the use of the telescope on the heavens by Galileo 400 years previously, in 1609.

Galileo (1564 - 1642) was a professor at Padua, part of the Republic of Venice. He heard of a Dutch invention that could make distant objects seem closer. Though he hadn't seen one, he figured out what lenses it must have contained and he put one together. He showed his device to the nobles of Venice as a military and commercial venture, allowing them to see ships farther out to sea than ever before. His invention was a great success.



Fig. 7a: One of Galileo's two surviving telescopes came to the Franklin Institute in Philadelphia in 2009, on its first visit to the United States. Note that the outer part of the lens is covered with a cardboard ring. By hiding the outer part of the lens, which was the least accurate part, Galileo improved the quality of his images. (Photo: Jay M. Pasachoff). Fig. 7b: A page from Galileo's *Sidereus Nuncius* (The Starry Messenger), published in 1610, showing an engraving of the Moon. The book was written in Latin, the language of European scholars. It included extensive coverage of the relative motion of the four major moons of Jupiter.

Then he had the idea of turning the telescope upward. Though the telescope was hard to use, had a very narrow field of view, and was hard to point, he succeeded in seeing part of the Moon and realizing that there was a lot of structure on it. Because of his training in drawing in Renaissance Italy, he realized that the structure represented light and shadow, and that he was seeing mountains and craters. From the length of the shadows and how they changed with changing illumination from the Sun, he could even figure out how high they were. A few months earlier, the Englishman Thomas Harriot had pointed a similar telescope at the Moon, but he had drawn only some hazy scribbles and sketches. But Harriot wasn't interested in publication or glory, and his work did not become known until after his death.

One lens Galileo used for his discoveries remains, cracked, in the Museum of the History of Science in Florence, Italy, and two full telescopes he made survive, also there (figure 7a). Galileo started writing up his discoveries in late 1609. He found not only mountains and craters on the moon but also that the Milky Way was made out of many stars, as were certain asterisms. Then, in January 1610, he found four "stars" near Jupiter that moved with it and that changed position from night to night. That marked the discovery of the major moons of Jupiter, which we now call the Galilean satellites. He wrote up his discoveries in a slim book called *Sidereus Nuncius* (The Starry Messenger), which he published in 1610 (figure 7b). Since Aristotle and Ptolemy, it had been thought that the Earth was the only center of revolution. And Aristotle had been thought to be infallible. So the discovery of Jupiter's satellites by showing that Aristotle could have been wrong was a tremendous blow to the geocentric notion, and therefore a strong point in favor of Copernicus' heliocentric theory.

Galileo tried to name the moons after Cosmo de' Medici, his patron, to curry favor. But those names didn't stick. Within a few years, Simon Marius proposed the names we now use. (Marius may even have seen the moons slightly before Galileo, but he published much later.) From left to right, they are Io, Europa, Ganymede, and Callisto (figure 9). Even in a small, amateur telescope, you can see them on a clear night, and notice that over hours they change positions. They orbit Jupiter in periods of about two to sixteen days.

Even in the biggest and best ground-based telescopes, astronomers could not get a clear view of structure on the surfaces of the Galilean satellites. Only when the NASA satellites Pioneer 10 and 11, and then Voyager 1 and 2, flew close to the Jupiter system did we see enough detail on the satellites to be able to characterize them and their surfaces. From ground-based and space-based observations, astronomers are still discovering moons of Jupiter, though the newly discovered ones are much smaller and fainter than the Galilean satellites.

Galileo used his discoveries to get a better job with a higher salary, in Florence. Unfortunately, Florence was closer to the Papal authority in Rome, serving as bankers to the Pope, and was less liberal than the Venetian Republic. He continued to write on a variety of science topics, such as sunspots, comets, floating bodies. Each one seemed to pinpoint an argument against some aspect of Aristotle's studies. He discovered that Venus had phases - which showed that Venus orbited the Sun. This did not prove that Earth orbited the Sun, since Tycho's hybrid cosmology would explain these phases. But, Galileo saw it as support of Copernicus.



Fig. 8: In 2009, to commemorate the 400th anniversary of Galileo's first use of the telescope on the heavens, a plaque was put on a column at the top of the Campanile, a 15th-century tower (re-erected in the early 20th century after it collapsed in 1902) in Venice. The commemoration here is of Galileo's demonstrating his telescope to the nobles of Venice by observing ships relatively far out at sea; it was before he turned his telescope upward. The writing on the plaque can be translated approximately as "Galileo Galilei, with his spyglass, on August 21, 2009, enlarged the horizons of man, 400 years ago." (Photo: Jay M. Pasachoff)

In 1616, he was told by Church officials in Rome not to teach Copernicanism, that the Sun rather than the Earth was at the center of the Universe. He managed to keep quiet for a long time, but in 1632 he published his *Dialogo* (Dialogue on Two Chief World Systems) that had three men discussing the heliocentric and geocentric systems. He had official permission to publish the book, but the book did make apparent his preference for the Copernican heliocentric system. He was tried for his disobedience and sentenced to house arrest, where he remained for the rest of his life.

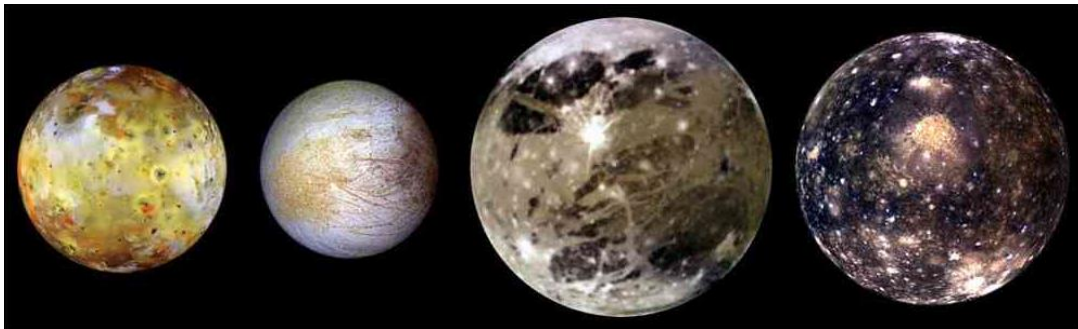

Fig. 9: Galileo himself would have been amazed to see what his namesake spacecraft and its predecessors showed from the "Medician satellites" that he discovered in 1609. Here they show in images at their true relative scale. From left to right, we see Io, newly resurfaced with two dozen continually erupting volcanoes. Second is Europa, a prime suspect for finding extraterrestrial life because of the ocean that is under the smooth ice layer that we see. Third is Ganymede, the largest moon in the solar system, showing especially a fascinatingly grooved part of its surface. And at right is Callisto, farther out than the others and covered with hard ice that retains the scarring from overlapping meteorite strikes that occurred over billions of years. (Photo:NASA, Galileo Mission, PIA01400)

## The New Physics: Isaac Newton of England

Many believe that the three top physicists of all time are: Isaac Newton, James Clerk Maxwell, and Albert Einstein. A summary: Newton discovered the law of gravity, Clerk Maxwell unified electricity and magnetism, and Einstein discovered special and general relativity.

In a mostly true story, young Isaac Newton (1642 – 1727) was sent home from Cambridge University to Woolsthorpe, near Lincoln, in England, when the English universities were closed because of plaque. While there, he saw an apple fall off an apple tree, and he realized that the same force that controlled the apple's fall was, no doubt, the same force that controlled the motion of the Moon.

Eventually, Newton was back at Trinity College, Cambridge, on the faculty. In the meantime, a group of scientists in London got together in a coffeehouse to form a society (now the Royal Society), and young Edmond Halley was sent to Cambridge to confirm a story that a brilliant mathematician, Isaac Newton, could help them with an important scientific question. The trip from London to Cambridge by stagecoach was a lot longer and more difficult than the hour's train trip is nowadays.

Halley asked Newton if there were a force that fell off with the square of the distance, what shape would an orbit have? And Newton replied that it would be an ellipse. Excited, Halley asked if he had proved it, and Newton said it was on some papers he had. He said he couldn't find them, though perhaps he was merely waiting time to judge whether he really wanted to turn over his analysis. Anyway, Newton was moved to write out some of his mathematical conclusions. They led, within a few years, to his most famous book, the *Philosophiæ Naturalis Principia Mathematica* (the Mathematical Principles of Natural Philosophy), where what they then called Philosophy includes what we now call Science.



Newton's *Principia* came out in 1687, in Latin. Newton was still a college teacher then; it was long before he was knighted for his later work for England's mint. Halley had to pay for the printing of Newton's book, and he championed it, even writing a preface.

The *Principia* famously included Newton's law that showed how gravity diminishes by the square of the distance, and his proof of Kepler's laws of planetary orbits. The book also includes Newton's laws of motion, neatly shown as "laws," in Latin, whereas Kepler's laws are buried in his text. Newton's laws of motions are:

*Newton's first law of motion: A body in motion tends to remain in motion, and a body at rest tends to remain at rest.*

*Newton's second law of motion (modern version): force = mass times acceleration*

*Newton's third law of motion: For every action, there is an equal and opposite reaction.*

Newton laid the foundation though mathematical physics that led to the science of our modern day.

## Astronomy Research Continues

Just as the ancient peoples were curious about the sky and wanted to find our place in the universe, astronomers of the present day have built on the discoveries of the past with the same motivation. Theoretical and observational discoveries moved our understanding of our place in the universe from Ptolemy's geocentric vision, to Copernicus's heliocentric hypothesis, to the discovery that the solar system was not in the center of our galaxy, to our understanding of galaxies distributed across the universe.

Contemporary astronomy grapples with the programs of finding the nature of dark matter and dark energy. Einstein's theory of relativity indicates that not only is our galaxy not in the center of the universe, but that the "center" is rather meaningless. More recent discoveries of hundreds of exoplanets orbiting other stars have shown how unusual our solar system may be. New theories of planet formation parallel new observations of unexpected planetary systems. The path of discovery lays before astronomers of the modern age just as it did for those from thousands or hundreds of years ago.

## Bibliography

- Hoskin, M. (editor), *Cambridge Illustrated History of Astronomy*, Cambridge University Press, 1997.
- Pasachoff, J and Filippenko A, *The Cosmos: Astronomy in the New Millennium, 4th ed.*, Cambridge University Press 2012.

## Internet Sources

- <http://www.solarcorona.com>
- <http://www.astrosociety.org/education/resources/multiprint.html>
- <http://www2.astronomicalheritage.net>

# Solar System

**Magda Stavinschi**

International Astronomical Union, Astronomical Institute of the Romanian Academy (Bucarest, Romania)

## Summary

Undoubtedly, in a universe where we talk about stellar and solar systems, planets and exoplanets, the oldest and the best-known system is the solar one. Who does not know what the Sun is, what planets are, comets, asteroids? But is this really true? If we want to know about these types of objects from a scientific point of view, we have to know the rules that define this system.

Which bodies fall into these categories (according to the resolution of the International Astronomical Union of 24 August 2006)?

- planets
- natural satellites of the planets
- dwarf planets
- other smaller bodies: asteroids, meteorites, comets, dust, Kuiper belt objects, etc.

By extension, any other star surrounded by bodies according to the same laws is called a stellar system.

What is the place of the Solar system in the universe? These are only some of the questions we will try to answer now.

## Goals

- Determine the place of the Sun in the universe.
- Determine which objects form the solar system
- Find out details of the various bodies in the solar system, in particular of the most prominent among them

## Solar System

**What is a system?** A system is, by definition, an ensemble of elements (principles, rules, forces, etc.), mutually interacting in keeping with a number of principles or rules.

**What is a Solar System?** To define it we shall indicate the elements of the ensemble: the Sun and all the bodies surrounding it and connected to it through the gravitational force.

**What is the place of the Solar System in the universe?** The Solar System is situated in one of the exterior arms of our Galaxy, also called the Milky Way. This arm is called the Orion Arm. It is located in a region of relatively small density.

The Sun, together with the entire Solar system, is orbiting around the center of our Galaxy, located at a distance of 25,000 – 28,000 light years (approximately half of the galaxy radius),

with an orbital period of approximately 225-250 million years (the galactic year of the Solar system). The travel distance along this circular orbit is approximately 220 km/s, while the direction is oriented towards the present position of the star Vega.

Our Galaxy consists of approximately 200 billion stars, together with their planets, and over 1000 nebulae. The mass of the entire Milky Way is approx. 750-1000 billion times bigger than that of the Sun, and the diameter is approx. 100,000 light years.

Close to the Solar System is the system Alpha Centauri (the brightest star in the constellation Centaurus). This system is actually made up of three stars, two stars that are a binary system (Alpha Centauri A and B), that are similar to the Sun, and a third star, Alpha Centauri C, which is probably orbiting the other two stars. Alpha Centauri C is a red dwarf with a smaller luminosity than the sun, and at a distance of 0.2 light-years from the other two stars. Alpha Centauri C is the closest star to the Sun, at a distance of 4.24 light-years that is why it is also called "Proxima Centauri".

Our galaxy is part of a group of galaxies called the Local Group, made up of two large spiral galaxies and at about 50 other ones.

Our Galaxy has the shape of a huge spiral. The arms of this spiral contain, among other things, interstellar matter, nebulae, and young clusters of stars, which are born out of this matter. The center of the galaxy is made up of older stars, which are often found in clusters that are spherical in shape, known as globular clusters. Our galaxy numbers approximately 200 such groups, from among which only 150 are well known. Our Solar system is situated 20 light years above the symmetry equatorial plane and 28,000 light years away from the galactic center.

The galaxy center is located in the direction of the Sagittarius Constellation, 25,000 – 28,000 light years away from the Sun.

## Sun

The age of the Sun is approx. 4.6 billion years. At present the Sun has completed about half of its main evolutionary cycle. During the main stage of its evolution the Sun's hydrogen core turns into helium through nuclear fusion. Every second in the Sun's nucleus, over four million tons of matter are converted into energy, thus generating neutrinos and solar radiation.

### The Sun's life cycle

In about 5 billion years the Sun will turn into a red giant, and then into a white dwarf, a period when it will give birth to a planetary nebula. Finally, it will exhaust its hydrogen, which will lead to radical changes, the total destruction of the Earth included. The solar activity, more specifically its magnetic activity, produces a number of phenomenon including solar spots on its surface, solar flares and solar wind variations, which carry matter into the entire Solar system and even beyond.

The Sun's composition is made up of mostly hydrogen and helium. Hydrogen accounts for approx. 74%, and helium accounts for approximately 25% of the Sun, while the rest is made up of heavier elements, such as oxygen, and carbon.



Fig. 1: The Sun

## The formation and the evolution of the Solar System

The birth and the evolution of the solar system have generated many fanciful theories in the past. Even in the beginning of the scientific era, the source of the Sun's energy and how the Solar System formed was still a mystery. However new advances in the space era, the discovery of other worlds similar to our Solar system, as well as advances in nuclear physics, have all helped us to better understand the fundamental processes that take place inside a star, and how stars form.

The modern accepted explanation for how the Sun and Solar System formed (as well as other stars) was first proposed back in 1755 by Emmanuel Kant and also separately by Pierre-Simon Laplace. According to this theory stars form in large dense clouds of molecular hydrogen gas. These clouds are gravitationally unstable and collapse into smaller denser clumps; in the case of the Sun this is called the "solar nebula", these initial dense clumps then collapse even more to form stars and a disk of material around them that may eventually become planets. The solar nebula may have originally been the size of 100 AU and had a mass 2-3 times bigger than that of the Sun. Meanwhile as the nebula was collapsing more and more, the conservation of angular momentum made the nebula spin faster as it collapsed, and caused the center of the nebula to become increasingly warmer. This took place about 4.6 billion years ago. It is generally considered that the solar system looks entirely different today than it originally did when it was first forming.

But let's take a better look at the Solar System, as it is today.

## Planets

We shall use the definition given by the International Astronomical Union at its 26th General Meeting, which took place in Prague, in 2006.

In the Solar System a planet is a celestial body that:

1. is in orbit around the Sun,
2. has sufficient mass to assume hydrostatic equilibrium (a nearly round shape), and
3. has "cleared the neighborhood" around its orbit.

A non-satellite body fulfilling only the first two of these criteria is classified as a "dwarf planet". According to the IAU, "planets and dwarf planets are two distinct classes of objects". A non-satellite body fulfilling only the first criterion is termed a "small solar system body" (SSSB).

Initial drafts planned to include dwarf planets as a subcategory of planets, but because this could potentially have led to the addition of several dozens of planets into the Solar system, this draft was eventually dropped. In 2006, it would only have led to the addition of three (Ceres, Eris and Makemake) and the reclassification of one (Pluto). Now, we recognize has five dwarf planets: Ceres, Pluto, Makemake, Haumea and Eris.

According to the definition, there are currently eight planets and five dwarf planets known in the Solar system. The definition distinguishes planets from smaller bodies and is not useful outside the Solar system, where smaller bodies cannot be found yet. Extrasolar planets, or exoplanets, are covered separately under a complementary 2003 draft guideline for the definition of planets, which distinguishes them from dwarf stars, which are larger.

Let us present them one by one:

## MERCURY

Mercury is the closest planet to the Sun and the smallest planet in the Solar system. It is a terrestrial<sup>1</sup> planet in the inner solar system. It gets its name from the Roman god Mercury.

It has no natural satellite. It is one of the five planets that can be seen from the Earth with the naked eye. It was first observed with the telescope only in the 17th century. More recently it was surveyed by two space probes: Mariner 10 (three times in 1974-1975) and Messenger (two times in 2008).

Although it can be seen with the naked eye, it is not easily observable, precisely because it is the closest planet to the Sun. Its location on the sky is very close to the Sun and it can only be well observed around the elongations, a little before sunrise and a little after sunset. However, space missions have given us sufficient information, proving surprisingly that Mercury is very similar to the Moon.

It is worth mentioning several characteristics of the planet: it is the smallest one in the Solar system and the closest one to the Sun. It has the most eccentric orbit ( $e = 0.2056$ ) and also the most inclined one against the ecliptic ( $i = 7^{\circ}005$ ). Its synodic period is of 115.88 days, which means that three times a year it is situated in a position of maximum elongation west of the Sun (it is also called "the morning star" and when it is three times in maximum elongation position east of the Sun it is called "the evening star". In either of these cases, the elongation does not exceed  $28^{\circ}$ .

It has a radius of 2440 km, making it the smallest planet of the Solar system, smaller even than two of Jupiter's Galilean satellites: Ganymede and Callisto. A density of  $5.427 \text{ g/cm}^3$  makes it the densest planet after the Earth ( $5.5 \text{ g/cm}^3$ ). Iron might be the main heavy element (70% Iron and 30% rocky matter), which contributes to Mercury's extremely high density. It is generally asserted that Mercury has no atmosphere, which is not quite correct as its atmosphere is extremely rarified.

---

<sup>1</sup> A **terrestrial planet** is a planet that is primarily composed of silicate rocks. Within the Solar system, the terrestrial (or telluric) planets are the inner planets closest to the Sun.

Mercury is the only planet (besides the Earth) with a significant magnetic field, which, although it is of the order of 1/100 of that of the terrestrial magnetic field, it is sufficient enough to create a magnetosphere which extends up to 1.5 planetary radii, compared to 11.5 radii in the case of the Earth. Finally, there is another analogy with the Earth: the magnetic field is created by a dynamo effect and the magnetic is also dipolar like Earth's, with a magnetic axis inclined at 11° to the rotation axis.

On Mercury the temperatures vary enormously. When the planet passes through the perihelion, the temperature can reach 427° C on the equator at noon, namely enough to bring about the fusion of a metal to zinc. However, immediately after night fall, the temperature can drop down to 183°C, which makes the diurnal variation rise to 610 C!. No other planet undergoes such a difference, which is due either to the intense solar radiation during the day, the absence of a dense atmosphere, and the duration of the Mercurian day (the interval between dawn and dusk is almost three terrestrial months), long enough time to stock heat (or, similarly, cold during an equally long night).

<b>Orbital characteristics, Epoch J2000</b>	
Aphelion	69,816,900 km, 0.466697 AU
Perihelion	46,001,200 km, 0.307499 AU
Semi-major axis	57,909,100 km, 0.387098 AU
Eccentricity	0.205630
Orbital period	87.969 days, (0.240 85 years), 0.5 Mercury solar day
Synodic Period	115.88 days
Average orbital speed	47.87 km/s
Mean anomaly	174.796°
Inclination	7.005° to Ecliptic
Longitude of ascending node	48.331°
Argument of perihelion	29.124°
Satellite	None

<b>Physical Characteristics</b>			
Mean radius	2,439.7 ± 1.0 km; 0.3829 Earths		
Flattening	0		
Surface area	7.48 × 10 <sup>7</sup> km <sup>2</sup> ; 0.147 Earths		
Volume	6.083 × 10 <sup>10</sup> km <sup>3</sup> ; 0.056 Earths		
Mass	3.3022 × 10 <sup>23</sup> kg; 0.055 Earths		
Mean density	5.427 g/cm <sup>3</sup>		
Equatorial surface gravity	3.7 m/s <sup>2</sup> ; 0.38 g		
Escape velocity	4.25 km/s		
Sidereal rotation period	58.646 day; 1407.5 h		
Albedo	0.119 (bond); 0.106 (geom.)		
Surface temperature	<b>Min</b>	<b>mean</b>	<b>max</b>
0°N, 0°W	100 K	340 K	700 K
85°N, 0°W	80 K	200 K	380 K
Apparent magnitude	-2.3 to 5.7		
Angular momentum	4.5" – 13"		

### Atmosphere

Surface pressure trace

Composition: 42% Molecular oxygen, 29.0% sodium, 22.0% hydrogen, 6.0% helium, 0.5% potassium. Trace amounts of argon, nitrogen, carbon dioxide, water vapor, xenon, krypton, and neon.

We have to say a few things about the planetary surface.

Mercury's craters are very similar to the lunar ones in morphology, shape and structure. The most remarkable one is the Caloris basin, the impact that created this basin was so powerful that it also created lave eruptions and left a large concentric ring (over 2 km tall) surrounding the crater.

The impacts that generate basins are the most cataclysmic events that can affect the surface of a planet. They can cause the change of the entire planetary crust, and even internal disorders. This is what happened when the Caloris crater with a diameter of 1550 km was formed.

### The advance of Mercury's perihelion

The advance of Mercury's perihelion has been confirmed. Like any other planet, Mercury's perihelion is not fixed but has a regular motion around the Sun. For a long time it was considered that this motion is 43 arcseconds per century, which is faster by comparison with the forecasts of classical "Newtonian" celestial mechanics. This advance of the perihelion was predicted by Einstein's general theory of relativity, the cause being the space curvature due to the solar mass. This agreement between the observed advance of the perihelion and the one predicted by the general relativity was the proof in favor of the latter hypothesis's validity.

## VENUS

Venus is one of the eight planets of the Solar system and one of the four terrestrial planets in the inner system, the second distant from the Sun. It bears the name of the Roman goddess of love and beauty.

Its closeness to the Sun, structure and atmosphere density make Venus one of the warmest bodies in the solar system. It has a very weak magnetic field and no natural satellite. It is one of the only planets with a retrograde revolution motion and the only one with a rotation period greater than the revolution period.

It is the brightest body in the sky after the Sun and the Moon.

It is the second planet distant from the Sun (situated between Mercury and the Earth), at approximately 108.2 million km from the Sun. Venus' trajectory around the Sun is almost a circle: its orbit has an eccentricity of 0.0068, namely the smallest one in the Solar system.

A Venusian year is somewhat shorter than a Venusian sidereal day, in a ratio of 0.924.

Its dimension and geological structure are similar to those of the Earth. The atmosphere is extremely dense. The mixture of CO<sub>2</sub> and dense sulfur dioxide clouds create the strongest greenhouse effect in the Solar system, with temperatures of approx. 460°C. Venus' surface temperature is higher than Mercury's, although Venus is situated almost twice as far from the Sun than Mercury and receives only approx. 25% of solar radiance that Mercury does. The planet's surface has an almost uniform relief. Its magnetic field is very weak, but it drags a plasma tail 45 million km long, observed for the first time by SOHO in 1997.

Remarkable among Venus' characteristics is its retrograde rotation; it rotates around its axis very slowly, counterclockwise, while the planets of the Solar system do this often clockwise (there is another exception: Uranus). Its rotation period has been known since 1962. This rotation – slow and retrograde – produces solar days that are much shorter than the sidereal

day, sidereal days are longer on the planets with clockwise rotation<sup>2</sup>. Consequently, there are less than 2 complete solar days throughout a Venusian year.



Fig. 3: Venus

The causes of Venus’ retrograde rotation have not been determined yet. The most probable explanation would be a giant collision with another large body during the formation of the planets in the solar system. It might also be possible that the Venusian atmosphere influenced the planet’s rotation due to its great density.

Venus – the Earth’s twin sister. The analogy.

- They were born at the same time from the same gas and dust cloud, 4.6 billion years ago.
- both are planets in the inner solar system
- their surfaces have a varied ground: mountains, fields, valleys, high plateaus, volcanoes, impact craters, etc
- both have a relatively small number of craters, a sign of a relatively young surface and of a dense atmosphere
- they have close chemical compositions

Properties	Venus	Earth	Ratio Venus/Earth
Mass	4.8685×10 <sup>24</sup> kg	5.9736×10 <sup>24</sup> kg	0.815
Equatorial Radius	6,051 km	6,378 km	0.948
Mean density	5.204 g/cm <sup>3</sup>	5.515 g/cm <sup>3</sup>	0.952
Semi-major axis	108,208,930 km	149,597,887 km	0.723
Average orbital speed	35.02 km/s	29.783 km/s	1.175
Equatorial surface gravity	8.87 m/s <sup>2</sup>	9,780327 m/s <sup>2</sup>	0.906

Venus’ transit

Venus’ transit takes place when the planet passes between the Earth and the Sun, when Venus’ shadow crosses the solar disk. Due to the inclination of Venus’ orbit compared to the

<sup>2</sup> The solar day is the (average) interval between two succeeding passages of the Sun at the meridian. For instance, the Earth has a solar ( average) day of 24 h and a sidereal day of 23 h 56 min 4,09 s. On Venus the solar day has 116.75 terrestrail days (116 days 18 hours), while the sidereal day has 243.018 terrestrial days.



Earth's, this phenomenon is very rare on human time scales. It takes place twice in 8 years, this double transit being separated from the following one by more than a century (105.5 or 121.5 years)

The last transits took place on 8 June 2004 and 6 June 2012, and the following won't be until 11 December 2117.

<b>Orbital characteristics, Epoch J2000</b>	
Aphelion	108,942,109 km, 0.728231 AU
Perihelion	107,476,259 km, 0.718432 AU
Semi-major axis	108,208,930 km, 0.723332 AU
Eccentricity	0.0068
Orbital period	224.700 day, 0.615197 yr, 1.92 Venus solar day
Synodic Period	583.92 days
Average orbital speed	35.02 km/s
Inclination	3.394 71° to Ecliptic, 3.86° to Sun's equator
Longitude of ascending node	76.670 69°
Argument of perihelion	54.852 29°
Satellite	None

<b>Physical characteristics</b>	
Mean radius	6,051.8 ± 1.0 km, 0.949 9 Earths
Flattening	0
Surface area	4.60 × 10 <sup>8</sup> km <sup>2</sup> , 0.902 Earths
Volume	9.38 × 10 <sup>11</sup> km <sup>3</sup> , 0.857 Earths
Mass	4.8685 × 10 <sup>24</sup> kg, 0.815 Earths
Mean density	5.204 g/cm <sup>3</sup>
Equatorial surface gravity	8.87 m/s <sup>2</sup> , 0.904 g
Escape velocity	10.46 km/s
Sidereal rotation period	-243.018 5 day
Albedo	0.65 (geometric) or 0.75 (bond)
Surface temperature (mean)	461.85 °C
Apparent magnitude	up to -4.6 (crescent), -3.8 (full)
Angular momentum	9.7" – 66.0"

### Atmosphere

Surface pressure 93 bar (9.3 MPa)

Composition: ~96.5% Carbon dioxide, ~3.5% Nitrogen, 0.015% Sulfur dioxide, 0.007% Argon, 0.002% Water vapor, 0.001 7% Carbon monoxide, 0.001 2% Helium, 0.000 7% Neon.

### EARTH

The Earth is the third planet from the Sun in the Solar system, and the fifth in size. It belongs to the inner planets of the solar system. It is the largest terrestrial planet in the Solar system, and the only one in the Universe known to accommodate life. The Earth formed approx. 4.57 billion years ago. Its only natural satellite, the Moon, began to orbit it shortly after that, 4.533 billion years ago. By comparison, the age of the Universe is approximately 13.7 billion years. 70.8 % of the Earth's surface is covered with water, the rest of 29.2% being solid and „dry“. The zone covered with water is divided into oceans, and the land is subdivided into continents.



Fig. 4: Earth

Between the Earth and the rest of the Universe there is a permanent interaction. For example, the Moon is the cause of the tides on the Earth. The Moon also continuously influences the speed of Earth’s rotational motion. All bodies that orbit around the Earth are attracted to the Earth; this attraction force is called gravity, and the acceleration with which these bodies fall into the gravitational field is called gravitational acceleration (noted with "g" = 9.81 m/s<sup>2</sup>).

<b>Orbital characteristics, Epoch J2000</b>	
Aphelion	152,097,701 km; 1.0167103335 AU
Perihelion	147,098,074 km; 0.9832898912 AU
Semi-major axis	149,597,887.5 km; 1.0000001124 AU
Eccentricity	0.016710219
Orbital period	365.256366 days; 1.0000175 years
Average orbital speed	29.783 km/s; 107,218 km/h
Inclination	1.57869
Longitude of ascending node	348.73936°
Argument of perihelion	114.20783°
Satellite	1 (the Moon)

<b>Physical characteristics</b>	
Mean radius	6,371.0 km
Equatorial radius	6,378.1 km
Polar radius	6,356.8 k
Flattening	0.003352
Surface area	510,072,000 km <sup>2</sup>
Volume	1.0832073 × 10 <sup>12</sup> km <sup>3</sup>
Mass	5.9736 × 10 <sup>24</sup> kg
Mean density	5.515 g/cm <sup>3</sup>
Equatorial surface gravity	9.780327 m/s <sup>2</sup> [9]; 0.99732 g
Escape velocity	11.186 km/s
Sidereal rotation period	0.99726968 d; 23h 56m 4.100s
Albedo	0.367
Surface temperature (mean)	min      mean      max -89 °C    14 °C    57.7 °C

It is believed that creation of the Earth’s oceans was caused by a “shower” of comets in the Earth’s early formation period. Later impacts with asteroids added to the modification of the

environment decisively. Changes in Earth's orbit around the Sun may be one cause of ice ages on the Earth, which took place throughout history.

### **Atmosphere**

Surface pressure 101.3 kPa (MSL)

Composition: 78.08% nitrogen (N<sub>2</sub>), 20.95% oxygen (O<sub>2</sub>), 0.93% argon, 0.038% carbon dioxide; about 1% water vapor (varies with climate).

### **MARS**

Mars is the fourth distant planet from the Sun in the Solar system and the second smallest in size after Mercury. It belongs to the group of terrestrial planets. It bears the name of the Roman god of war, Mars, due to its reddish color.

Several space missions have been studying it starting from 1960 to find out as much as possible about its geography, atmosphere, as well as other details. Mars can be observed with the naked eye. It is not as bright as Venus and only seldom brighter than Jupiter. It overpasses the latter one during its most favorable configurations (oppositions).

Among all the bodies in the Solar system, the red planet has attracted the most science fiction stories. The main reason for this is often due to its famous channels, called this for the first time in 1858 by Giovanni Schiaparelli and considered to be the result of human constructions.

Mars' red color is due to iron oxide III (also called hematite), to be found in the minerals on its surface. Mars has a very strong relief; it has the highest mountain in the solar system (the volcano Olympus Mons), with a height of approx. 25 km, as well as the greatest canyon (Valles Marineris) with of an average depth of 6 km. The center of Mars is made up of an iron nucleus with a diameter of approx. 1700 km, covered with an olivine mantel and a basalt crust with an average width of 50 km.

Mars is surrounded by a thin atmosphere, consisting mainly of carbon dioxide. It used to have an active hydrosphere, and there was water on Mars once. It has two natural satellites, Phobos and Deimos, which are likely asteroids captured by the planet.

Mars' diameter is half the size of the Earth and its surface area is equal to that of the area of the continents on Earth. Mars has a mass that is about one-tenth that of Earth. Its density is the smallest among those of the terrestrial planets, which makes its gravity only somewhat smaller than of Mercury, although its mass is twice as large.

The inclination of Mars' axis is close to that of the Earth, which is why there are seasons on Mars just like on Earth. The dimensions of the polar caps vary greatly during the seasons through the exchange of carbon dioxide and water with the atmosphere.

Another common point, the Martian day is only 39 minutes longer than the terrestrial one. By contrast, due to its relative distance from the Sun, the Martian year is longer than an Earth year, more than 322 days longer than the terrestrial year.

Mars is the closest exterior planet to the Earth. This distance is smaller when Mars is in opposition, namely when it is situated opposite the Sun, as seen from the Earth. Depending on ellipticity and orbital inclination, the exact moment of closest approach to Earth may vary with a couple of days.

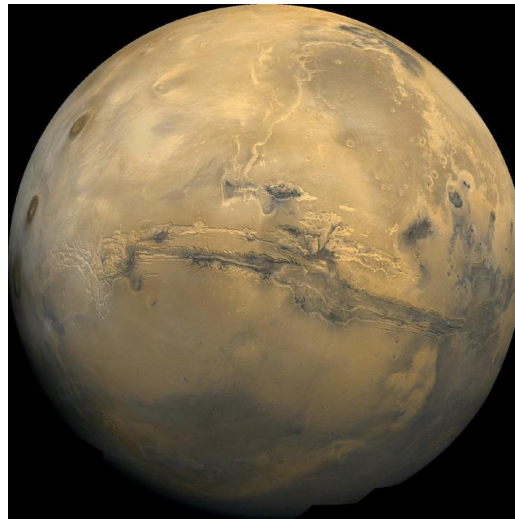

Fig. 5: Mars

On 27 August 2003 Mars was only 55,758 million km away from Earth, namely only 0.3727 AU away, the smallest distance registered in the past 59,618 years. An event such as this often results in all kinds of fantasies, for instance that Mars could be seen as big as the full Moon. However, with an apparent diameter of 25.13 arcseconds, Mars could only be seen with the naked eye as a dot, while the Moon extends over an apparent diameter of approx. 30 arcminutes. The following similar close distance between Mars and Earth will not happen again until 28 August 2287, when the distance between the two planets will be of 55,688 million km.

<b>Orbital characteristics, Epoch J2000</b>	
Aphelion	249,209,300 km; 1.665861 AU
Perihelion	206,669,000 km; 1.381497 AU
Semi-major axis	227,939,100 km; 1.523679 AU
Eccentricity	0.093315
Orbital period	686.971 day; 1.8808 Julian years
Synodic period	779.96 day; 2.135 Julian years
Average orbital speed	24.077 km/s
Inclination	1.850° to ecliptic; 5.65° to Sun's equator
Longitude of ascending node	49.562°
Argument of perihelion	286.537°
Satellite	2

<b>Physical characteristics</b>	
Equatorial radius	3,396.2 ± 0.1 km; 0.533 Earths
Polar radius	3,376.2 ± 0.1 km; 0.531 Earths
Flattening	0.00589 ± 0.00015
Surface area	144,798,500 km <sup>2</sup> ; 0.284 Earths
Volume	1.6318 × 10 <sup>11</sup> km <sup>3</sup> ; 0.151 Earths
Mass	6.4185 × 10 <sup>23</sup> kg; 0.107 Earths
Mean density	3.934 g/cm <sup>3</sup>
Equatorial surface gravity	3.69 m/s <sup>2</sup> ; 0.376 g
Escape velocity	5.027 km/s
Sidereal rotation period	1.025957 day
Albedo	0.15 (geometric) or 0.25 (bond)
Surface temperature	min      mean      max -87 °C   -46 °C   -5 °C
Apparent magnitude	+1.8 to -2.91
Angular diameter	3.5—25.1"

**Atmosphere:**

Surface pressure 0.6–1.0 kPa)

Composition 95.72% Carbon dioxide; 2.7% Nitrogen; 1.6% Argon; 0.2% Oxygen; 0.07% Carbon monoxide; 0.03% Water vapor; 0.01% Nitric oxide; 2.5 ppm Neon; 300 ppb Krypton; 130 ppb Formaldehyde; 80 ppb Xenon; 30 ppb Ozone; 10 ppb Methane.

**JUPITER**

Jupiter is the fifth distant planet from the Sun and the biggest of all the planets in our solar system. Its diameter is 11 times bigger than that of the Earth, its mass is 318 times greater than Earth, and its volume 1300 times larger than those of our planet.

- orbit: 778,547,200 km from the Sun
- diameter: 142,984 km (equatorial)
- mass:  $1.8986 \times 10^{27}$  kg

Jupiter is the fourth brightest object in the sky (after the Sun, Moon, Venus and sometimes Mars). It has been known from prehistoric times. The discovery of its four great satellites, Io, Europe, Ganymede and Callisto (known as Galilean satellites) by Galileo Galilei and Simon Marius in 1610 was the first discovery of an apparent motion center not centered on Earth. It was a major point in favor of the heliocentric theory of planetary motion of Nicolaus Copernicus. Galileo's endorsement of the Copernican motion theory brought him trouble with the Inquisition. Before the Voyager missions, only 16 of its satellites were known, it is now known to have over 60 satellites.



Fig. 6: Jupiter

**Composition:** Jupiter probably has a core of solid material that amounts up to 10 - 15 Earth masses. Above this core, is a deep layer of liquid metallic hydrogen. Due to the temperature and pressure inside Jupiter, its hydrogen is a liquid and not a gas. It is an electric conductor and the source of Jupiter's magnetic field. This layer probably contains some helium and some traces of "drifts of ice". The surface layer is mainly made up of molecular hydrogen and helium, liquid inside and gaseous outside. The atmosphere we see is only the superior part of

this deep stratum. Water, carbon dioxide, methane, as well as other simple molecules are also present in small quantities.

**Atmosphere:** Jupiter consists of approx. 86% hydrogen and 14% helium (according to the number of atoms, approx. 75/25% by mass) with traces of methane, water, ammonia and “stone”. This is very close to the original composition of the Solar Nebula, from which the entire solar system formed. Saturn has a similar composition, while Uranus and Neptune have less hydrogen and helium.

**The Great Red Spot (GRS)** was observed for the first time by the telescopes on Earth, more than 300 years ago. It is an oval of approximately 12000 by 25000 km, large enough to encompass two or three Earths. It is a region of high pressure, whose superior clouds are much higher and colder than the surrounding zones. Similar structures have been observed on Saturn and Neptune. The way in which such structures exist for such a long time has not been fully understood yet.

Jupiter and the other gaseous planets have winds of great speed in large bands at different latitudes. The winds blow in opposite directions in two adjoining bands. The small temperature or chemical composition differences are responsible for the different coloring of the bands, an aspect that dominates the image of the planet. Jupiter’s atmosphere is very turbulent. This proves that the winds are driven, to a great extent, by the internal heat of the planet and not by coming from the Sun, as is the case with the Earth.

**The Magnetosphere** Jupiter has a huge magnetic field, 14 times stronger than that of Earth’s magnetic field. Its magnetosphere extends over 650 million km (beyond Saturn’s orbit). Jupiter’s satellites are included in its magnetosphere, which partially explains the activity on Io. A possible problem for future space voyages, as well as a great problem for the designers of the probes Voyager and Galileo, is that the medium in the neighborhood of Jupiter has large quantities of particles caught by Jupiter’s magnetic field. This “radiation” is similar, but much more intense than that observed in the Van Allen belts of the Earth. It would be lethal for any unprotected human being.

The Galileo probe discovered a new intense radiation between Jupiter’s rings and the upper layer of the atmosphere. This new radiation belt has an intensity approx. 10 times higher than that of the Van Allen belts on Earth. Surprisingly, this new belt contains helium ions of high energy, of unknown origins.

**The planet’s rings** Jupiter has rings just like Saturn, but much paler and smaller. Unlike those of Saturn, Jupiter’s rings are dark. They are likely made up of small grains of rocky material. Unlike Saturn’s rings, Jupiter’s rings seem unlikely to contain ice. The particles from Jupiter’s rings likely do not remain there for long (because of the atmospheric and magnetic attraction). The Galileo probe found clear evidence that indicates that the rings are continuously supplied by the dust formed by the impacts of micrometeorites with the inner four moons.

<b>Orbital characteristics, Epoch J2000</b>	
Aphelion	816,520,800 km (5.458104 AU)
Perihelion	740,573,600 km (4.950429 AU)
Semi-major axis	778,547,200 km (5.204267 AU)
Eccentricity	0.048775
Orbital period	4,331.572 days; 11.85920 years; 10,475.8 Jupiter solar days
Synodic period	398.88 days
Average orbital speed	13.07 km/s
Mean anomaly	18.818°
Inclination	1.305° to ecliptic; 6.09° to Sun's equator
Longitude of ascending node	100.492°
Argument of perihelion	275.066°
Satellite	67

<b>Physical characteristics</b>	
Equatorial radius	71,492 ± 4 km; 11.209 Earths
Polar radius	66,854 ± 10 km; 10.517 Earths
Flattening	0.06487 ± 0.00015
Surface area	6.21796×10 <sup>10</sup> km <sup>2</sup> ; 121.9 Earths
Volume	1.43128×10 <sup>15</sup> km <sup>3</sup> ; 1321.3 Earths
Mass	1.8986×10 <sup>27</sup> kg; 317.8 Earths; 1/1047 Sun
Mean density	1.326 g/cm <sup>3</sup>
Equatorial surface gravity	24.79 m/s <sup>2</sup> ; 2.528 g
Escape velocity	59.5 km/s
Sidereal rotation period	9.925 h
Albedo	0.343 (bond); 0.52 (geom.)
Apparent magnitude	-1.6 to -2.94
Angular diameter	29.8" — 50.1"

### Atmosphere

Surface pressure 20–200 kPa[12] (cloud layer)

Scale height 27 km

**Composition:** 89.8±2.0% Hydrogen (H<sub>2</sub>), 10.2±2.0% Helium, ~0.3% Methane, ~0.026% Ammonia, ~0.003% Hydrogen deuteride (HD), 0.0006% Ethane, 0.0004% water. Ices: Ammonia, water, ammonium hydrosulfide(NH<sub>4</sub>SH).

### SATURN

Saturn is the sixth distant planet from the Sun in the Solar system. It is a gas giant planet, the second in mass and volume after Jupiter. It has a diameter approx. nine times greater than that of the Earth and is made up of mostly hydrogen. It bears the name of the Roman god Saturn

**Mass and dimensions** Saturn has the form of a flattened spheroid: it is flattened at the poles and swollen at the equator. Its equatorial and polar diameters differ approx. by 10%, as a result of its rapid rotation around its axis and of an extremely fluid internal composition. The other gas giant planets in the solar system (Jupiter, Uranus, Neptune) are also flattened, but less so.

Saturn is the second most massive planet in the Solar system, 3.3 times smaller than Jupiter, but 5.5 times bigger than Neptune and 6.5 times bigger than Uranus. It is 95 times more massive than the Earth. Its diameter is almost 9 times larger than the Earth's. Saturn is the only planet in the Solar system whose average density is smaller than that of water: 0.69

$\text{g/cm}^3$ . Although Saturn's core is denser than water, its average density is smaller than that of water because of its large hydrogen gaseous atmosphere.

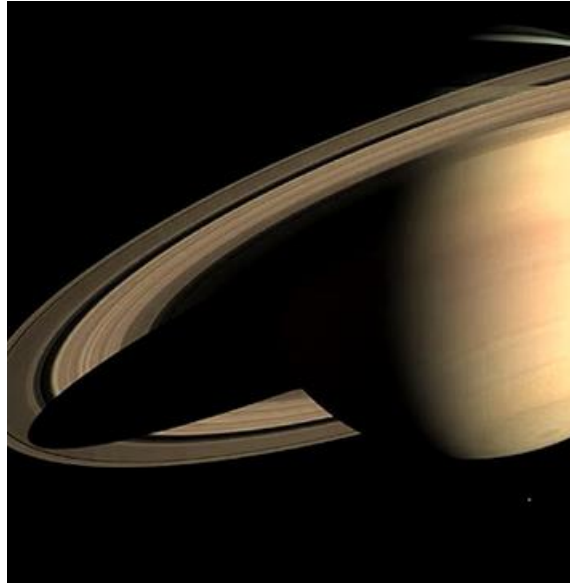

Fig. 7: Saturn

**Atmosphere:** Just like Jupiter, Saturn's atmosphere is organized in parallel bands, however these are less visible than Jupiter's and are wider near the equator. Saturn's cloud systems (as well as the long lasting storms) were first observed by the Voyager missions. The cloud observed in 1990 is an example of a great white spot, an ephemeral Saturnian phenomenon that takes place every 30 years. If periodicity remains the same, the next storm will probably take place in 2020. In 2006 NASA observed a storm of hurricane dimensions, stationed at the Southern pole of Saturn that had a well-defined eye. It is the only eye observed on another planet other than Earth. Saturn's atmosphere undergoes a differential rotation.

Saturn's rings are one of the most beautiful phenomena in the solar system, making up its defining characteristic. Unlike the other gas giant planets with rings, they are extremely bright (albedo between 0.2 and 0.6) and can also be seen with a pair of binoculars. They are dominated by permanent activity: collisions, matter accumulations, etc.

Saturn has a great number of satellites. It is difficult to say how many there are, as any piece of ice in the rings can be considered a satellite. In 2009 62 satellites were identified. 53 were confirmed and were given names. Most of them are small: 31 have diameters fewer than 10 km, while 13 are smaller than 50 km. Only seven are big enough to take on a spheroidal shape under the influence of their own gravity. Titan is the largest one, bigger than Mercury and Pluto, and the only satellite in the solar system with a dense atmosphere.

**Atmosphere:**

Scale height: 59.5 km

Composition: ~96% Hydrogen ( $\text{H}_2$ ), ~3% Helium, ~0.4% Methane, ~0.01% Ammonia, ~0.01% Hydrogen deuteride (HD), 0.000 7% Ethane, Ices: Ammonia, water, ammonium hydrosulfide ( $(\text{NH}_4\text{SH})$ )



<b>Orbital characteristics, Epoch J2000</b>	
Aphelion	1,513,325,783 km; 10.115958 AU
Perihelion	1,353,572,956 km; 9.048076 AU
Semi-major axis	1,433,449,370 km; 9.582017 AU
Eccentricity	0.055723
Orbital period	10,759.22 days; 29.4571 years
Synodic period	378.09 days
Average orbital speed	9.69 km/s
Mean anomaly	320.346 750°
Inclination	2.485 240° to ecliptic; 5.51° to Sun's equator
Longitude of ascending node	113.642 811°
Argument of perihelion	336.013 862°
Satellite	~ 200 observed (61 with secure orbits)

<b>Physical characteristics</b>	
Equatorial radius	60,268 ± 4 km; 9.4492 Earths
Polar radius	54,364 ± 10 km; 8.5521 Earths
Flattening	0.09796 ± 0.000 18
Surface area	4.27 × 10 <sup>10</sup> km <sup>2</sup> ; 83.703 Earths
Volume	8.2713 × 10 <sup>14</sup> km <sup>3</sup> ; 763.59 Earths
Mass	5.6846 × 10 <sup>26</sup> kg; 95.152 Earths
Mean density	0.687 g/cm <sup>3</sup> ; (less than water)
Equatorial surface gravity	10.44 m/s <sup>2</sup> ; 1.065 g
Escape velocity	35.5 km/s
Sidereal rotation period	10.57 hours; (10 hr 34 min)
Equatorial rotation velocity	9.87 km/s; 35 500 km/h
Axial tilt	26.73°
Albedo	0.342 (bond); 0.47 (geom.)
Apparent magnitude	+1.2 to -0.24
Angular diameter	14.5" — 20.1" (excludes rings)

## URANUS

Uranus is a gas giant planet. It is the seventh distant planet from the Sun in the solar system, the third in size and the fourth in mass. It bears the name of Chronos' father (Saturn) and of Zeus' grandfather (Jupiter). It is the first planet discovered in the modern epoch. Although it can be seen with the naked eye like the other 5 classical planets, because of its low luminosity it was not easily identified as being a planet. William Herschel announced its discovery on 13 March 1781, thus enlarging the frontiers of the Solar system for the first time in the modern epoch. Uranus is the first planet discovered by means of the telescope.

Uranus and Neptune have internal and atmospheric compositions different from those of the other great gaseous planets, Jupiter and Saturn. That is why astronomers sometimes place them in a different category, that of the frozen giants or sub-giants.

Uranus' atmosphere, although made up mainly of hydrogen and helium, also contains large quantities of water ice, ammonia and methane, as well as the usual traces of hydrocarbons. Uranus has the coldest atmosphere in the solar system, which reaches a minimum of – 224 °C. It has a complex structure of clouds: the clouds in the lower layers might be made up of water, those in the upper layers of methane.

Like the other gas giant planets, Uranus has a system of rings, a magnetosphere and numerous natural satellites. The Uranian system is unique in the Solar system because its rotation axis is tilted sideways and is almost into the plane of its revolution about the Sun. Its northern and

southern poles therefore lie where the other planets have their equator. In 1986, Voyager 2 took images of Uranus that show a planet almost featureless in visible light, without cloud bands or storms as on the other gaseous planets. However, recent observations have shown signs of seasonal change and an increase of the meteorological activity, in a period when Uranus approached its equinox of December 2007. The wind on Uranus can attain speeds of 250 m/s on its surface.

**Orbit and rotation** Uranus' revolution period around the Sun is 84 terrestrial years. Its average distance from the Sun is of approx. 3 billion km. The solar flux intensity on Uranus is of approx. 1/400 of that received on Earth.

The rotation period of Uranus' interior is 17 hours and 14 minutes. In the upper atmosphere violent winds take place in the rotation direction, as is the case with all the giant gaseous planets. Consequently, around 60° latitude, visible parts of the atmosphere travel faster and make a complete rotation in less than 14 hours.

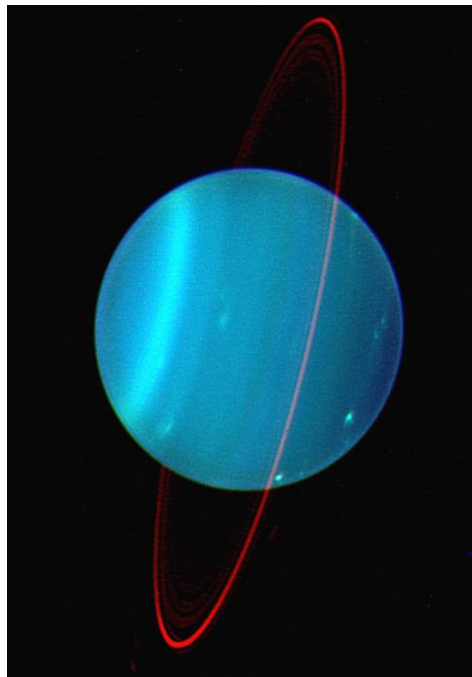

Fig. 8 Uranus

Uranus is a giant planet, like Jupiter, Saturn and Neptune. Even if we know very few things about its internal composition, we do know that it is certainly different from that of Jupiter or Saturn. Models of the internal structure of Uranus show that it should have a solid nucleus of iron silicates, with a diameter of approx. 7500 km, surrounded by a mantle made up of water ice mixed with helium, methane and ammonia that is 10,000 km wide, followed by a superficial atmosphere of hydrogen and liquid helium, of approx. 7600 km. Unlike Jupiter and Saturn, Uranus is not massive enough to preserve hydrogen in a metallic state around its nucleus.

The bluish-green color is due to the presence of methane in the atmosphere, which absorbs especially in the red and the infrared.

Uranus has at least 13 main rings.

Unlike any other planet in the solar system, Uranus is very inclined against its axis, as the latter one is almost parallel to its orbital plane. We might say that it rolls on its orbit and exposes to the Sun its north pole and its southern pole successively.

One consequence of this orientation is that the polar regions receive more energy from the Sun than the equatorial ones. Nevertheless, Uranus remains warmer at the equator than at the poles, a mechanism still unexplained. Any theory for the formation of Uranus that also accounts for its inclination, usually incorporates the idea of a cataclysmic collision with another body before its present formation.

Uranus has at least 27 natural satellites. The first two were discovered by William Herschel on 13 March 1787 and were called Titania and Oberon.

Orbital characteristics, Epoch J2000	
Aphelion	3,004,419,704 km, 20.083305 AU
Perihelion	2,748,938,461 km, 18.375518 AU
Semi-major axis	2,876,679,082 km, 19.229411 AU
Eccentricity	0.044405
Orbital period	30,799.095 days, 84.3233 years
Synodic period	369.66 day
Average orbital speed	6.81 km/s
Mean anomaly	142.955 717°
Inclination	0.772 556° to ecliptic, 6.48° to Sun's equator
Longitude of ascending node	73.989 821°
Argument of perihelion	96.541 318°
Satellite	27

Physical characteristics	
Equatorial radius	25,559 ± 4 km, 4.007 Earths
Polar radius	24,973 ± 20 km, 3.929 Earths
Flattening	0.0229 ± 0.0008
Surface area	8.1156 × 10 <sup>9</sup> km <sup>2</sup> , 15.91 Earths
Volume	6.833 × 10 <sup>13</sup> km <sup>3</sup> , 63.086 Earths
Mass	(8.6810 ± 0.0013) × 10 <sup>25</sup> kg, 14.536 Earths
Mean density	1.27 g/cm <sup>3</sup>
Equatorial surface gravity	8.69 m/s <sup>2</sup> , 0.886 g
Escape velocity	21.3 km/s
Sidereal rotation period	−0.718 33 day, 7 h 14 min 24
Equatorial rotation velocity	2.59 km/s, 9,320 km/h
Axial tilt	97.77°
Albedo	0.300 (bond), 0.51 (geom.)
Apparent magnitude	5.9 to 5.32
Angular diameter	3.3"–4.1"

### Atmosphere

Composition (*below 1.3 bar*): 83 ± 3% Hydrogen (H<sub>2</sub>), 15 ± 3% Helium, 2.3% Methane, 0.009% (0.007–0.015%) Hydrogen deuteride (HD). Ices: Ammonia, water, ammonium hydrosulfide (NH<sub>4</sub>SH), methane (CH<sub>4</sub>).

### NEPTUNE

Neptune is the eighth and the farthest planet from the Sun in the Solar system. It is also the last gaseous giant planet. It was discovered by the German astronomer Johann Gottfried Galle on 23 September 1847, following the predictions of Urban Le Verrier who, like the English

astronomer John Couch Adams, had found through mathematical calculations the region in the sky where it could likely be found.

It bears the name of the Roman god of the seas, Neptune. Neptune is not visible with the naked eye and does not appear as a bluish-green disk through the telescope. It was visited only once by a space probe, Voyager 2, who passed by it on 25 August 1989. Its largest satellite is Triton.

Its internal composition is similar to that of Uranus. It is believed that it has a solid nucleus made of silicates and iron, almost as big as the mass of the Earth. Its nucleus, just like Uranus', is supposedly covered with a rather uniform composition (rocks in fusion, ice, 15% hydrogen and a few helium); it does not have any structure in "layers" like Jupiter and Saturn.

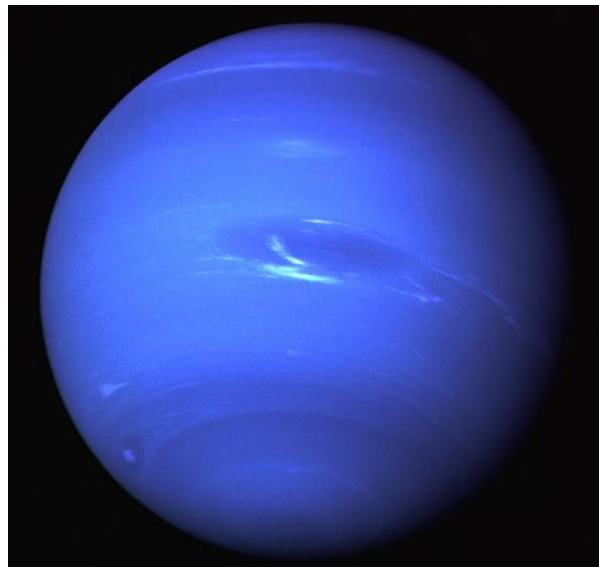

Fig. 10: Neptune

Its bluish color comes mainly from methane, which absorbs light in the wavelengths of red. It seems that another composition give Neptune its bluish color, but that has not been defined yet.

Like the other giant gaseous planets, it has an aeolian system made up of very rapid winds in bands parallel to the equator, of immense storms and vortexes. The fastest winds on Neptune blew at speeds over 2,000 km/h. During the survey of Voyager 2, the most interesting formation discovered was the "Dark Great Spot", which was about the size of the "Red Great Spot" on Jupiter. This spot was not observed about 5 years later when the Hubble Space Telescope took observations of Uranus. The winds on Uranus might have speeds as high as 300 m/s (1080 km/h) or even up to 2500 km/h. This spot might be a dark giant hurricane that supposedly travels at 1000 km/h.

Neptune has fewer visible planetary rings. They are dark and their origin is yet unknown. Neptune has at least 14 natural satellites, among them the largest is Triton, discovered by William Lassell only 17 days after the discovery of Neptune.

<b>Orbital characteristics, Epoch J2000</b>	
Aphelion	4,553,946,490 km, 30.44125206 AU
Perihelion	4,452,940,833 km, 29.76607095 AU
Semi-major axis	4,503,443,661 km, 30.10366151 AU
Eccentricity	0.011214269
Orbital period	60,190 days, 164.79 years
Synodic period	367.49 day
Average orbital speed	5.43 km/
Mean anomaly	267.767281°
Inclination	1.767975° to ecliptic, 6.43° to Sun's equator
Longitude of ascending node	131.794310°
Argument of perihelion	265.646853°
Satellite	14

<b>Physical characteristics</b>	
Equatorial radius	24,764 ± 15 km, 3.883 Earths
Polar radius	24,341 ± 30 km, 3.829 Earths
Flattening	0.0171 ± 0.0013
Surface area	7.6408 × 10 <sup>9</sup> km <sup>2</sup> , 14.98 Earths
Volume	6.254 × 10 <sup>13</sup> km <sup>3</sup> , 57.74 Earths
Mass	1.0243 × 10 <sup>26</sup> kg, 17.147 Earths
Mean density	1.638 g/cm <sup>3</sup>
Equatorial surface gravity	11.15 m/s <sup>2</sup> , 1.14 g
Escape velocity	23.5 km/s
Sidereal rotation period	0.6713 day, 16 h 6 min 36 s
Equatorial rotation velocity	2.68 km/s, 9,660 km/h
Axial tilt	28.32°
Albedo	0.290 (bond), 0.41 (geom.)[7]
Apparent magnitude	8.0 to 7.78
Angular diameter	2.2"-2.4

**Atmosphere:**

Composition: 80±3.2% Hydrogen (H<sub>2</sub>), 19±3.2% Helium, 1.5±0.5% Methane, ~0.019% Hydrogen deuteride (HD), ~0.00015 Ethane. Ices: Ammonia, water, (NH<sub>4</sub>SH), Methane

## Other Bodies in the Solar System

### The interplanetary environment

Besides light, the Sun radiates a continuous flux of charged particles (plasma) called solar wind. This flux dissipates at a speed of 1.5 millions km/h, thus creating the heliosphere, a thin atmosphere which surrounds the Solar system out to a distance of approx. 100 AU (marking the heliopause). The matter that makes up the heliosphere is called interplanetary medium. The solar cycle of 11 years, as well as the frequent solar flares and coronal mass ejections, disturb the heliosphere and create a space climate. The rotation of the solar magnetic field acts upon the interplanetary medium, creating the stratum of heliospheric current, which is the greatest structure of the Solar system.

The terrestrial magnetic field protects the atmosphere from the solar wind. The interaction between the solar wind and the terrestrial magnetic field brings about the polar aurora.

The heliosphere ensures a partial protection of the Solar system from cosmic rays, that is higher on the planets with a magnetic field.

The interplanetary medium accommodates at least two regions of cosmic dust under the form of a disk. The first one, the cloud of zodiacal dust, is in the internal Solar system and produces the zodiacal light. It probably formed through a collision inside the asteroid belt caused by the interactions with the planets. The second one extends between 10 and 40 AU and was probably created during similar collisions in the Kuiper belt.

### THE BELT OF ASTEROIDS

Asteroids are mainly small bodies in the solar system made up of rocks and non-volatile metallic minerals. The asteroid belt occupies an orbit located between Mars and Jupiter, at a distance of 2.3 up to 3.3 AU from the Sun. The asteroid belt formed from the primordial solar nebula as a group of planetesimals, the smaller precursors of planets. These planetesimals were too strongly perturbed by Jupiter's gravity to form a planet.

Asteroids range between several hundred kilometers down to microscopic dust. All, except the greatest one, Ceres, are considered small bodies. A few of the other large asteroids such as Vesta and Hygeia are also still considered small bodies, they could be classified as dwarf planets at some point, if in the future it can be determined that they have reached hydrostatic equilibrium.

The asteroid belt contains thousands, even millions of bodies with a diameter of over one kilometer. Nevertheless, the total mass of the belt is only 4% of the Moon's mass.

Ceres (2.77 AU) is the largest body in the asteroid belt and the only dwarf planet (classified thus in 2006). With a diameter of almost 1000 km, and enough mass that it is in hydrostatic equilibrium and has a spherical shape.

### COMETS

Comets are small bodies in the Solar system, with diameters on the order of kilometers, comets are generally made up of volatile ices. They have very eccentric orbits, with the perihelion sometimes situated in the inner Solar system, while the aphelion is beyond Pluto. When a comet enters the inner Solar system, its close approach to the Sun leads to the sublimation and ionization of its surface, creating a tail: a long trail made up of gas and dust.



Fig. 11: Comet

Short period comets (e.g. Halley Comet) complete their orbits in less than 200 years and seem to originate in the Kuiper belt. Long period comets (e.g. Hale-Bopp comet) have a periodicity of several thousands years and seem to originate in Oort's cloud. Finally, there are some comets that have a hyperbolic trajectory, suggesting they may eventually escape the Solar system. Old comets have lost the greatest part of their volatile components and today are often considered asteroids.

**Centauri**, situated between 9 and 30 AU, are icy bodies analogous to the comets, that orbit between Jupiter and Neptune. The greatest centaur known, Chariklo, has a diameter ranging between 200 and 250 km. The first centaur discovered, Chiron, was considered in the beginning to be a comet because it developed a cometary tail. Some astronomers classify centaurs as bodies of Kuiper belt.

The **Kuiper belt** is a great ring made up of debris belonging to a large debris ring, similar to the asteroid belt, but made up mainly of ice. The first part of the Kuiper belt extends between 30 and 50 AU from the Sun and stops at "Kuiper's cliff", from there begins the second part of the belt out to 100 AU. This region is believed to be the source of short period comets.

It is mainly made up of small bodies, as well as of some rather big ones, like Quaoar, Varuna or Orcus, which might be classified as dwarf planets.

The Kuiper belt can be divided largely into "classical" objects and objects in resonance with Neptune. An example to this effect would be the plutinos that complete two orbits for every three that Neptune has completed.

## PLUTO and CHARON

**Pluto** (39 AU on average), a dwarf planet, is the largest known body of the Kuiper belt. Discovered in 1930, it was considered a planet and re-classified in August 2006. Pluto has an eccentric orbit inclined by  $17^\circ$  to its ecliptic plane. Pluto's orbital distance extends up to 29.7 AU at the perihelion and 49.5 AU at the aphelion.

**Pluto's largest satellite**, Charon, is massive enough so that the two orbit around each other, around a common center of mass that is situated above the surface of each of the bodies. Four other small satellites, (Nix, Styx, Kerberos and Hydra), orbit the Pluto. Pluto is in an orbital resonance of 3:2 with Neptune (the planet orbits the Sun twice, for every three times Neptune orbits the Sun). The other bodies of the Kuiper belt that participate in this resonance with Neptune are called plutinos (namely small Plutos).

## Bibliography

- Collin, S, Stavinschi, M., Leçons d'astronomie, Ed. Ars Docendi, 2003.
- Kovalevsky, J, Modern Astrometry, Springer Verlag, 2002.
- Nato A., Advances in Solar Research at eclipses, from ground and from space, eds. J.P. Zahn, M. Stavinschi, Series C: Mathematical and Physical Sciences, vol. 558, Kluwer Publishing House, 2000.
- Nato A, Theoretical and Observational Problems Related to Solar Eclipses, eds. Z. Mouradian, M. Stavinschi, Kluwer, 1997.

# Local Horizon and Sundials

**Rosa M. Ros**

International Astronomical Union, Technical University of Catalonia (Barcelona, Spain)

## Summary

The study of the horizon is crucial to facilitate the students' first observations in an educational center. A simple model that has to be made in each center allows us to study and comprehend the first astronomical rudiments easier. The model is also presented as a simple model of an equatorial clock and from it, we can make other models (horizontal and vertical).

## Goals

- Understand the diurnal and annual movement of the Sun.
- Understand the celestial vault movement.
- Understand the construction of an elemental Sun watch.

## The Earth rotates and revolves

As it is well known, Earth rotates around its axis, which results in day and night. The rotation axis is what ancient astronomers called the axis of the Earth as it seemed that the sky moved around this axis (the daytime sky and the night sky). But Earth revolves in an ellipse, with the Sun in one of its focus. As first approximation, we can suppose that it is a circular motion (as the ellipse's eccentricity is almost zero, i.e. the orbit is almost a circle).

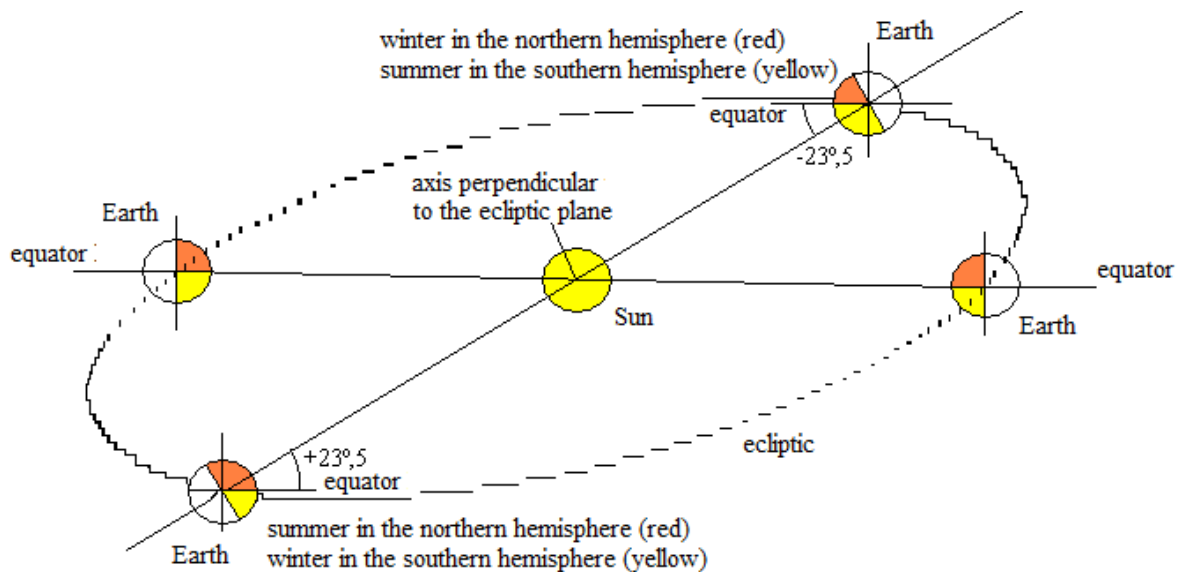

Fig. 1: Scheme of Earth's revolution. The angle between the terrestrial equator and the ecliptic plane is 23.5°. The angle between the rotational terrestrial axis and the axis perpendicular to the ecliptic plane is also 23.5°.



Earth needs a year to make a full orbit around the Sun, but it does so in a plane, the ecliptic plane, which is not perpendicular to the rotational terrestrial axis; it is inclined. Specifically, the angle between the rotational terrestrial axis and the axis perpendicular to the ecliptic is  $23.5^\circ$ . Similarly, the angle between the terrestrial equator plane and the ecliptic plane is  $23.5^\circ$  (figure 1). This inclination causes the seasons. To visualize this phenomenon we are going to build a little model (figure 2).

We illustrate this effect with four spheres and a light bulb, representing the Sun, to be placed in the center. It is good to draw the terrestrial surface to distinguish the equator and the poles. Then, we give some values of distances relative to the sphere's size that represents the Earth models. In our case, we use 8 cm diameter models. We will get a little square tablecloth or paper that is about 25 cm across the diagonal. We situate the four spheres in a cross shape (each one in front of the other, figure 2) elevated using 4 sticks of 3, 15, 25 and 15 cm of height respectively. The values are calculated so that the inclination of the plane of the equator with respect the ecliptic plane is about  $23^\circ$ .



Fig. 2a, 2b and 2c: Distribution of the four spheres representing Earth and the light bulb representing the Sun, in the middle. It is necessary to distribute the relative positions so that the angle of the line from the center of the Sun to the center of the Earth is  $23^\circ$  with respect the ground that represents the equatorial plane.

We will situate the model in a dark room and turn on the light bulb (it could be a candle, but always be aware that the relative heights are important). It is obvious that the sphere at position A receives more light in the northern hemisphere than the one at the position C (figure 3), while the illuminated area of the southern hemisphere is greater in C than in A. At positions B and D, both hemispheres are equally illuminated; these correspond to spring and autumnal equinoxes. At the times when there is more illuminated area we say that it is summer and when there is less, it is winter. We deduce that when the Earth is at position A, it is summer in the northern hemisphere and winter in the southern hemisphere.

When the Earth is at position C, it is winter in the northern hemisphere and summer in the southern hemisphere.



Fig. 3: Model of the revolution motion that explains seasons. When the Earth is at position A it is summer in the northern hemisphere and winter in the southern hemisphere. When the Earth is at position C it is winter in the northern hemisphere and summer in the southern hemisphere. And when the Earth is at positions B and D hemispheres are equally illuminated and equinoxes take place. Then, daytime and nighttime are equal.

This model offers many opportunities for study because if we imagine that a person lives in one of the hemispheres, we will see that he/she sees the Sun in different heights depending on the season. We imagine, for example, that we have a person in the northern hemisphere when we are at position A, this person sees the Sun above the equatorial plane  $23.5^\circ$  (figure 4a). However, if he/she is in the northern hemisphere but in the position C, he/she sees the Sun below the equator at  $-23.5^\circ$  (figure 4b). When he/she is at positions B and D, he/she sees it exactly on the equator, i.e.  $0^\circ$  above the equator. It is not easy to imagine how this model would work, so we are going to build a more realistic model, where the observer is tied to Earth and has no option to see the scheme from the exterior of the terrestrial orbit. We will build a model relative to the local horizon of the observer, AN OBSERVATIONAL MODEL.

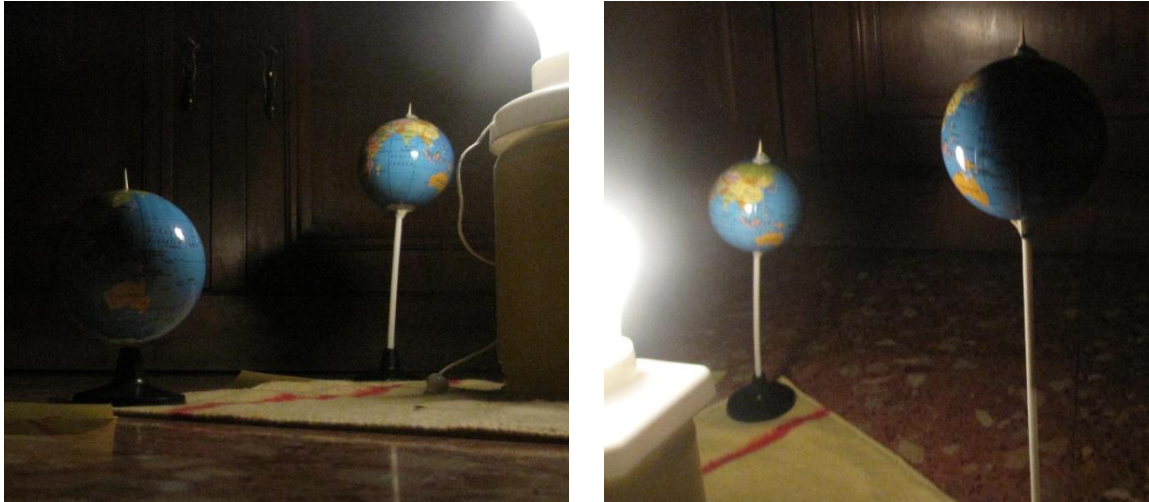

Fig. 4a: At the position A it is summer in the northern hemisphere and the Sun is  $23.5^\circ$  above equator. However, in the southern hemisphere it is winter, Fig. 4b: At the position C it is winter in the northern hemisphere and the Sun is  $23.5$  below the equator. However, in the southern hemisphere it is summer

## Observation

Teachers from different science fields (mechanics, electricity, chemistry, biology, etc.) tend to say that it is not possible to work correctly in a secondary science center without a laboratory. In this sense, astronomy teachers tend to be happy because they always have an astronomical laboratory. All institutes and schools have a place where students play: the outdoor playground or yard. But these are not only playtime places, they are also astronomical laboratories: a place where it is possible to carry out practical astronomical activities. If we have a laboratory in every school or institute, it seems opportune to use it!



Fig. 5: Classical representation of the celestial sphere.

A problem that appears when a student uses the school-yard to do practical astronomical activities is the lack of connection with the teacher's explanations of the celestial sphere inside the classroom and outside.

When the teacher talks about meridians and parallels or position coordinates on the blackboard, in texts, or in models, he/she presents figures like figure 5. This is not very difficult and students tend to understand it without a problem. Figures that students have before their eyes are analogues to the ones that they have used when were studying geography (figure 6).

Problems begin when we are viewing the sky and there is no line. It is impossible to see the rotation axis, and it is not really easy to find references in the sky. Now the principal problem is that a student is inside the celestial sphere while in classroom, but we have presented all the information viewing the sky from the exterior of the celestial sphere. Then, it is not simple to understand the new situation of being inside the sphere (figure 7).

Obviously, after this experience we could think how to change our presentation in the classroom. It is possible to do the presentation from the internal point of view of the sphere. This way is much more similar to the real situation of the observer, but it is not interesting to offer only this presentation. Students have to be able to read any astronomy book and understand the correspondent abstraction of the celestial sphere observation from the exterior, a normal situation in the scientific literature. In these circumstances, it is possible to think about making a model for the students that allows the comparison of both points of view and that also “makes the sky lines visible” and provides a better comprehension of the horizon.

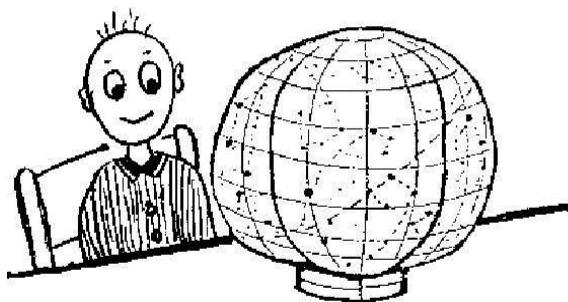

Fig. 6: Celestial sphere from the exterior.

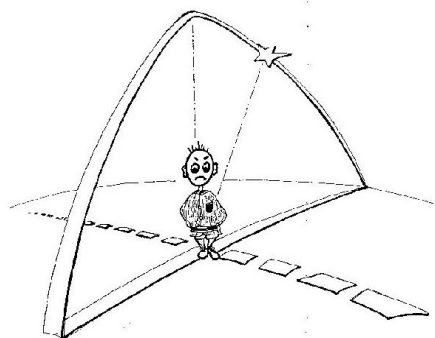

Fig. 7: Celestial sphere from the interior.

## Local model of the horizon

We begin by taking a photograph of the horizon. It is very easy to take some photographs of the horizon with a camera and a tripod from any place of the school yard – if local buildings allow us to do it – or from any balcony with a clearer view of the horizon. (We will mark the tripod position with paint or chalk on the ground). It is very important to select a good place, because the idea is to situate the model there during every observation. When taking the photo, it is necessary that it has a common area with the next one, and then we can join all the photographs in order to get the horizon as a chain of photographs continuously.

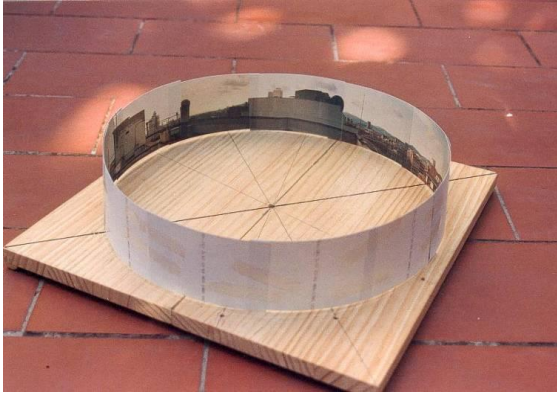

Fig. 8: The local horizon.

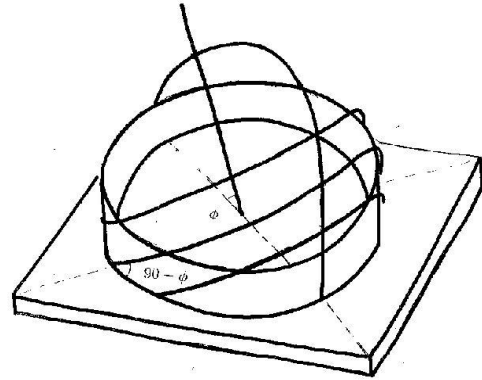

Fig. 9: Model showing the horizon and polar axis.

When we have all the photos, we can connect them. Place one copy next to another in a continuous way, and then make a cylinder that will be fixed in a wood square base in the same place that we took the photos (figure 9). It is very important to situate all photos according to the real horizon.

Later, we introduce the terrestrial rotation axis. Taking the latitudinal value of the place, we can introduce a wire with the corresponding inclination (latitude) on the model (figure 9).

With this value, it is possible to fix the rotational axis of the model. As the model is oriented according to the local horizon, the elongation of the wire is used to see the real axis, to locate the South Pole, and also to imagine the position of the cardinal point south (figure 10). Obviously, to introduce the cardinal point north and the North Pole results easily. Later, we can draw the North-South straight line in the model and also in the court or balcony ground where we took the pictures (using the normal process to determinate the north-south straight line). This is very important because every time we use this model, we will have to orient it, and it is very useful to have this real north-south straight line to facilitate the work. (We can verify this direction with a compass).

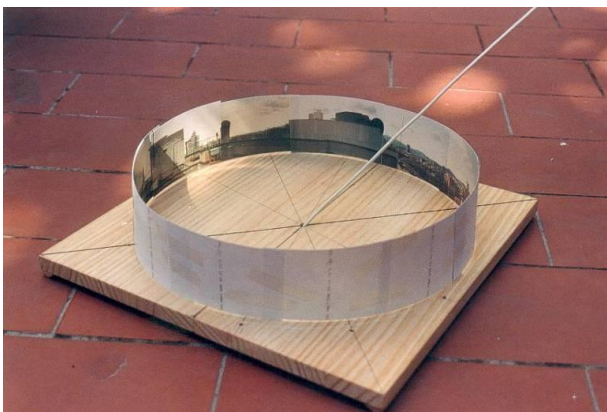

Fig. 10: Model with horizon ring and polar axis.

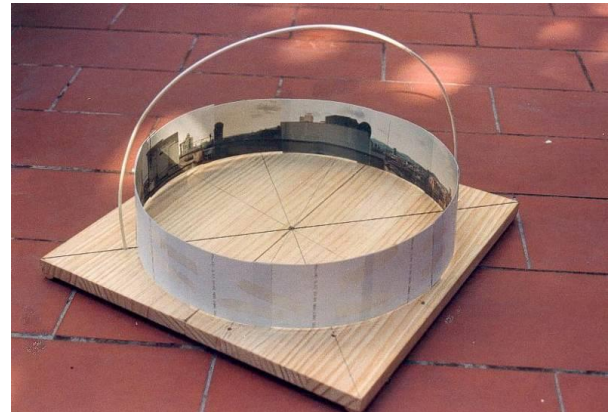

Fig. 11: Model with the local meridian.

The next step consists of locating the meridian of the place. The local meridian is very easy to define, but it is not a simple concept to assimilate for the students (maybe because everyone has his own meridian). We can fix a wire that passes for the cardinal points north and south and the rotation axis of Earth (figure 11). This wire is the meridian visualization of the location of the model, but allows us to imagine the local meridian line in the sky. Now it is very easy to imagine because it begins in the same places that student sees in the model. The local meridian begins in the same building as it does in the photo but on the real horizon. When the meridian passes above his head, it will end in the same building that we see, thanks to the wire in the horizon of the photos.

The process to introduce the equator is more complicated. One possibility consists of the east-west line. This solution is very simple, but it does not reach anything from the pedagogic point of view. For educational purposes, it is more convenient to use photography again. We can situate the camera on the tripod again in the same position that it was in when we took the first photos of the horizon. (This is why we painted the corresponding marks on the ground, so we could situate the tripod in the same place again).

With the camera on the tripod, we take a photo of the sunrise and the sunset on the first day of spring and autumn. In this case, we will have two photos of the precise position of east and west cardinal points respectively, with respect to the horizon in the photos and obviously above the real horizon.

We simulate the equator with a wire perpendicular to the terrestrial rotation axis; it is fastened at the east and west cardinal points (in the horizontal plane that is perpendicular to the north-south line). However, it is not easy to fix this wire to the wire that symbolizes the rotation axis because it is inclined, and obviously it is inclined to the equator also. This leaves the question as to what inclination to use.

We will take four or five pictures of the sunrise on the first day of spring or summer. Photographing the sun is dangerous when it is quite high in the sky, but it is safe during sunrise or sunset when the Earth's atmosphere acts like a filter. We will use all the photographs and use the appropriate software on put them together (using some reference to the horizon), and we can distinguish the inclination of the sun itself on the horizon. This picture will serve to introduce the proper slope on the wire representing the equator in the model (figure 13).

Using the two photographs of the cardinal points East and West, it is possible to know the inclination of the traces of the stars in equator, and therefore it is possible to locate the wire that symbolizes equator smoothly. We now know the fixed points and also the inclination, so the wire can be fastened on the frame and also hold the local meridian (figure 13).

If we consider the Sun as a normal star (the Sun is the most important star for us because it is the nearest, but its behavior is not very different from other stars), we can obtain the inclined motion of stars when they rise or set with respect to the horizon. To do this we only have to take two pictures of this instant near the cardinal point east and west (figure 14).

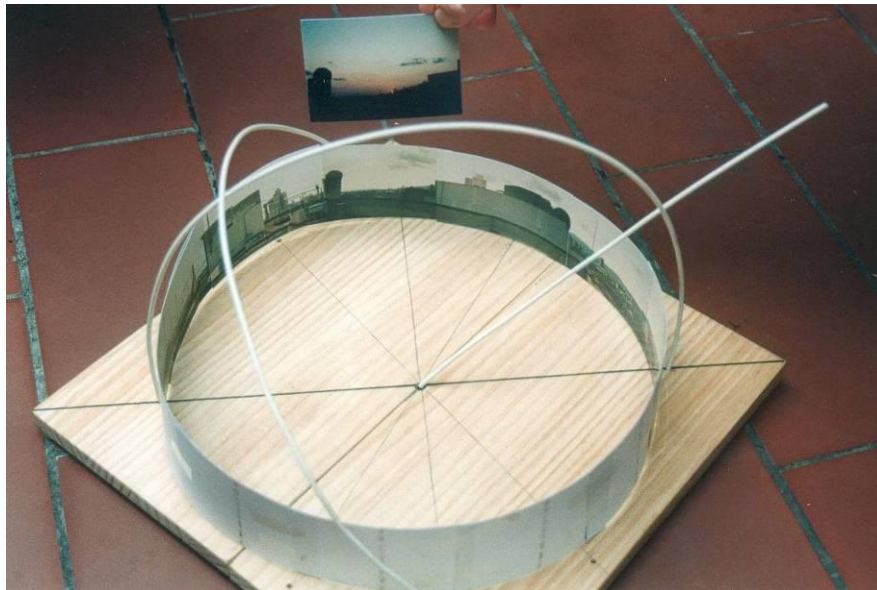

Fig. 12: Sunset point the day of the spring or autumn equinox.

It may be impossible to take the pictures mentioned in the previous paragraph from the city where the school is built. We have to go to the countryside, in a place that is not affected by light pollution, and take pictures with a single-lens reflex camera on a tripod with a cable release. About 10 minutes of exposure is enough. It is very important to place the camera parallel to horizon (we can use a level to do this operation).

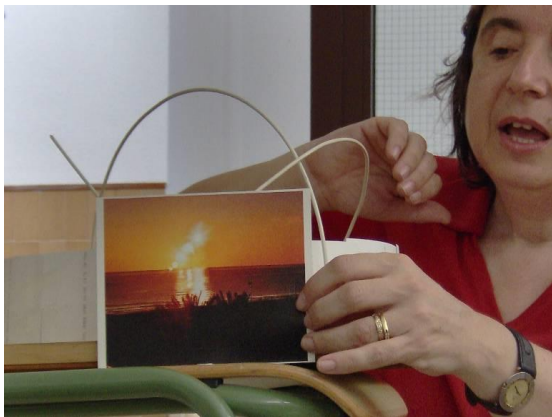

Fig. 13: Trace of the sunrise.

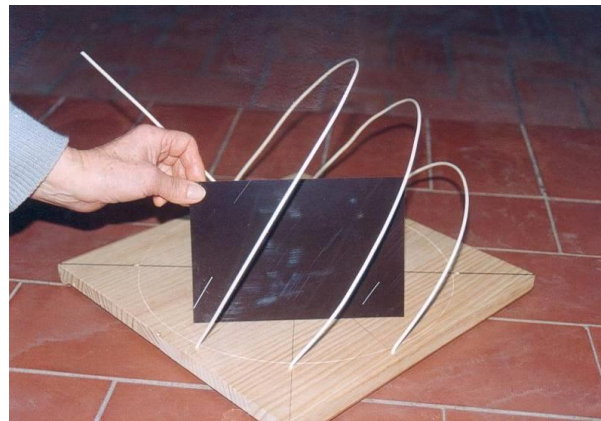

Fig. 14: Traces of the stars in the east.

Take this opportunity to get a small portfolio of photographs. For example, you can take one of the pole area giving a 15 minute exposure, another one of the area above it along the local meridian, another one following the same meridian and so forth, until you get to the picture that is on the horizon. The idea is to photograph all the local meridian from north to south, passing over our heads. Obviously, the local meridian of the place where we have decided to take pictures is not the same as that of the school, but students can easily understand this small difference.

When we have all the pictures, we can build a meridian strip with them all. With this strip, students can better understand the movement of the celestial sphere around Earth's axis of rotation. Interestingly, with the same exposure time, the trajectories drawn by stars change their length. It is at a minimum around the pole and maximum at the equator. It also changes shape. At the equator, the trajectory draws a straight line. In the area near the pole, lines are concave curves above the equator and are convex below. If we make paper copies of the pictures large enough, we can put the strip over the head of the students, allowing them to visualize and understand the movement better.

Using the two photographs of east and west cardinal points, it is possible to know the inclination of the traces of stars at the equator, and therefore it is possible to locate the wire that symbolizes the equator without problems. We know the points where we have to fix it and also the inclination, so the wire can be attached to the wood and to the local meridian (figure 8).

It is clearly possible to introduce the strip of pictures of the local meridian on the model. It is sufficient to make some copies and make a hole in them at the point that indicates the pole, in order to introduce the axis of rotation. Note that the wire of the equator corresponds to the straight-line traces that are on the tape (figure 15).

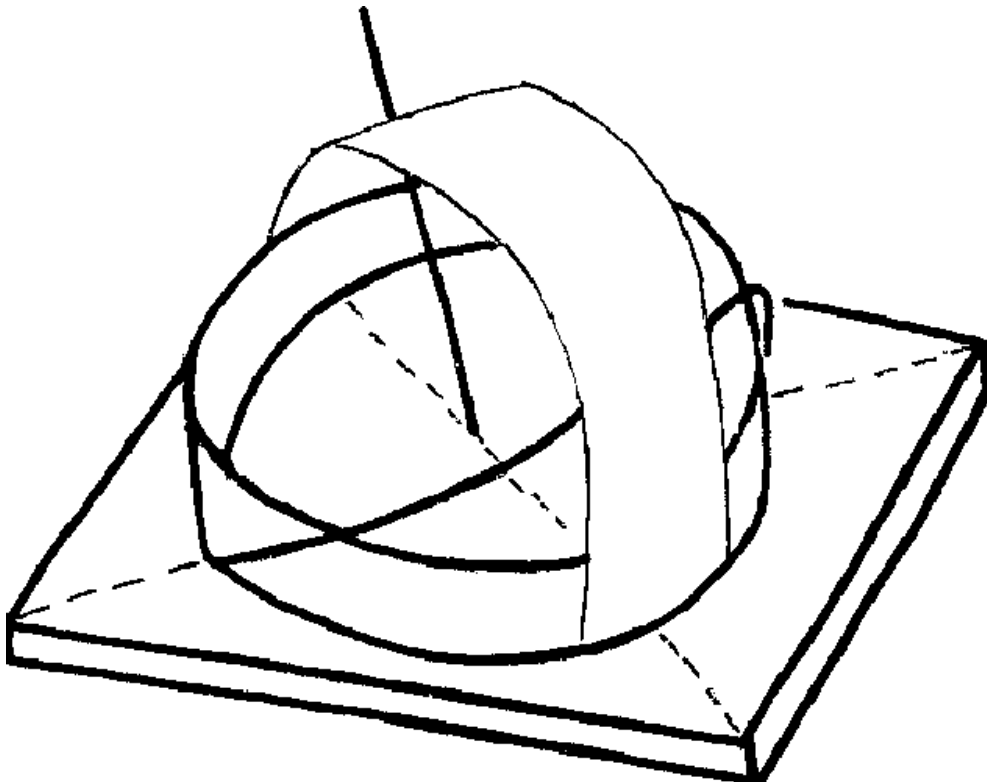

Fig. 15: The local meridian pictures.

With this model, we can offer the students the two possibilities of viewing the celestial sphere from the inside and from the outside.



If we again take two pictures of the first day of winter and summer when the Sun rises and sets, students will be able to see that the locations are very different in their city. The difference between them is amazing. You can also set the parallels of Cancer and Capricorn with the pictures that give the slope of the equator, since the parallels follow this same inclination. With a simple conveyor, it is possible to verify that the internal angle between the Tropic of Cancer and the equator is about  $23^\circ$ , and this is also the angle formed between the equator and the Tropic of Capricorn (figures 16 and 17).

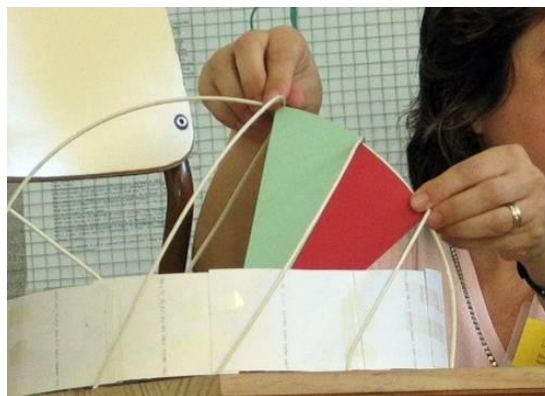
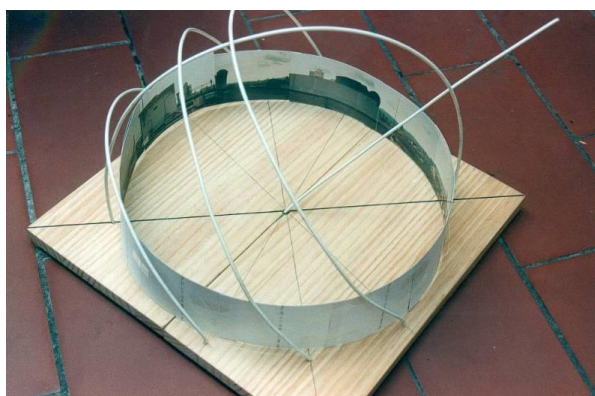

Fig. 16: Sun trajectories the first day of each season. Sunset and sunrise points do not coincide except two days: Equinox days. Fig. 17: The angle between two trajectories of the first day of two consecutive seasons is  $23.5^\circ$

For training students, it is interesting for them to see that sunrises and sunsets do not always coincide with the east and west, respectively. There are many books that mention that the Sun rises in the east and sets in the west. Students can see that this is true only twice a year, and it is not true on the remaining days (figures 16 and 17).

Thus, students see in a practical and simultaneous way the sphere from the inside (the real sphere) and from the outside (the model). With such model, students can understand their environment better, and questions about it can be resolved easily. They can also display the area that corresponds the motion of the sun (between the parallels of the model) and imagine it above the sky and real horizon of the city. The orientation becomes piece of cake.

## Sundials

There are other possible applications of the model. This model is no more than a large sundial. It is great for explaining the construction of a clock in a simple and didactic way, considering only the horizon and the motion of the Sun. Firstly; it is very easy to see that the Earth's axis of rotation becomes the stylus of the clock.

If we introduce a plane in the direction of the equatorial plane and move a flashlight on the Tropic of Cancer, we can see the shadow of the stylus (the wire that represents the Earth's rotation axis) crossing the plane of the equatorial quadrant. On the other hand, when we move the flashlight on the Tropic of Capricorn, the shadow appears in the area below the plane, and it is clear that when the flashlight is placed on the equator, no shadow occurs. Thus, it is easy

to verify that the equatorial clock works in summer and spring, showing hours on the clock's plane, in winter and autumn showing hours below it, and that two days per year, on the two equinoxes days, it does not work.

Considering the equatorial plane, the horizontal and vertical (oriented east-west), we can see that the flashlight indicates the same hours in the three quadrants (figure 18). In addition, we can see when the morning and afternoon hours are for the same stylus (the Earth's rotation axis). Obviously, it's the same time in the three clocks. It is easily verified in which area we have to draw the morning and afternoon hours for each clock. (All teachers have at some point received badly drawn hours on a sundial, but using this model this no longer happens).

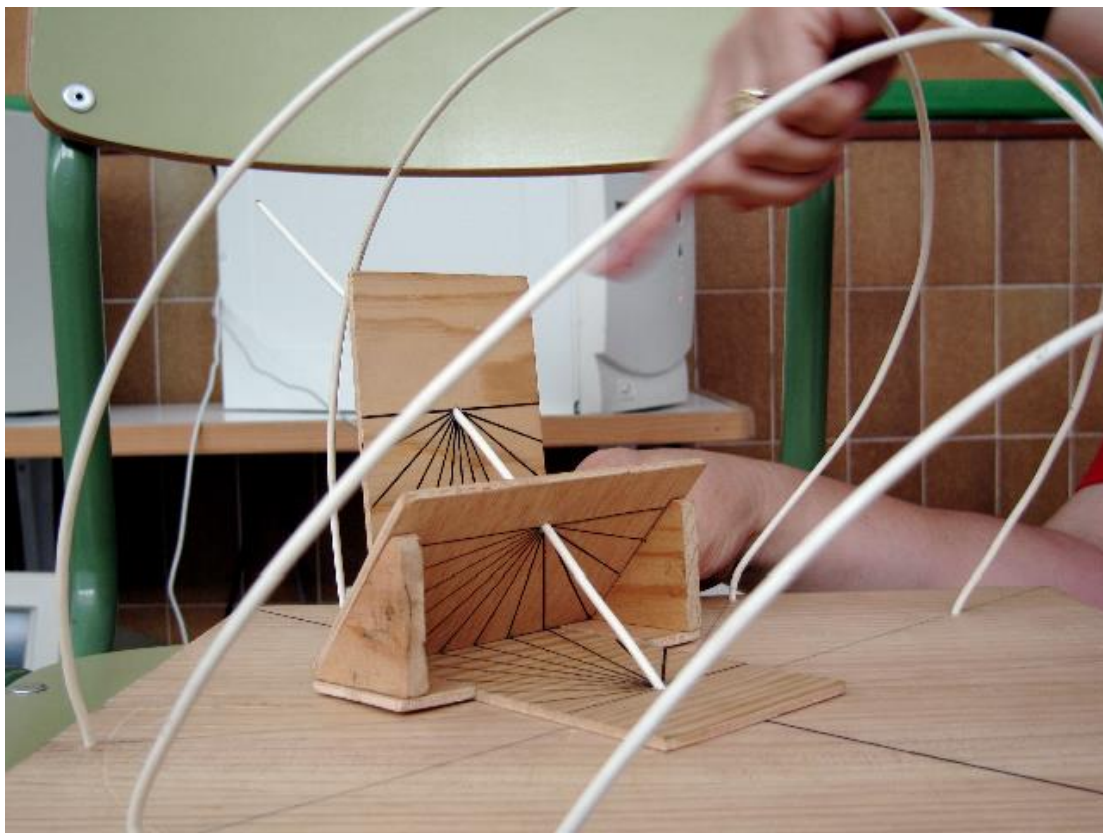

Fig. 18: The model is a huge sundial. We can consider three types.

Moving the flashlight along the Tropics of Capricorn and Cancer makes it easy to see that the path of light emitted from the flashlight produces a different conic section on the plane. In the first case (the first day of summer), the conic is almost a circle, and the enclosed area is clearly smaller than in the second case. When followed by the other parallel (first day of winter), the section is elliptical, and the enclosed area is much greater. Then the students can understand that radiation is more concentrated in the first situation, i.e., the surface temperature is higher in summer, and it is also evident in the model that the number of hours of solar insolation is greater. The natural consequence is that it is warmer in summer than in winter (figure 19).

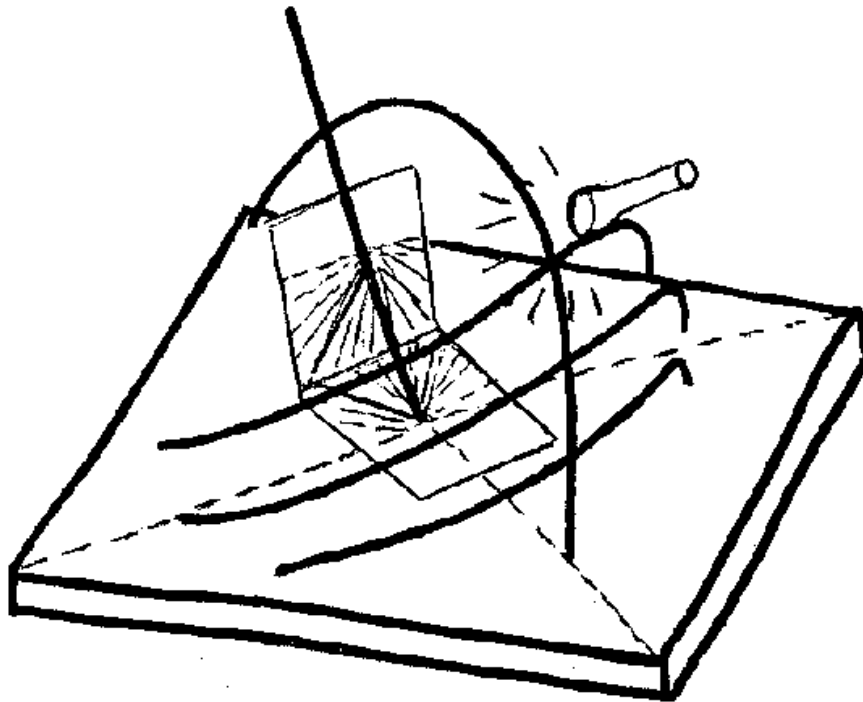

Fig. 19: The clocks and seasons.

We will take this opportunity to mention some elements that must be known to construct a sundial.

The equatorial clock is very easy to create. Just put the stylus in the direction of Earth's rotation axis, i.e., in the north-south direction (a compass can help us do so), and with a height above the plane of the horizon equal to the latitude of the site (figure 20 and 21). The stylus of any clock always will be placed in the same way.

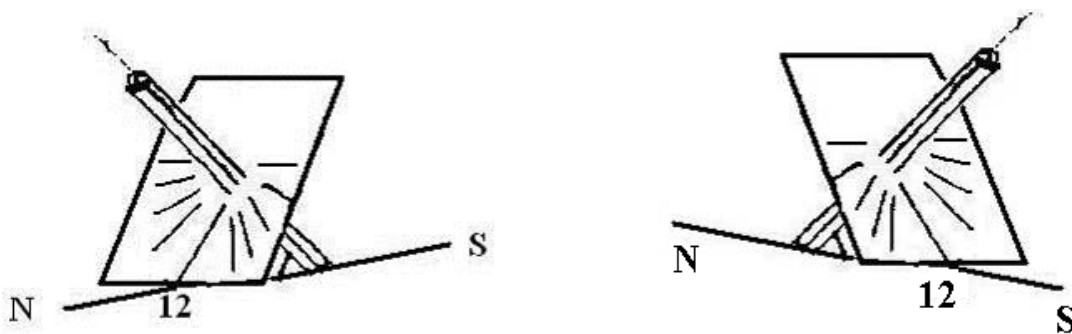

Fig. 20: Equatorial clock in used in northern hemisphere Fig. 21: Equatorial clock used in southern hemisphere

The equatorial clock hour lines are drawn at 15 degrees (figure 22a and 22b), since the Sun gives a 360 degree turn in 24 hours. If we divide 360 by 24, we get 15 degrees each hour.

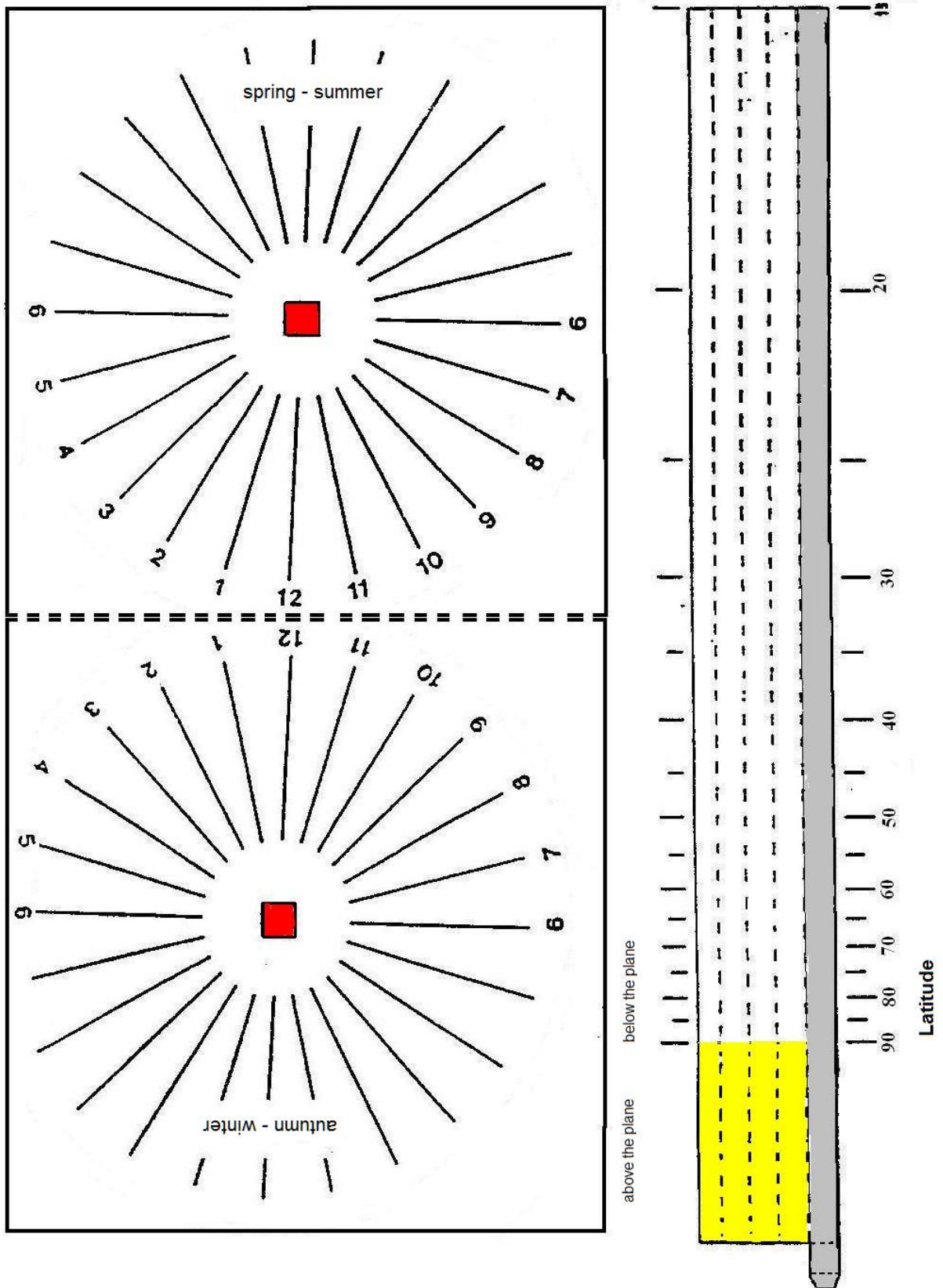

Fig. 22a and 22b: Patten for the equatorial clock.

The hour lines of a horizontally or vertically oriented clock are obtained by projecting the equatorial lines and simply considering the latitude of the place (figures 23a, 23b, 23c y 23d).

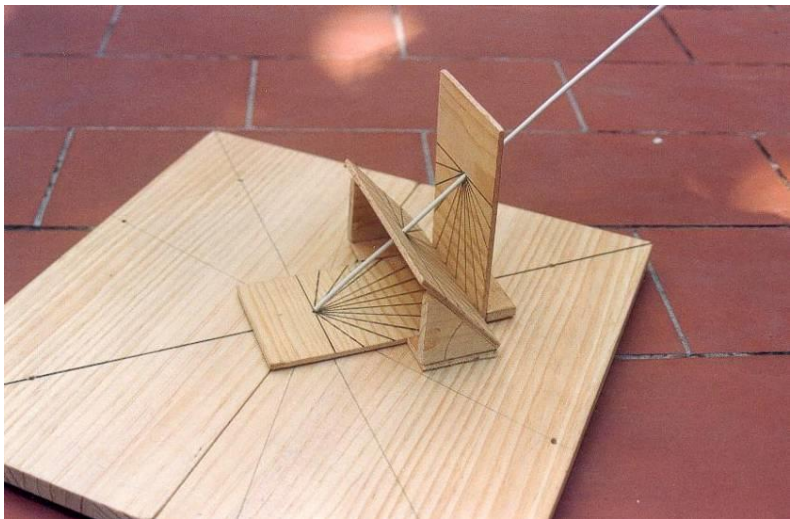
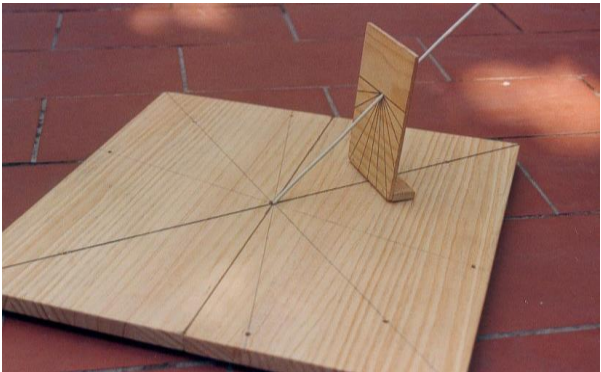
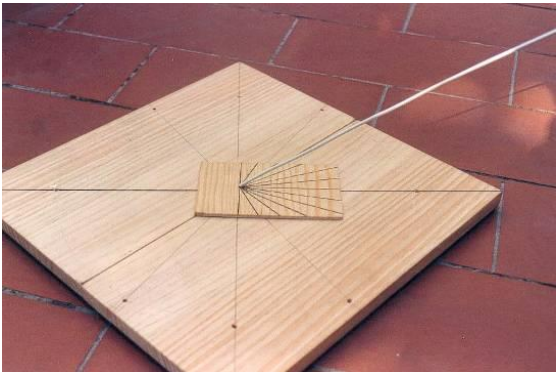
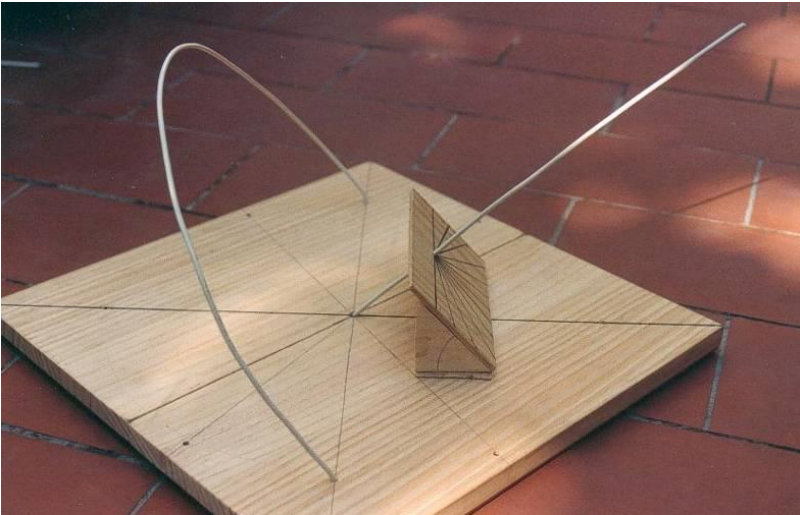

Fig. 23a, 23b, 23c y 23d: Some images of the clocks.

### Solar time and clock time of wristwatches

Sundials give solar time, which is not the same as that on the watches that we all use on our wrists. We must consider several adjustments:

#### Longitude adjustment

Earth is divided into 24 time zones from the prime meridian or Greenwich meridian. To make the longitude adjustment it is necessary to know the local longitude and the longitude of the "standard" meridian in your area. A "+" sign is added to the east and signed "-" to the west. We must express the lengths in hours, minutes and seconds (1 degree = 4 minutes).

#### Summer/winter adjustment

Almost all countries have a summer ("daylight savings") and winter times. An hour is usually added in the summer. The time change in summer/winter is a decision of the country's government.

#### Time equation adjustment

Earth revolves around the Sun according to Kepler's law of areas for an eclipse, i.e., it is not a constant motion, which creates a serious problem for mechanical watches. Mechanical clocks define the average time as the average over a full year of time. The Equation of Time is the difference between "Real Solar Time" and "Average Time". This equation is tabulated on Table 1.

days	Gen	Feb	Mar	Apr	May	Jun	Jul	Aug	Sep	Oct	Nov	Dec
1	+3.4	+13.6	+12.5	+4.1	-2.9	-2.4	+3.6	+6.3	+0.2	-10.1	-16.4	-11.2
6	+5.7	+5.1	+11.2	+2.6	-3.4	-1.6	+4.5	+5.9	-1.5	-11.7	-16.4	-9.2
11	+7.8	+7.3	+10.2	+1.2	-3.7	-0.6	+5.3	+5.2	-3.2	-13.1	-16.0	-7.0
16	+9.7	+9.2	+8.9	-0.1	-3.8	+0.4	+5.9	+4.3	-4.9	-14.3	-15.3	-4.6
21	+11.2	+13.8	+7.4	-1.2	-3.6	+1.5	+6.3	+3.2	-6.7	-15.3	-14.3	-2.2
26	+12.5	+13.1	+5.9	-2.2	-3.2	+2.6	+6.4	+1.9	-8.5	-15.9	-12.9	+0.3
31	+13.4		+4.4		-2.5		+6.3	+0.5		-16.3		+2.8

Table 1: Time equation

**Solar time + Total adjustment = Wristwatch clock time**

Example 1: Barcelona (Spain) on May 24<sup>th</sup>.

Adjustment	Comment	Result
1. Longitude	Barcelona is in the same "standard" zone as Greenwich.	-8.7 m
2. DST	May has DST +1h	+ 60 m
3. Time equation	Read the table for the date May 24	-3.6 m
Total		+47.7 m

For example, at 12:00 solar time, our wristwatch says:

**(Solar time) 12h + 47.7 m = 12h 47.7 m (Wristwatch time)**

Example 2: Tulsa, Oklahoma (United States) November 16<sup>th</sup>.

Adjustment	Comment	Result
1. Longitude	The “standard” meridian of Tulsa is at 90° W.	+24 m
2. DST	November has none	
3. Time equation	We read the table for the date November 16	-15.3 m
Total		+ 8.7 m

For example, at 12:00 solar time, our wristwatch says:  
**(Solar time) 12h + 8.7 m = 12h 8.7 m (Wristband clock time)**

### Orientation

Another difficulty for students is orientation. In a general astronomy course, we have to introduce a sense of direction. It is possible that our students will never study astronomy again. For students in the northern hemisphere, the minimum outcome to be expected from a course of astronomy is that students are able to recognize where the North is, know that the trajectory of the Sun is above the southern horizon, know that the planets move across the horizon, and in particular learn to locate the various geographical features of their city. For example, over the horizon of Barcelona (figures 24a and 24b) students can consider various options regarding the position of the Sun, Moon, and certain constellations on the horizon. The two mountains that we see are approximately in opposite positions, but that does not mean anything for the students, and they usually have troubles distinguishing that certain drawings are possible while others are not. They know the theory, but the practice is not enough if they do not understand the different possibilities.

Using the model designed to resolve the drawbacks mentioned in the previous section was very effective in clarifying many issues related to orientation on the local horizon in a way that was not initially planned.

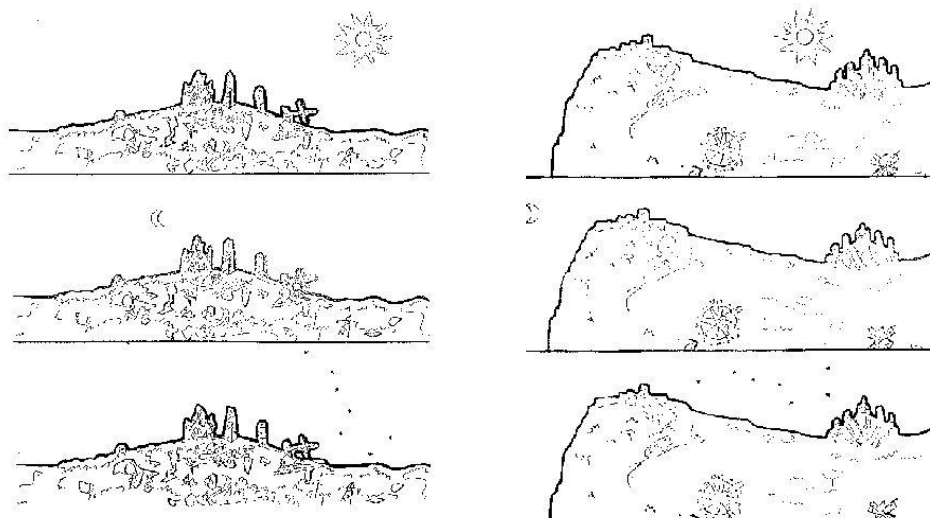

Fig. 24a: North-East horizon of Barcelona. Fig. 24b: South-West horizon of Barcelona.

It is worth mentioning that this model is useful in explaining the local position of the celestial sphere during the day and night. It really helps to better understanding the movement of the

Sun (and other members of the Solar System moving in the near area). Using the proposed model, students understand that a bright star in the Polaris area can never be a planet.



Fig. 25a: The model with primary school students, Fig. 25b: The large-scale model in the Science Park of Granada.

It is a good investment to make a large-scale model. In this case, students and even adults can get into it and check the Sun's position compared to the equator and the parallels that correspond to the first day of summer and winter solstice (figure 25a). Some science museums have built this type of model (figure 25b).

After using the model, students can discern things that they previously would not have. For example, now it is very clear that the Sun does not rise and set perpendicular to the horizon except at the equator.

## Bibliography

- Ros, R.M., *De l'intérieur et de l'extérieur*, Les Cahiers Clairaut, 95, p.1-5, Orsay, 2001.
- Ros, R.M., *Laboratorio de Astronomía*, Tribuna de Astronomía, 154, p.18-29, 1998.
- Ros, R.M., *Sunrise and sunset positions change every day*, Proceedings of 6th EAAE International Summer School, 177, 188, Barcelona, 2002.
- Ros, R.M., Capell, A., Colom, J., *El planisferio y 40 actividades más*, Antares, Barcelona, 2005.
- Ros, R.M., Lanciano, N., *El horizonte en la Astronomía*, Astronomía Astrofotografía y Astronáutica, 76, p.12-20, 1995.



## Stellar, solar, and lunar demonstrators

**Rosa M. Ros, Francis Berthomieu**

International Astronomical Union, Technical University of Catalonia (Barcelona, Spain), CLEA (Nice, France)

### Summary

This worksheet presents a simple method to explain how the apparent motions of stars, the Sun, and the Moon are observed from different places on Earth. The procedure consists of building simple models that allows us to demonstrate how these movements are observed from different latitudes.

### Goals

- Understand the apparent motions of stars as seen from different latitudes.
- Understand the apparent motions of the Sun as seen from different latitudes.
- Understand the Moon's movement and shapes as seen from different latitudes.

### The idea behind the demonstrator

It is not simple to explain how the apparent motions of the Sun, the Moon, or stars are observed from the Earth. Students know that the Sun rises and sets every day, but they are surprised to learn that the Sun rises and sets at a different point every day or that solar trajectories can vary according to the local latitude. The demonstrators simplify and explain the phenomenon of the midnight sun and the solar zenith passage. In particular, the demonstrators can be very useful for understanding the movement of translation and justify some latitude differences.

It is easy to remember the shape and appearance of each constellation by learning the mythological stories and memorizing the geometric rules for finding the constellation in the sky. However, this only works at a fixed location on Earth. Because of the motion of the Celestial Sphere, an observer that lives at the North Pole can see all the stars in the Northern Hemisphere and one who lives at the South Pole can see all the stars in the Southern Hemisphere. But what do observers see that live at different latitudes?

## The stellar demonstrator: why are there invisible stars?

Everything gets complicated when the observer lives in a zone that is not one of the two poles. In fact, this is true for most observers. In this case, stars fall into three different categories depending on their observed motions (for each latitude): circumpolar stars, stars that rise and set, and invisible stars (figure 1). We all have experienced the surprise of discovering that one can see some stars of the Southern Hemisphere while living in the Northern Hemisphere. Of course it is similar to the surprise that it is felt when the phenomenon of the midnight sun is discovered.

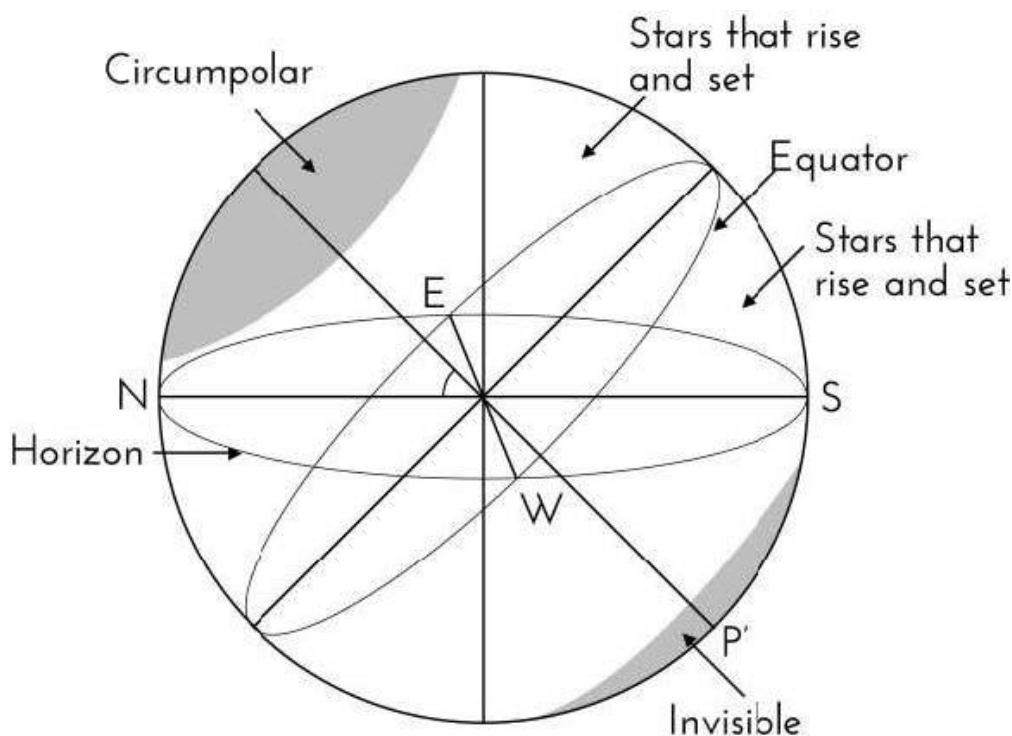

Fig 1: Three different types of stars (as seen from a specific latitude): circumpolar, stars that rise and set, and invisible stars.

Depending on their age, most students can understand fairly easily why some stars appear circumpolar from the city where they live. However, it is much more difficult for them to imagine which ones would appear circumpolar as seen from other places in the world. If we ask whether one specific star (e.g., Sirius) appears to rise and set as seen from Buenos Aires, it is difficult for students to figure out the answer. Therefore, we will use the stellar demonstrator to study the observed motions of different stars depending on the latitude of the place of observation.

## The main goal of the demonstrator

The main objective is to discover which constellations are circumpolar, which rise and set, and which are invisible at specific latitudes. If we observe the stars from latitude of around  $45^\circ$  N, it is clear that we can see quite a lot of stars visible from the Southern Hemisphere that rise and set every night (figure 1).

In our case, the demonstrator should include constellations with varying declinations (right ascensions are not as important at this stage). It is a very good idea to use constellations that are familiar to the students. These can have varying right ascensions so they are visible during different months of the year (figure 2).

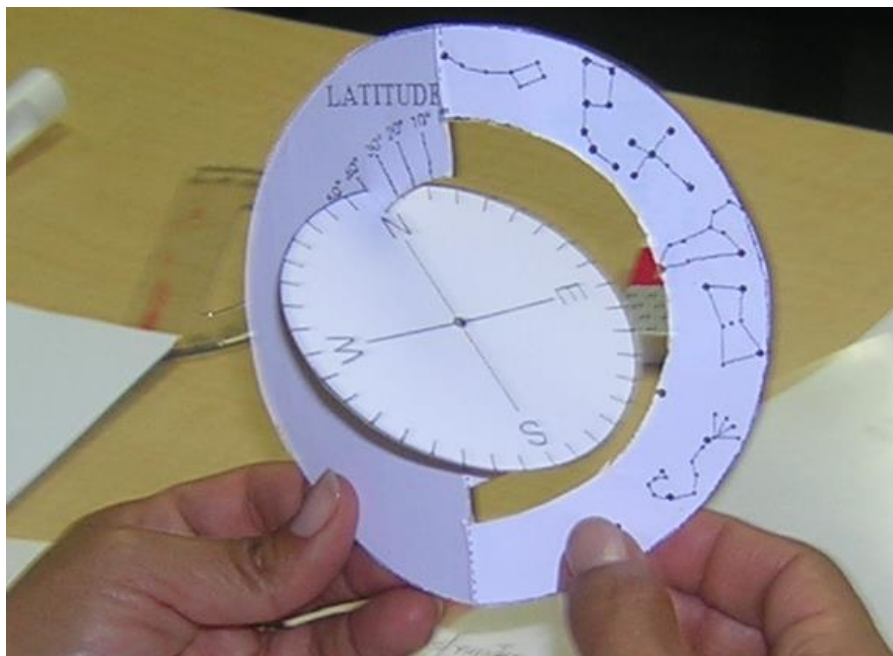

Fig 2: Using the demonstrator: this is an example of a demonstrator for the Northern Hemisphere using constellations from Table 1.

When selecting the constellation to be drawn, only the bright stars should be used so that its shape is easily identified. It is preferable not to use constellations that are on the same meridian, but rather to focus on choosing ones that would be well known to the students (Table 1). If you are interested in making a model for each season, you can make four different demonstrators, one for each season for your hemisphere. You should use constellations that have different declinations, but that have right ascension between 21h and 3h for the autumn (spring), between 3h and 9h for the winter (summer), between 9h and 14h for spring (autumn), and between 14h and 21h for the summer (winter) in the Northern (Southern) hemisphere for the evening sky.

<i>Constellation</i>	<i>Maximum declination</i>	<i>Minimum declination</i>
Ursa Minor	+90°	+70°
Ursa Major	+60°	+50°
Cygnus	+50°	+30°
Leo	+30°	+10°
Orion and Sirius	+10°	-10°
Scorpius	-20°	-50°
South Cross	-50°	-70°

Table 1: Constellations appearing in the demonstrator shown in figure 1.

If we decide to select constellations for only one season, it may be difficult to select a constellation between, for example, 90°N and 60°N, another between 60°N and 40°N, another between 40°N and 20°N, and another between 20°N and 20°S, and so on, without overlapping and reaching 90°S. If we also want to select constellations that are well known to students, with a small number of bright stars that are big enough to cover the entire meridian, it may be difficult to achieve our objective. Because big, well-known, bright constellations do not cover the whole sky throughout the year, it may be easier to make only one demonstrator for the entire year.

There is also another argument for making a unique demonstrator. Any dispute regarding the seasons take place only at certain latitudes of both hemispheres.

### Making the demonstrator

To obtain a sturdy demonstrator (figure 3), it is a good idea to glue together the two pieces of cardboard before cutting (figures 4 and 5). It is also a good idea to construct another one, twice as big, for use by the teacher.



Fig. 3: Making the stellar demonstrator.

The instructions to make the stellar demonstrator are given below.

Demonstrator for Northern Hemisphere

- a) Make a photocopy of figures 4 and 5 on cardboard.
- b) Cut both pieces along the continuous line (figures 4 and 5).
- c) Remove the black areas from the main piece (figure 4).
- d) Fold the main piece (figure 4) along the straight dotted line. Doing this a few times will make the demonstrator easier to use.
- e) Cut a small notch above the “N” on the horizon disk (figure 5). The notch should be large enough for the cardboard to pass through it.
- f) Glue the North-East quadrant of the horizon disk (figure 5) onto the grey quadrant of the main piece (figure 4). It is very important to have the straight north-south line following the double line of the main piece. Also, the “W” on the horizon disk must match up with latitude  $90^\circ$ .
- g) When you place the horizon disk into the main piece, make sure that the two stay perpendicular.
- h) It is very important to glue the different parts carefully to obtain the maximum precision.

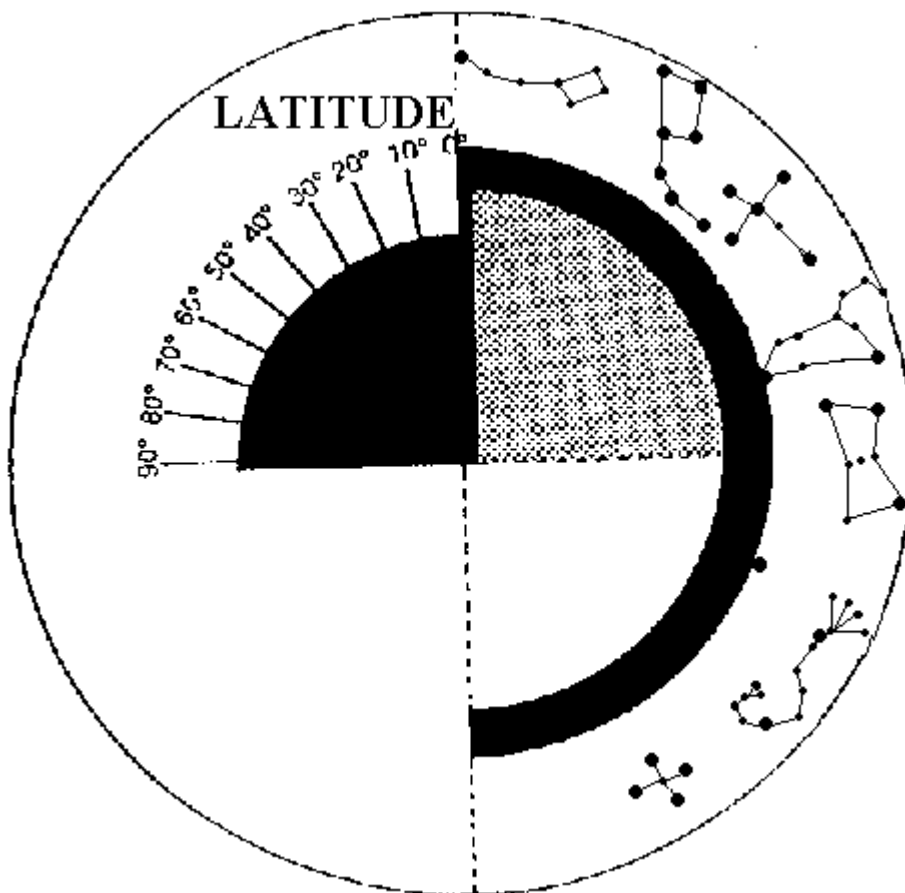

Fig. 4: The main part of the stellar demonstrator for the Northern Hemisphere.

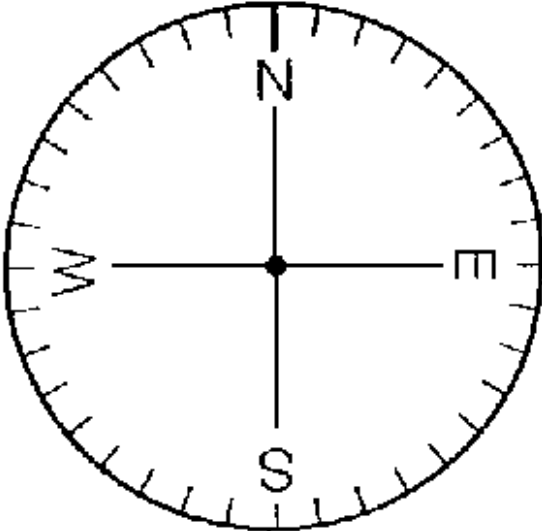

Fig. 5: The horizon disc.

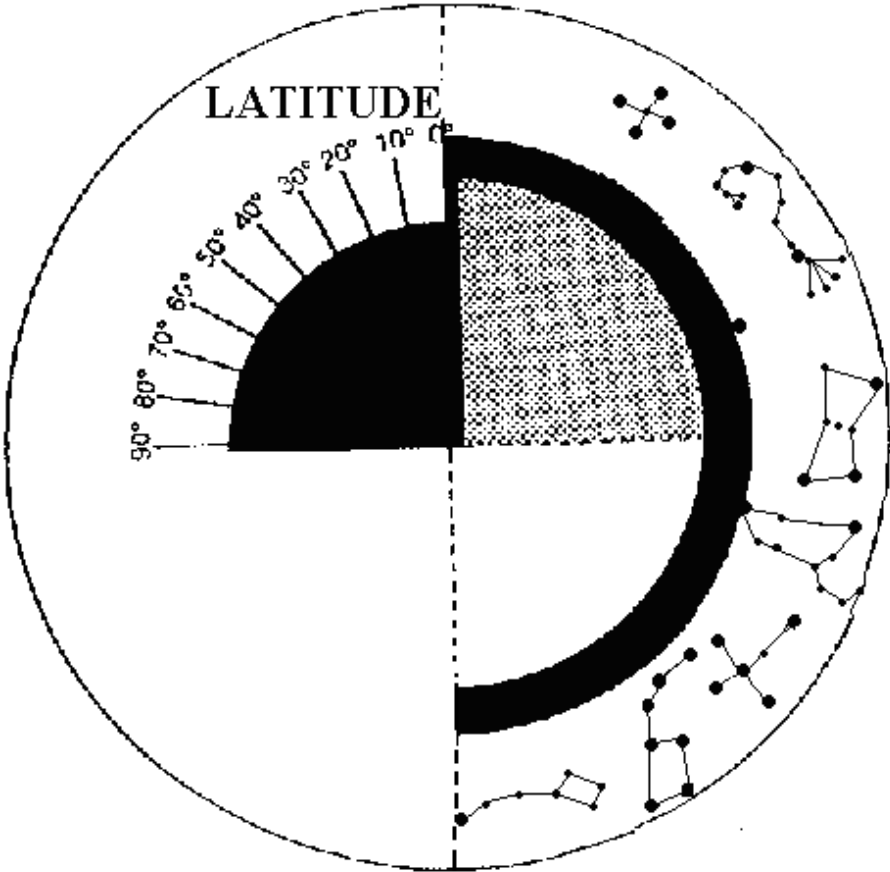

Fig. 6: The main part of the stellar demonstrator for the Southern Hemisphere.

### Demonstrator for Southern Hemisphere

- a) Make a photocopy of figures 5 and 6 on cardboard.
- b) Cut both pieces along the continuous line (figures 5 and 6).
- c) Remove the black areas from the main piece (figure 6).
- d) Fold the main piece (figure 6) along the straight dotted line. Doing this a few times will make the demonstrator easier to use.
- e) Cut a small notch on the “S” of the horizon disk (figure 5). It should be large enough for the cardboard to pass through it.
- f) Glue the South-West quadrant of the horizon disk (figure 5) onto the grey quadrant of the main piece (figure 6). It is very important to have the straight north-south line following the double line of the main piece. Also the “E” on the horizon disk must match up with latitude  $90^\circ$ .
- g) When you place the horizon disk into the main piece, make sure that the two stay perpendicular.
- h) It is very important to glue the different parts carefully to obtain the maximum precision.

Choose which stellar demonstrator you want to make depending on where you live. You can also make a demonstrator by selecting your own constellations following different criteria.

For instance, you can include constellations visible only for one season, constellations visible only for one month, etc. For this, you must consider only constellations with right ascensions between two specific values. Then draw the constellations with their declination values on figure 7. Notice that each sector corresponds to  $10^\circ$ .

### Demonstrator applications

To begin using the demonstrator you have to select the latitude of your place of observation. We can travel over the Earth’s surface on an imaginary trip using the demonstrator.

Use your left hand to hold the main piece of the demonstrator (figure 4 or 6) by the blank area (below the latitude quadrant). Select the latitude and move the horizon disk until it shows the latitude chosen. With your right hand, move the disk with the constellations from right to left several times.

You can observe which constellations are always on the horizon (circumpolar), which constellations rise and set, and which of them are always below the horizon (invisible).

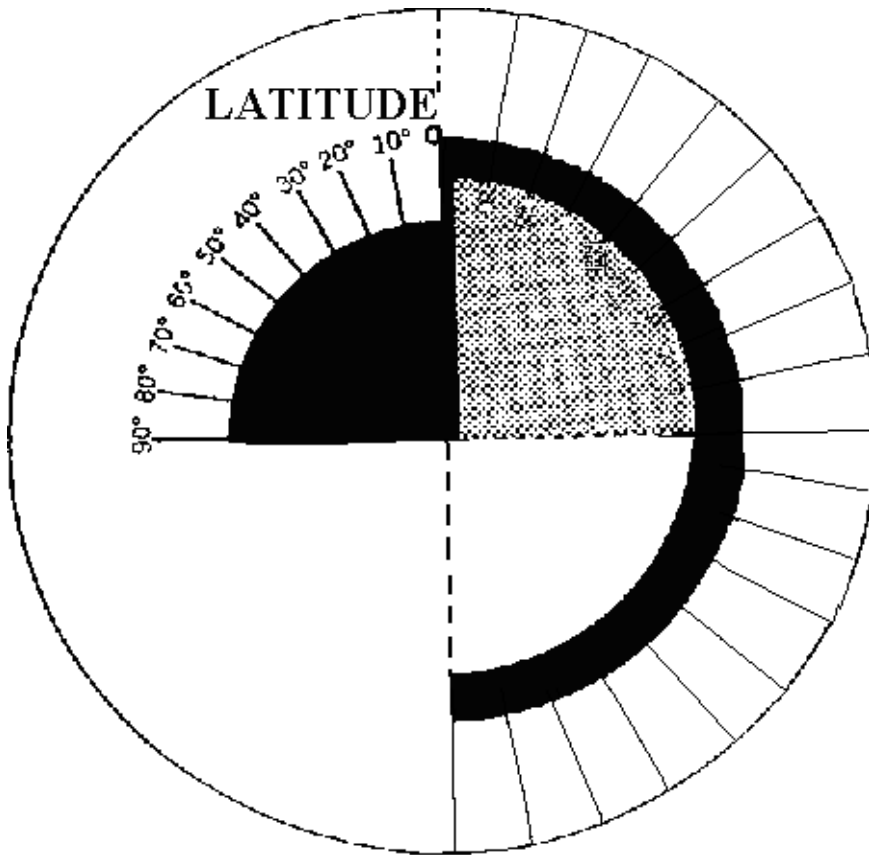

Fig. 7: The main part of the stellar demonstrator for the Northern or Southern Hemispheres.

- *Star path inclination relative to the horizon*

With the demonstrator, it is very easy to observe how the angle of the star path relative to the horizon changes depending on the latitude (figures 8 and 9).

If the observer lives on the equator (latitude  $0^\circ$ ) this angle is  $90^\circ$ . On the other hand, if the observer is living at the North or South Pole, (latitude  $90^\circ$  N or  $90^\circ$  S) the star path is parallel to the horizon. In general, if the observer lives in a city at latitude  $L$ , the star path inclination on the horizon is  $90^\circ$  minus  $L$  every day.

We can verify this by looking at figures 8 and 9. The photo in figure 9 was taken in Lapland (Finland) and the one in figure 8 in Montseny (near Barcelona, Spain). Lapland is at a higher latitude than Barcelona so the star path inclination is smaller.





Fig. 8a and 8b: Stars rising in Montseny (near Barcelona, Spain). The angle of the star path relative to the horizon is  $90^\circ$  minus the latitude (Photo: Rosa M. Ros).



Fig. 9a and 9b: Stars setting in Enontekiö in Lapland (Finland). The angle of the star path relative to the horizon is  $90^\circ$  minus the latitude. Note that the star paths are shorter than in the previous photo because the aurora borealis forces a smaller exposure time (Photo: Irma Hannula).

Using the demonstrator in this way, the students can complete the different activities below.

- 1) If we choose the latitude to be  $90^\circ\text{N}$ , the observer is at the North Pole. We can see that all the constellations in the Northern Hemisphere are circumpolar. All the ones in the Southern Hemisphere are invisible and there are no constellations which rise and set.
- 2) If the latitude is  $0^\circ$ , the observer is on the equator, and we can see that all the constellations rise and set (perpendicular to the horizon). None are circumpolar or invisible.
- 3) If the latitude is  $20^\circ$  (N or S), there are less circumpolar constellations than if the latitude is  $40^\circ$  (N or S, respectively). But there are a lot more stars that rise and set if the latitude is  $20^\circ$  instead of  $40^\circ$ .
- 4) If the latitude is  $60^\circ$  (N or S), there are a lot of circumpolar and invisible constellations, but the number of constellations that rise and set is reduced compared to latitude  $40^\circ$  (N or S respectively).

## The solar demonstrator: why the Sun does not rise at the same point every day

It is simple to explain the observed movements of the sun from the Earth. Students know that the sun rises and sets daily, but feel surprised when they discover that it rises and sets at different locations each day. It is also interesting to consider the various solar trajectories according to the local latitude. And it can be difficult trying to explain the phenomenon of the midnight sun or the solar zenith passage. Especially the simulator can be very useful for understanding the movement of translation and justify some latitude differences.

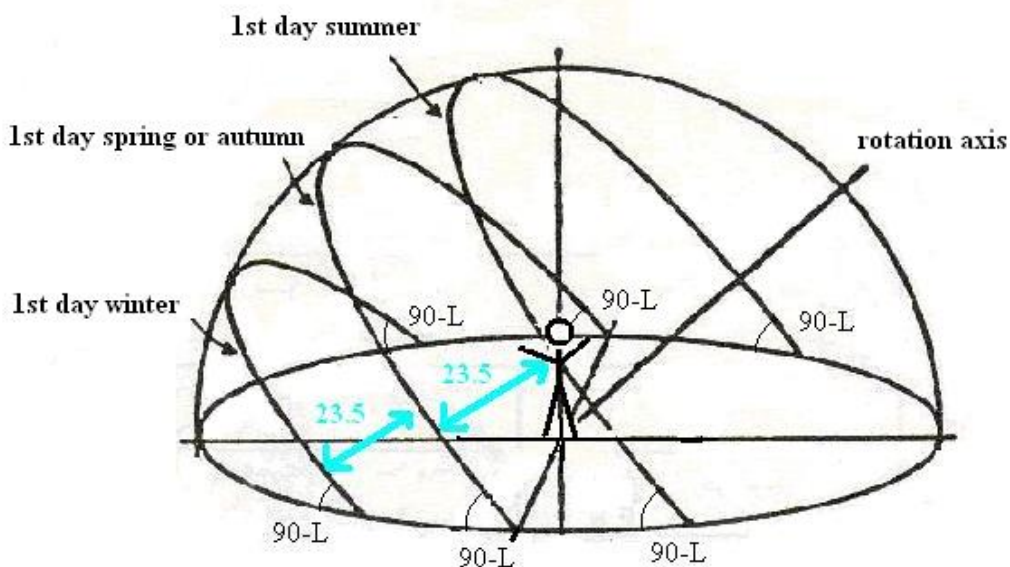

Fig. 10: Three different solar paths (1<sup>st</sup> day of spring or autumn, 1<sup>st</sup> day of summer, and 1<sup>st</sup> day of winter).

### Making the demonstrator

To make the solar demonstrator, we have to consider the solar declination, which changes daily. Then we have to include the capability of changing the Sun's position according to the seasons. For the first day of spring and autumn, its declination is  $0^\circ$  and the Sun is moving along the equator. On the first day of summer (winter in the Southern Hemispheres), the Sun's declination is  $+23.5^\circ$  and on the first day of winter (summer in the Southern Hemisphere) it is  $-23.5^\circ$  (figure 10). We must be able to change these values in the model if we want to study the Sun's trajectory.

To obtain a sturdy demonstrator (figures 11a y 11b), it is a good idea to glue two pieces of cardboard together before cutting them. Also you can make one of the demonstrators twice as large, for use by the teacher.

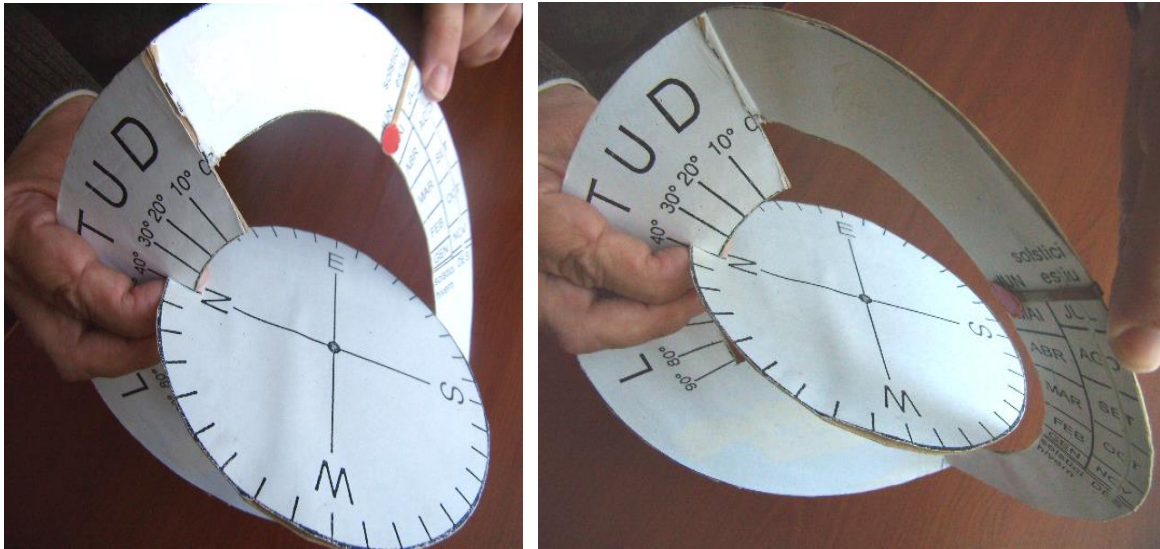

Fig. 11a and 11b: Preparing the solar demonstrator for the Northern Hemisphere at latitude  $+40^\circ$ .

**The build instructions listed below.**

Demonstrator for Northern Hemisphere

- a) Make a photocopy of figures 12 and 13 on cardboard.
- b) Cut both pieces along the continuous line (figures 12 and 13).
- c) Remove the black areas from the main piece (figure 13).
- d) Fold the main piece (figure 13) along the straight dotted line. Doing this a few times will make the demonstrator easier to use.
- e) Cut a small notch above the “N” on the horizon disk (figure 13). The notch should be large enough for the cardboard to pass through it.
- f) Glue the North-East quadrant of the horizon disk (figure 13) onto the grey quadrant of the main piece (figure 12). It is very important to have the straight north-south line following the double line of the main piece. Also, the “W” on the horizon disk must match up with latitude  $90^\circ$ .
- g) When you place the horizon disk into the main piece, make sure that the two stay perpendicular.
- h) It is very important to glue the different parts carefully to obtain the maximum precision.
- i) In order to put the Sun in the demonstrator, paint a circle in red on a piece of paper. Cut it out and put it between two strips of sticky tape. Place this transparent strip of tape with the red circle over the declination area in figure 12. The idea is that it should be easy to move this strip up and down in order to situate the red point on the month of choice.

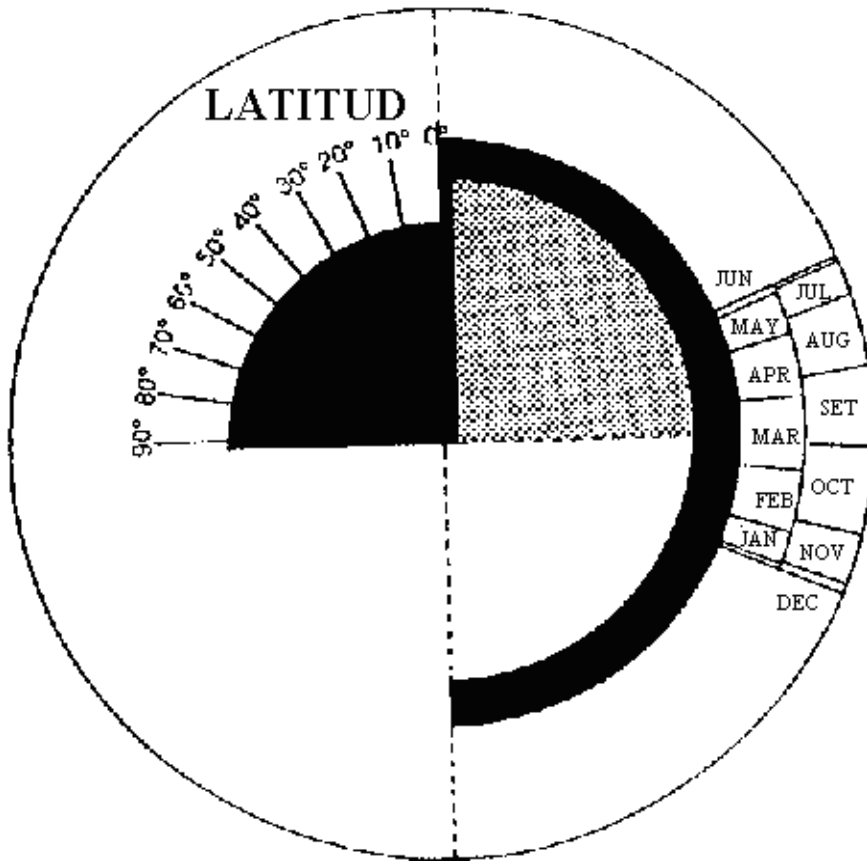

Fig. 12: The main part of the solar demonstrator for the Northern Hemisphere.

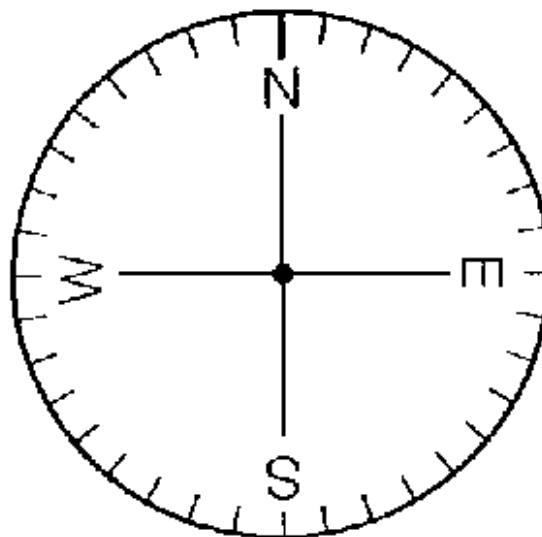

Fig. 13: The horizon disk.

To build the solar demonstrator in the Southern Hemisphere you can follow similar steps, but replace figure 12 with figure 14.

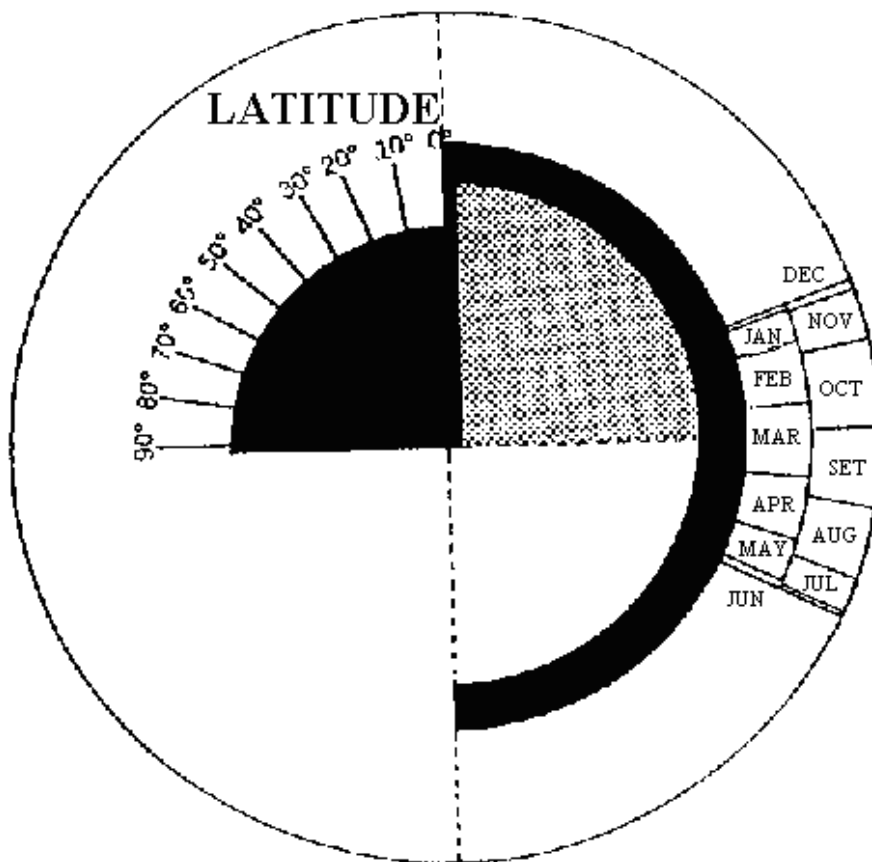

Fig. 14: The main part of the solar demonstrator for the Southern Hemisphere.

### Demonstrator for Southern Hemisphere

- a) Make a photocopy of figures 13 and 14 on cardboard.
- b) Cut both pieces along the continuous line (figures 13 and 14).
- c) Remove the black areas from the main piece (figure 14).
- d) Fold the main piece (figure 14) along the straight dotted line. Doing this a few times will make the demonstrator easier to use.
- e) Cut a small notch above the “S” on the horizon disk (figure 13). The notch should be large enough for the cardboard to pass through it.
- f) Glue the South-West quadrant of the horizon disk (figure 13) onto the grey quadrant of the main piece (figure 14). It is very important to have the straight north-south line following the double line of the main piece. Also, the “E” on the horizon disk must match up with latitude 90°.
- g) When you place the horizon disk into the main piece, make sure that the two stay perpendicular.
- h) It is very important to glue the different parts carefully to obtain the maximum precision.
- i) In order to put the Sun in the demonstrator, paint a circle in red on a piece of paper. Cut it out and put it between two strips of sticky tape. Place this transparent strip of tape with the red circle over the declination area in figure 14. The idea is that it should be easy to move this strip up and down in order to situate the red point on the month of choice.

j) Using the solar demonstrator

To use the demonstrator you have to select your latitude. Again, we can travel over the Earth's surface on an imaginary trip using the demonstrator.

We will consider three areas:

1. Places in an intermediate area in the Northern or Southern Hemispheres
2. Places in polar areas
3. Places in equatorial areas

1. - Places in intermediate areas in the Northern or Southern Hemispheres: SEASONS

- *Angle of the Sun's path relative to the horizon*

Using the demonstrator it is very easy to observe that the angle of the Sun's path relative to the horizon depends on the latitude. If the observer lives on the equator (latitude  $0^\circ$ ) this angle is  $90^\circ$ . If the observer lives at the North or South Pole (latitude  $90^\circ$  N or  $90^\circ$  S), the Sun's path is parallel to the horizon. In general, if the observer lives in a city at latitude  $L$ , the inclination of the Sun's path relative to the horizon is  $90$  minus  $L$  every day. We can verify this by looking at figures 15 and 16. The picture in figure 15 was taken in Lapland (Finland), and the one in figure 16 in Gandia (Spain). Lapland is at higher latitude than Gandia, so the inclination of the Sun's path is smaller.

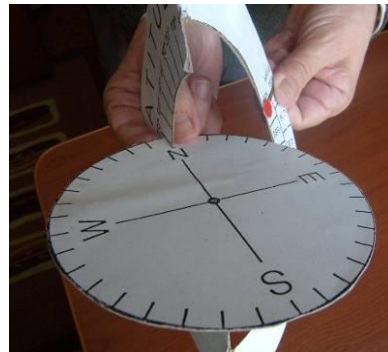

Fig. 15a y 15b: Sun rising in Enontekiö in Lapland (Finland). The angle of the Sun's path relative to the horizon is the co-latitude ( $90^\circ$  minus the latitude) (Photo: Sakari Ekko).

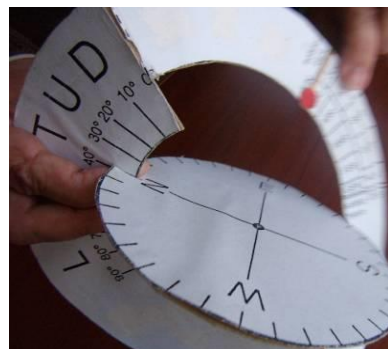

Fig. 16a y 16b: Sun rising in Gandia (Spain). The angle of the Sun's path relative to the horizon is  $90$  minus the latitude (Photo: Rosa M. Ros).

- ***The height of the Sun's path depending on the season***

1a) the Northern Hemisphere

Using the demonstrator for your city (select the latitude of your city), it is easy to verify that the altitude (height) of the Sun above the horizon changes according to the season. For instance, on the first day of spring the declination of the Sun is  $0^\circ$ . We can put the Sun on March 21<sup>st</sup>. Then we can move the Sun exactly along the equator from the East towards the West. We can see that the Sun's path is at a certain height over the horizon.

At the same latitude we repeat the experiment for different days. When we move the Sun along the equator on the 1<sup>st</sup> day of summer, the 21<sup>st</sup> of June, (solar declination  $+23^\circ.5$ ), we observe that the Sun's path is higher than on the 1<sup>st</sup> day of spring. Finally, we repeat the experiment for the 1<sup>st</sup> day of winter, the 21<sup>st</sup> of December (solar declination  $-23^\circ.5$ ). We can see that in this case the Sun's path is lower. On the 1<sup>st</sup> day of autumn the declination is  $0^\circ$  and the Sun's path follows the equator in a similar way as it did on the 1<sup>st</sup> day of spring.



Fig. 17a y 17b: The Sun's path in summer and winter in Norway. It is clear that the Sun is much higher in summer than in winter. This is why there are many more hours of sunlight during summer.

1b) the Southern Hemisphere

Using the demonstrator for your city (select the latitude of your city), it is easy to verify that the altitude of the Sun above the horizon changes according to the season. For instance, on the first day of spring the declination of the Sun is  $0^\circ$ . We can put the Sun on September 23<sup>rd</sup>. Then we can move the Sun along the equator from the East towards the West. We can see that the Sun's path is at a certain height over the horizon.

At the same latitude we can repeat the experiment for different days. On the 1<sup>st</sup> day of summer, the 21<sup>st</sup> of December (solar declination  $-23^\circ.5$ ), when we move the Sun along the equator, we observe that the Sun's path is higher than on the 1<sup>st</sup> day of spring.

Finally, we can repeat the experiment at the same latitude for the 1<sup>st</sup> day of winter, the 21<sup>st</sup> of June (solar declination  $+23^\circ.5$ ). We can see that in this case the Sun's path is lower. On the 1<sup>st</sup>

day of autumn the declination is  $0^\circ$  and the Sun's path follows the equator in a similar way as on the 1<sup>st</sup> day of spring.

Of course if we change the latitude, the height of the Sun's path changes, but even then the highest path is still always on the 1<sup>st</sup> day of summer and the lowest on the 1<sup>st</sup> day of winter.

Remarks:

In the summer, when the Sun is higher, the Sun's light hits the Earth at an angle that is more perpendicular to the horizon. Because of this, the radiation is concentrated in a smaller area and the weather is hotter. Also in summertime, the number of hours of sunlight is larger than in winter. This also increases temperatures during the summer.

- *The Sun rises and sets in a different place every day*

In the preceding experiments, if we had focused our attention on where the Sun rises and sets, we would have observed that it is not the same place every day. In particular, the distance on the horizon between the sunrise (or sunset) on the 1<sup>st</sup> day of two consecutive seasons increases with the increasing latitude (figure 18a y 18b).

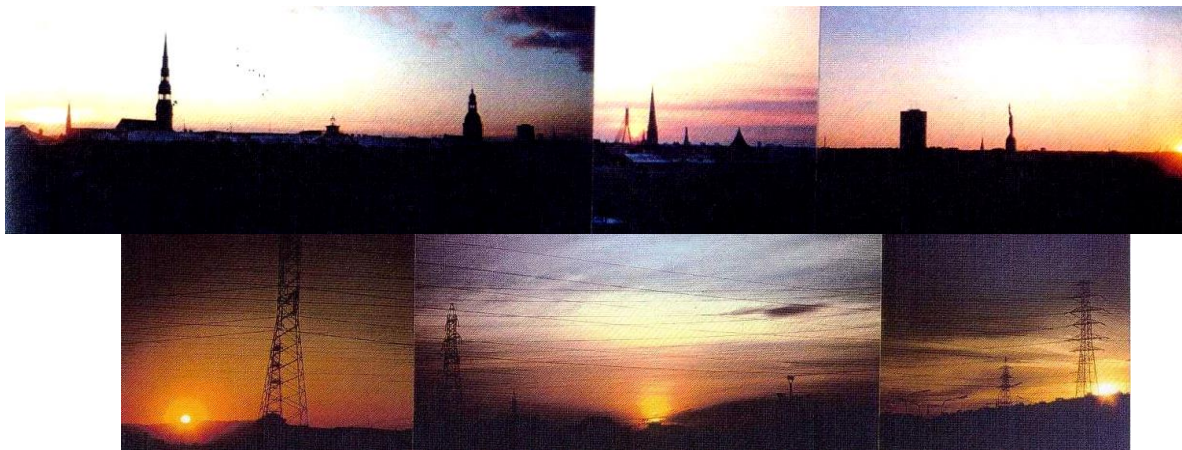

Fig. 18a y 18b: Sunsets in Riga (Latvia) and Barcelona (Spain) the first day of each season (left/winter, center/spring or autumn, right/summer). The central sunsets in both photos are on the same line. It is easy to observe that the summer and winter sunsets in Riga (higher latitude) are much more separated than in Barcelona (Photos: Ilgonis Vilks, Latvia and Rosa M. Ros, Spain).



Fig. 19a: Sunrises on the first day of 1<sup>st</sup> day of spring or autumn, Fig. 19b: Sunrises on the first day 1<sup>st</sup> day of summer, Fig. 19c: Sunrises on the first day of 1<sup>st</sup> day of winter



This is very simple to simulate using the demonstrator. Just mark the position of the Sun in each season for two different latitudes, for instance  $60^\circ$  and  $40^\circ$  (figure 19a, 19b y 19c).

The illustrations in figures 18 and 19 are for the Northern Hemisphere, but the same concepts hold for the Southern Hemisphere (figure 20a y 20b). The only difference is the timing of the seasons.



Fig. 20a and 20b: Sunsets in La Paz (Bolivia) and Esquel (Argentina) the first day of each season (left/summer, centre/spring and autumn, right/winter). The central sunsets in both photos are on the same line, it is easy to observe that the summer and winter sunsets in Esquel (higher latitude) are much more separate than in La Paz (Photos: Juan Carlos Martínez, Colombia and Nestor Camino, Argentina).

#### Remarks:

The Sun does not rise exactly in the East and does not set exactly in the West. Although this is a generally accepted idea, it is not really true. It only occurs on two days every year: the 1<sup>st</sup> day of spring and the 1<sup>st</sup> day of autumn at all latitudes.

Another interesting fact is that the Sun crosses the meridian (the imaginary line that goes from the North Pole to the zenith to the South Pole) at midday at all latitudes (in solar time). This can be used for orientation.

## 2. - Polar regions: MIDNIGHT SUN

- ***Polar summer and polar winter***

If we introduce the polar latitude in the demonstrator ( $90^\circ$  N or  $90^\circ$  S depending on the pole under consideration) there are three possibilities. If the Sun declination is  $0^\circ$ , the Sun is moving along the horizon, which is also the equator.

If the declination coincides with the 1<sup>st</sup> day of summer, the Sun moves parallel to the horizon. In fact the Sun always moves parallel to the horizon from the second day of spring until the last day of summer. That means half a year of sunlight.

On the 1<sup>st</sup> day of autumn the Sun again moves along the horizon. But beginning on the second day of the autumn until the last day of winter, the Sun moves parallel to the horizon but below it. That means half a year of night.

Of course the above example is the most extreme situation. There are some northern latitudes where the Sun’s path is not parallel to the horizon. At these latitudes there are still no sunrises or sunsets because the local latitude is too high. In these cases we can observe what is known as “the midnight Sun”.

- **Midnight Sun**

If we select on the demonstrator the latitude 70° N (or 70° S depending on the hemisphere under consideration), we can simulate the concept of the midnight sun. If we put the Sun on the 1<sup>st</sup> day of summer, the 21<sup>st</sup> of June, in the Northern Hemisphere (or the 21<sup>st</sup> of December in the Southern Hemisphere), we can see that the Sun does not rise and set on this day. The Sun’s path is tangential to the horizon, but never below it. This phenomenon is known as the midnight Sun, because the Sun is up at midnight (figure 21a and 21b).

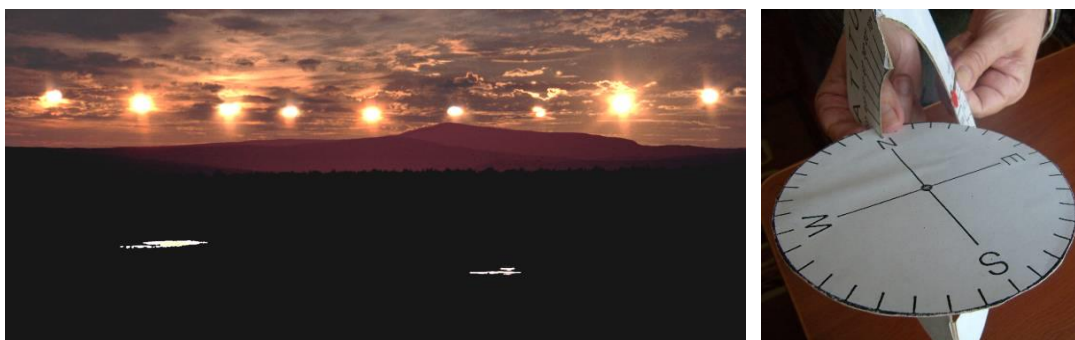

Fig. 21a and 21b: Path of the midnight Sun in Lapland (Finland). The Sun approaches the horizon but does not set. Rather, it begins to climb again (Photo: Sakari Ekko).

At the poles (90° N or 90° S) the Sun appears on the horizon for half a year and below the horizon for another half a year. It is very easy to illustrate this situation using the demonstrator (figure 22a and 22b).

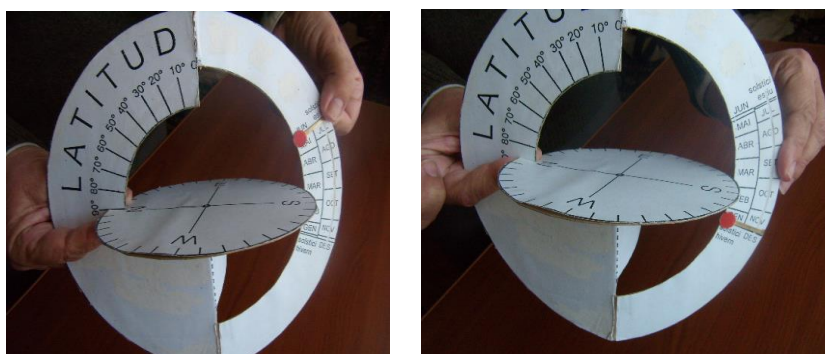

Fig. 22a and 22b: The demonstrator showing the Sun over the horizon for half a year and below the horizon for a half a year.

3. - Equatorial areas: THE SUN AT THE ZENITH

- *The Sun at the zenith*

In equatorial areas, the four seasons are not very distinct. The Sun's path is practically perpendicular to the horizon and the solar height is practically the same during the whole year. The length of the days is also very similar (figures 23a, 23b and 23c).

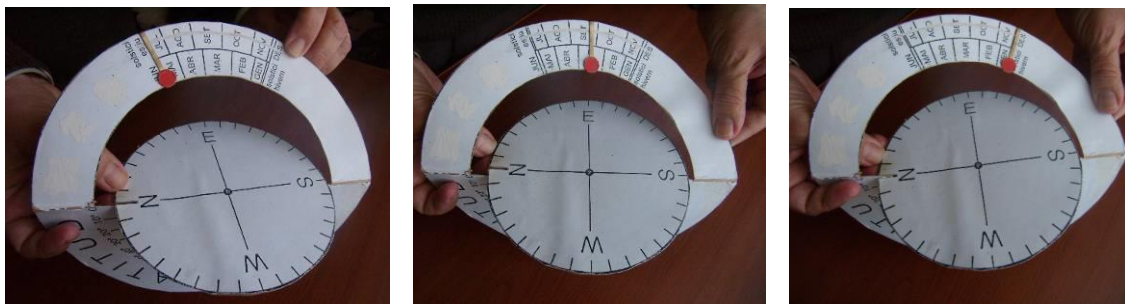

Fig. 23a, 23b and 23c: The Sun rises on the first day of each season: left - 1<sup>st</sup> day of summer, center - 1<sup>st</sup> day of spring or autumn, and right - 1<sup>st</sup> day of winter (in the Northern Hemisphere). On the equator the Sun's path is perpendicular to the horizon. The Sun rises at almost the same point every season. The angular distances between sunrises are only 23.5° (the ecliptic obliquity). In more extreme latitudes the Sun's path is more inclined and the distances between the three sunrise points increase (figures 17 and 19).

Moreover, in tropical countries there are some special days: the days when the Sun passes at the zenith. On these days, sunlight hits the Earth's surface at the equator perpendicularly. Because of this, the temperature is hotter and people's shadows disappear under their shoes (figure 24a). In some ancient cultures these days were considered to be very special because the phenomenon was very easy to observe. This is still the case now. In fact, there are two days per year when the Sun is at the zenith for those living between the Tropic of Cancer and the Tropic of Capricorn. We can illustrate this phenomenon using the demonstrator. It is also possible to approximately calculate the dates, which depend on the latitude (figure 24b).

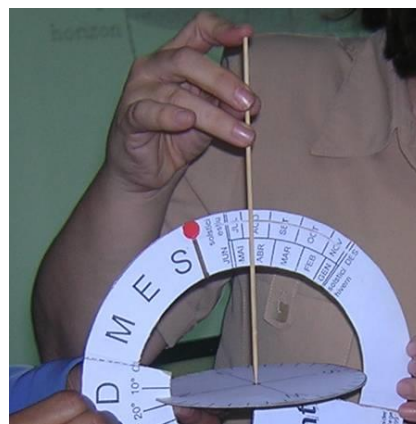

Fig. 24a: Small shadow (the Sun is almost at the zenith in a place near the equator). Fig. 24b: Simulating the Sun at the Zenith in Honduras (latitude 15° N).

For example (figure 24b), if we select a latitude of  $15^\circ$  N, using the demonstrator we can calculate approximately on what days the Sun is at the zenith at midday. It is only necessary to hold a stick perpendicular to the horizon disc and we see that these days are at the end of April and in the middle of August.

### XXL demonstrators

Naturally, the demonstrator can be made with other materials, for instance wood (figure 25a). In this case a light source can be introduced to show the Sun's position. With a camera, using a long exposure time, it is possible to visualize the Sun's path (figure 25b).



Fig. 25a: XXL wooden demonstrator. Fig. 25b: Stellar wooden demonstrator. Fig. 25c: With a camera it is possible to photograph the solar path using a large exposure time. (Photos: Sakari Ekko).

## Lunar demonstrator: why the Moon smiles in some places?

When teaching students about the Moon, we would like them to understand why the moon has phases. Also, students should understand how and why eclipses happen. Moon phases are very spectacular and it is easy to explain them by means of a ball and a light source.

Models such as those in figure 26 provide an image of the crescent Moon and sequential changes. There is a rule of thumb that says the crescent Moon is a "C" and waning as a "D". This is true for the inhabitants of the Southern Hemisphere, but it is useless in the northern hemisphere where they say that Luna is a "liar".

Our model will simulate the Moon's phases (figure 26), and will show why the moon looks like a "C" or a "D" depending on the phase. Many times, the Moon is observed at the horizon as shown in figure 27. However, depending on the country, it is possible to observe the Moon as an inclined "C", an inclined "D" (figure 28a) or in other cases as a "U" (called a "smiling Moon"; figure 28b). How can we explain this? We will use the lunar demonstrator to understand the varying appearance of the Moon's quarter at different latitudes.



Fig. 26: Moon phases.



Fig. 27: Moon phases observed at the horizon.

If we study the movements of the Moon, we must also consider its position relative to the Sun (which is the cause of its phases) and its declination (since it also changes every day, and more rapidly than the Sun.) We must therefore build a demonstrator that gives students the ability to easily change the position of the moon relative to the Sun and at a declination that varies considerably over a month. Indeed, as seen from Earth against the background stars, the Moon describes a trajectory in a month rather close to that of the Sun in one year, in line with the "ecliptic" (but tilted about  $5^\circ$  due to the inclination of its orbit).

The Moon is in the direction of the Sun when there is a "New Moon". When there is a "Full Moon", it is at a point opposite of the ecliptic, and its declination is opposite to that of the Sun (within 5 degrees north or south). For example, at the June solstice, the "Full Moon" is at the position where the Sun is during the December solstice; its declination is negative (between  $-18^\circ$  and  $-29^\circ$ ). The diurnal motion of the full moon in June is similar to that of the Sun in December.

If we consider the crescent-shaped "D" in the northern hemisphere (and "C" in the Southern), we know that the Moon is  $90^\circ$  relative to the Sun. However, it is "far" from the sun on the ecliptic path (about three months' difference). In June, the crescent moon will have a declination close to the declination of the Sun in September ( $0^\circ$ ). In the month of September, it will have a declination close to that of the Sun in December ( $-23.5^\circ$ ), etc...



Fig. 28a: Slanting crescent Moon, Fig. 28b: Smiling Moon.

### Making the demonstrator

The lunar demonstrator is made the same way as the solar demonstrator. As before, we need a model to simulate the observations from the Northern Hemisphere, and one for the Southern Hemisphere (figures 12 and 13 for the Northern Hemisphere and 12 and 14 for the Southern Hemisphere). It is also a good idea to build one that is two times larger for use by the teacher.

Facilities such as solar simulator on a waning moon (in the form of "C" for the northern hemisphere, or in the form of "D" for the southern hemisphere) in place of the sun and get a lunar simulator. According to the instructions below.

In order to put the Moon in the demonstrator, cut out figure 29b (quarter Moon) and glue two pieces of sticky tape on and under the cut-out of the Moon (blue half-dot). Place this transparent strip on the area of the demonstrator where the months are specified (figures 12 or 14 depending on the hemisphere). The idea is that it will be easy to move this strip up and down in this area in order to situate it on the month of choice.

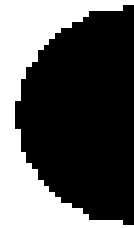

Fig. 29a: Using the demonstrator, Fig.29b: the Moon in the transparent strip Moon quarter.

### Uses of the lunar demonstrator

To use the demonstrator you have to select latitude. We will travel over the Earth's surface on an imaginary trip using the demonstrator.

Using your left hand, hold the main piece of the demonstrator (figure 30) by the blank area (below the latitude quadrant). Select the latitude and move the horizon disc until it shows the chosen latitude. Choose the day for which you want to simulate the movement of a waning moon. Add three months to that value and put the moon in the fourth phase (figure 29b). The month that the moon is facing is where the sun will be in three months. Use your right hand to move the disk that holds the moon from east to west.

With the simulator for the Northern Hemisphere, you can see that the appearance of the fourth quarter of the moon changes with the latitude and time of year. From the doll's perspective, the waning fourth quarter moon can appear as a "C" or a "U" on the horizon.

- If we select latitude around  $70^{\circ}$  N or  $70^{\circ}$  S we can see the quarter Moon as a "C" moving from East to West. The time of year does not matter. For all seasons the Moon looks like a "C" (figure 30a).
- If the latitude is  $20^{\circ}$  N or  $20^{\circ}$  S, the observer is close to the tropics, and we can see the quarter Moon smiling like a "U". The Moon moves following a line more perpendicular to the horizon than in the previous example (figure 30b). The "U" shape does not change with the month. It looks like this all year round.

- If the latitude is  $90^\circ$  N or  $90^\circ$  S, the observer is at the Poles, and depending on the day considered:
  - We can see the quarter Moon as a “C” moving on a path parallel to the horizon.
  - We can’t see it, because its trajectory is below the horizon.
- If the latitude is  $0^\circ$ , the observer is on the equator, and we can see the quarter Moon smiling as a “U”. The Moon rises and sets perpendicularly to the horizon. It will hide (at midday) in “U” shape, and will return like this: “∩”

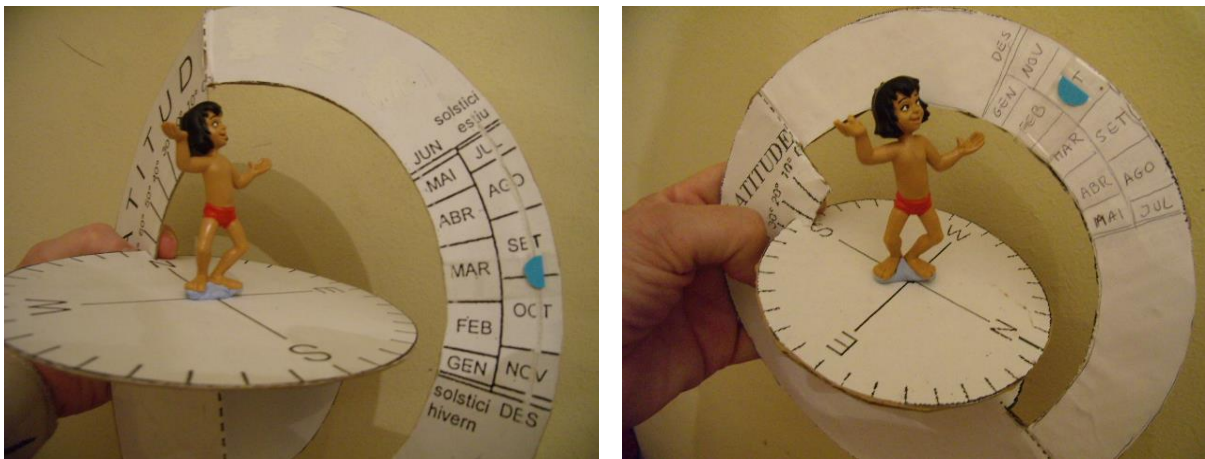

Fig. 30a: Demonstrator for latitude  $70^\circ$  N, Fig. 30b: latitude  $20^\circ$  S.

For other observers who live at intermediate latitudes, the quarter Moon rises and sets more or less at an angle, and has an intermediate shape between a “C” and a “U”.

The above comments apply similarly for the moon in a “D” shape. Again, we have to remember to correct the day (in this case we will have to take off three months) when we put in the position of the Sun.

- If we introduce a  $-70^\circ$  latitude (or  $70^\circ$  south) we can see the waning moon as a “D” that moves from east to west. This does not depend on the time of year. In all seasons the Moon appears as a “D” (figure 30a).
- If the latitude is  $-20^\circ$  (figure 30b) the observer is in the tropics and sees the Moon smiling like a “U”, possibly slightly tilted. The Moon moves in a trajectory perpendicular to the horizon unlike in the previous example (figure 30b). The shape of “U” does not change depending on the month.
- If the latitude is  $-90^\circ$ , the observer is at the South Pole and, according to the date, will be able to:
  - View the Moon as a “D” that moves in a path parallel to horizon.
  - Not see the Moon, because its path is below the horizon.



• At latitude  $0^\circ$ , as in the simulator of the Northern Hemisphere, the observer is at the Equator, and we can see the smile of the moon as a "U". The moon rises perpendicular to the horizon and it will hide (around noon) in a "U" and reappear as '∩'.

For other observers who live in middle latitudes, the phase of the Moon rises and sets in an intermediate position between a "D" and a "U", and is more or less inclined to match the latitude of observation.

These comments can be applied in a similar way to when the Moon appears as a "C", again subtracting three months from the Sun's position.

*“Acknowledgement: The authors wish to thank Joseph Snider for his solar device produced in 1992 which inspired her to produce other demonstrators.”*

## Bibliography

- Ros, R.M., *De l'intérieur et de l'extérieur*, Les Cahiers Clairaut, 95, 1, 5. Orsay, France, 2001.
- Ros, R.M., *Sunrise and sunset positions change every day*, Proceedings of 6th EAAE International Summer School, 177, 188, Barcelona, 2002.
- Ros, R.M., *Two steps in the stars' movements: a demonstrator and a local model of the celestial sphere*, Proceedings of 5th EAAE International Summer School, 181, 198, Barcelona, 2001.
- Snider, J.L., *The Universe at Your Fingertips*, Frankoi, A. Ed., Astronomical Society of the Pacific, San Francisco, 1995.
- Warland, W., *Solving Problems with Solar Motion Demonstrator*, Proceedings of 4th EAAE International Summer School, 117, 130, Barcelona, 2000.

# Earth-moon-sun system: Phases and eclipses

**Rosa M. Ros**

International Astronomical Union, Technical University of Catalonia (Barcelona, Spain)

## Summary

The following work deals with moon phases, solar eclipses, and lunar eclipses. These eclipses are also used to find distances and diameters in the Earth-Moon-Sun system.

Finally, a simple activity enables one to measure longitudes and heights along the moon's surface. The origin of tides is also explained.

## Goals

- To understand why the moon has phases.
- To understand the cause of lunar eclipses.
- To understand why solar eclipses occur.
- To determine distances and diameters of the Earth-Moon-Sun system.
- To understand the origin of the tides.

## Relative positions

The term “eclipse” is used for very different phenomena, but in all cases an eclipse takes place when one object crosses in front of another object; for this unit, the relative positions of the Earth and the Moon (opaque objects) cause the interruption of sunlight.

A solar eclipse happens when the Sun is covered by the Moon when it is located between the Sun and our planet. This kind of eclipse always takes place during new Moon (figure 1).

Lunar eclipses take place when the Moon crosses the shadow of the Earth. That is when the Moon is on the opposite side of the Sun, so lunar eclipses always occur at full moon phase (figure 1).

The Earth and the Moon move along elliptical orbits that are not in the same plane. The orbit of the Moon has an inclination of 5 degrees with respect to the ecliptic (plane of Earth's orbit around the sun). Both planes intersect on a line called the Line of Nodes. The eclipses take place when the Moon is near the Line of Nodes. If both planes coincided, the eclipses would be much more frequent than the zero to three times per year.

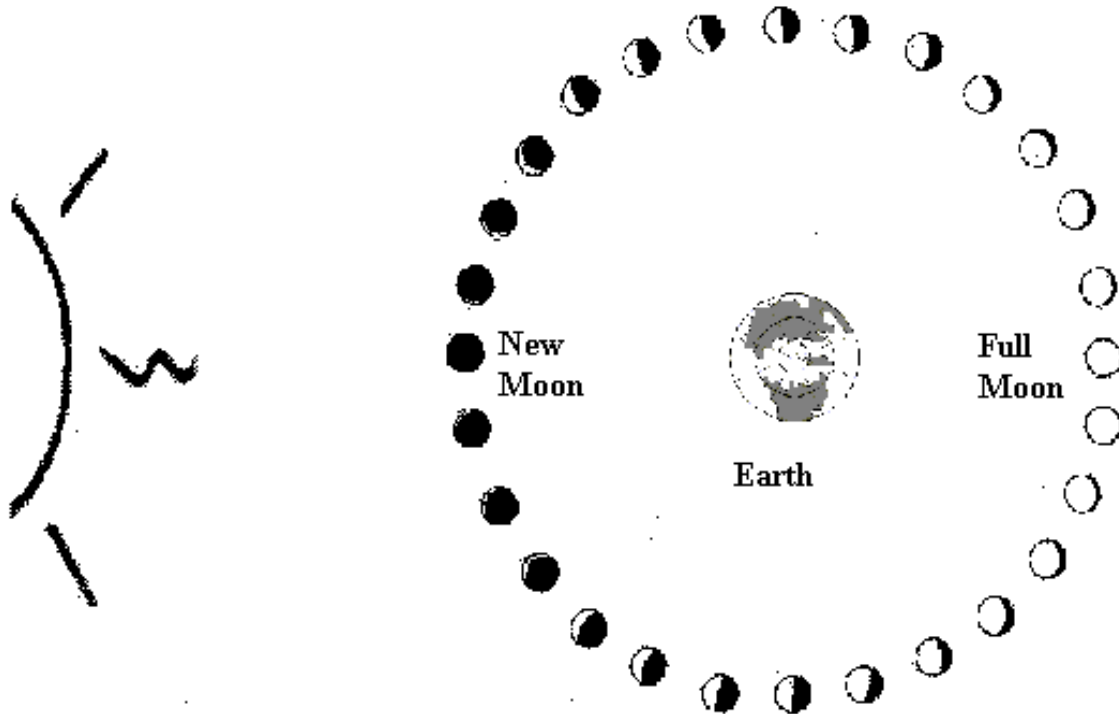

Fig.1: Solar eclipses take place when the Moon is located between the Sun and the Earth (new Moon). Lunar eclipses occur when the Moon crosses the shadow cone of the Earth (that is, the Earth is located between the Sun and the full Moon).

### Flashlight model

To explain the phases of the Moon it is best to use a model with a flashlight or with a projector (which will represent the Sun) and a minimum of 5 volunteers. One of them will be located in the center representing the Earth and the others will situate themselves around "the Earth" at equal distances to simulate different phases of the moon. To make it more attractive it is a good idea for each "moon" to wear a white mask that mimics the color of the moon. They should all face the "Earth". We will place the flashlight "sun" above and behind one of these volunteers, and begin to visualize the phases (as seen from the Earth, that is in the center). It is very easy to discover that sometimes the mask is completely lit, sometimes only a quarter and sometimes not at all (because the flashlight "sun" is behind that "moon" and its light dazzles the scene). The greater the number of volunteer "moons", the more phases can be seen.

This model is also used to visualize that we can only see one side of the Moon due to the rotation of the moon and translation around the Sun has the same duration. We begin by placing the volunteer who plays the role of Earth and only one "moon" volunteer. We place the "moon" volunteer in front of Earth before starting to move. So if the Moon moves 90 degrees in its orbit around the Earth, it also must turn 90 degrees on itself and therefore will continue looking in front of the Earth, and so on (figure 2).



Fig. 2: Earth-Moon model with volunteers (to explain the phases and the visible face of the Moon).

## Earth-Moon Model

It is not so easy to clearly understand the geometry underlying the phases of the moon, and solar and lunar eclipses. For that reason, a simple model is proposed in order to facilitate the understanding of all of these processes.

Insert two nails (about 3 or 4 cm) into a 125 cm. piece of wood. The nails should be separated by 120 cm. Two balls whose diameters are 4 and 1 cm should be placed on them (figure 3).

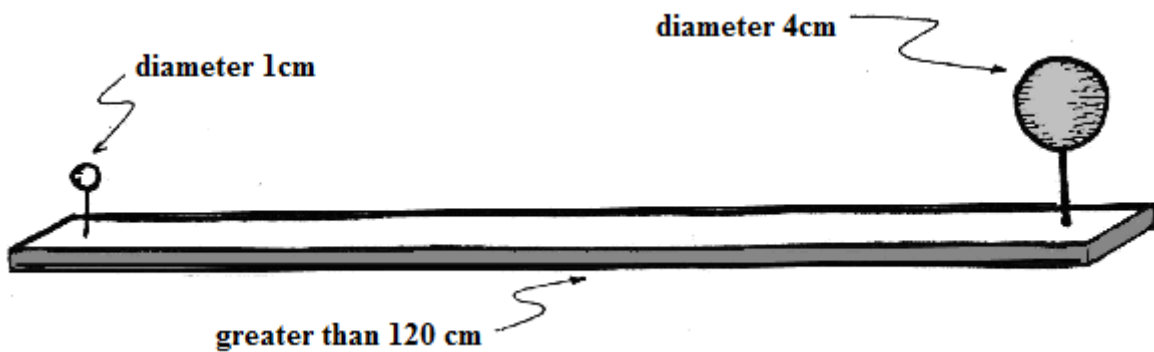

Fig. 3: Earth and Moon model.

It is important to maintain these relative sizes as they represent a scale model of the Earth-Moon system.

Earth diameter	12800 km.	→	4 cm.
Moon diameter	3500 km.	→	1 cm.
Earth-Moon distance	384000 km.	→	120 cm.
Sun diameter	1400000 km.	→	440 cm. = 4.4 m.
Earth-Sun distance	150000000 km.	→	4700 cm. = 0.47 Km.

Table 1: Distances and diameters of the Earth-Moon-Sun system.

### Reproduction of Moon phases:

In a sunny place, when the Moon is visible during the day, point the model towards the Moon guiding the small ball towards it (figure 4). The observer should stay behind the ball representing the Earth. The ball that represents the Moon will seem to be as big as the real Moon and the phase is also the same. By changing the orientation of the model the different phases of the Moon can be reproduced as the illumination received from the Sun varies. The Moon-ball has to be moved in order to achieve all of the phases.

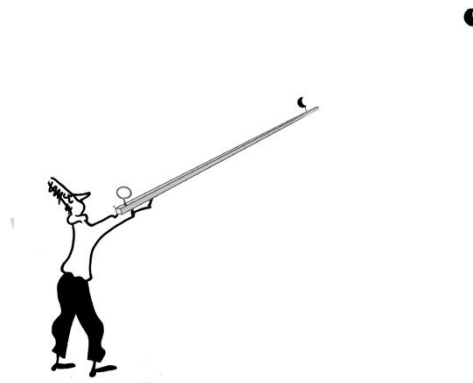

Fig.4: Using the model in the patio of the school.

It is better to do this activity outdoors, but, if it's cloudy, it can also be done indoors with the aid of a projector as a light source.

### Reproduction of Lunar eclipses

The model is held so that the small ball of the Earth is facing the Sun (it is better to use a projector to or a flashlight avoid looking at the Sun) and the shadow of the Earth covers the Moon (figure 5a and 5b) as it is larger than the Moon. This is an easy way of reproducing a lunar eclipse.

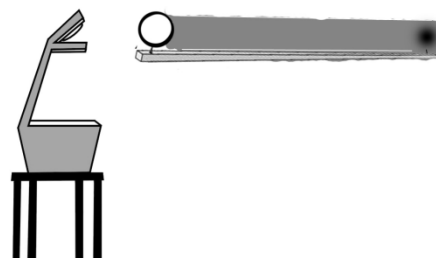

Fig.5a and 5b: Lunar eclipse simulation.



Fig. 6: Photographic composition of a lunar eclipse. Our satellite crosses the shadow cone produced by the Earth.

### Reproducing the eclipses of the Sun

The model is placed so that the ball of the Moon faces the Sun (it is better to use the projector or the flashlight) and the shadow of the Moon has to be projected on the small Earth ball. By doing this, a solar eclipse will be reproduced and a small spot will appear over a region of the Earth (figure 7a and 7b).

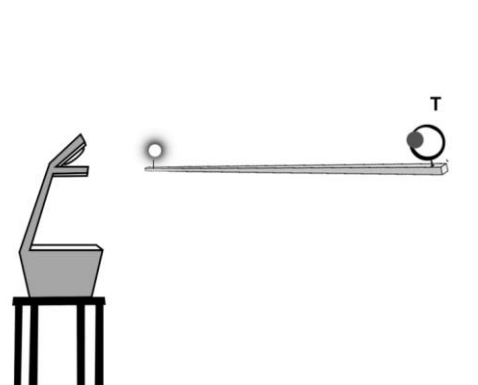

Fig. 7a and 7b Solar eclipse simulation

It is not easy to produce this situation because the inclination of the model has to be finely adjusted (that is the reason why there are fewer solar than lunar eclipses).



Fig.8: Detail of the previous figure 5a.



Fig. 9: Photograph taken from the ISS of the solar eclipse in 1999 over a region of the Earth's surface.

### ***Observations***

- A lunar eclipse can only take place when it is full Moon and a solar eclipse when it is new Moon.
- A solar eclipse can only be seen on a small region of the Earth's surface.
- It is rare that the Earth and the Moon are aligned precisely enough to produce an eclipse, and so it does not occur every new or full Moon.

## Model Sun-Moon

In order to visualize the Sun-Earth-Moon system with special emphasis on distances, we will consider a new model taking into account the terrestrial point of view of the Sun and the Moon. In this case we will invite the students to draw and paint a big Sun of 220 cm diameter (more than 2 meters diameter) on a sheet and we will show them that they can cover this with a small Moon of 0.6 cm diameter (less than 1 cm diameter).

It is helpful to substitute the Moon ball for a hole in a wooden board in order to be sure about the position of the Moon and the observer.

In this model, the Sun will be fixed 235 meters away from the Moon and the observer will be at 60 cm from the Moon. The students feel very surprised that they can cover the big Sun with this small Moon. This relationship of 400 times the sizes and distances is not easy to imagine so it is good to show them with an example in order to understand the scale of distances and the real sizes in the universe.

All these exercises and activities help them (and maybe us) to understand the spatial relationships between celestial bodies during a solar eclipse. This method is much better than reading a series of numbers in a book.

Earth Diameter	12 800 km	2.1 cm
Moon Diameter	3 500 km	0.6 cm
Distance Earth-Moon	384 000 km	60 cm
Sun Diameter	1400 000 km	220 cm
Distance Earth-Sun	150 000 000 km	235 m

Table 2: Distances and diameters of system Earth-Moon-Sun



Fig. 10: Sun model, Fig. 11: Observing the Sun through the Moon's hole.



## Measuring the Sun’s diameter

We can measure the Sun’s diameter in different ways. Here we present a simple method using a pinhole camera. We can do it with a shoebox or a cardboard tube that serves as a central axis for aluminum foil or plastic wrap.

1. We covered one end with semi-transparent vellum graph paper and the other end with a strong piece of paper or aluminum foil, where we will make a hole with a thin pin (figures 12 and 13).
2. We must point the end with the small hole towards the Sun and look towards the other end which is covered by the graph paper. We measure the diameter,  $d$ , of the image of the Sun on this graph paper.



Fig. 12 and 13: Model of the pinhole camera.

To calculate the diameter of the Sun, just consider figure 14, where we show two similar triangles.

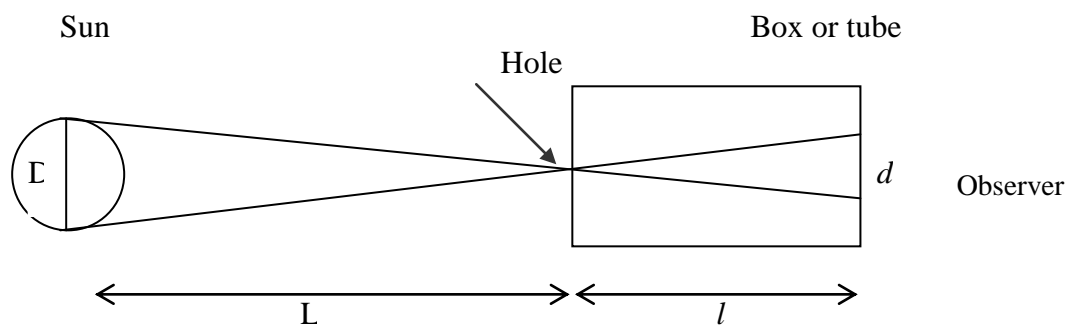

Fig. 14: Underlying geometry of calculation.

Here we can establish the relationship:

$$\frac{D}{L} = \frac{d}{l}$$

And can solve for the diameter of the Sun,  $D$ :

$$D = \frac{d \cdot L}{l}$$

Knowing the distance from the Sun to the Earth  $L = 150,000,000$  km the tube's length  $l$  and the diameter  $d$  of the Sun's image over the screen of the graph semi-transparent paper, we can calculate the diameter  $D$  of the Sun. (The answer should be about 1,392,000 km.)

We can repeat the exercise with the Full Moon knowing that it is 400,000 km away from the Earth.

## Sizes and Distances in the Earth-moon-sun system

Aristarchus (310 to 230 BC) deduced the proportion between the distances and radii of the Earth-Moon-Sun system. He calculated the radius of the Sun and Moon, the distance from the Earth to the Sun and the distance from the Earth to the Moon in relation to the radius of the Earth. Some years afterwards, Eratosthenes (280-192 BC) determined the radius of our planet and it was possible to calculate all the distances and radii of the Earth-Moon-Sun system.

The proposal of this activity is to repeat both experiments as a student activity. The idea is to repeat the mathematical process and, as closely as possible, the observations designed by Aristarchus and Eratosthenes.

### Aristarchus's experiment

#### *Relationship between the Earth-Moon and Earth-Sun distances*

Aristarchus determined that the angle between the Moon-Sun line and the Earth-Sun line when the moon is in quarter phase is  $\alpha = 87^\circ$  (figure 15).

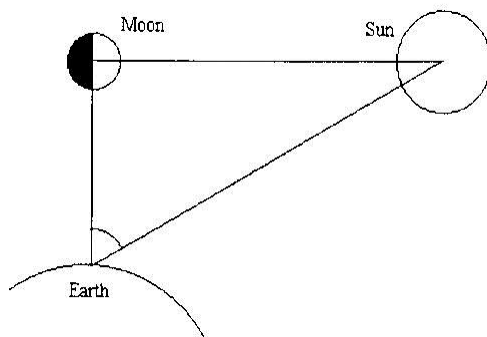

Fig. 15: Relative position of the Moon in quarter phase.

Nowadays we know that he was slightly wrong, possibly because it was very difficult to determine the precise timing of the quarter moon. In fact this angle is  $\alpha = 89^\circ 51'$ , but the

process used by Aristarchus is perfectly correct. In figure 15, if we use the definition of secant, we can deduce that

$$\cos \alpha = ES/EM$$

where ES is the distance from the Earth to the Sun, and EM is the distance from the Earth to the moon. Then approximately,

$$ES = 400 EM$$

(although Aristarchus deduced  $ES = 19 EM$ ).

*Relationship between the radius of the Moon and the Sun*

The relationship between the diameter of the Moon and the Sun should be similar to the formula previously obtained, because from the Earth we observe both diameters as 0.5 °. So both ratios verify

$$R_S = 400 R_M$$

*Relationship between the distance from the Earth to the Moon and the lunar radius or between the distance from the Earth to the Sun and the solar radius*

Since the observed diameter of the Moon is 0.5 degrees, the circular path (360°) of the Moon around the Earth would be 720 times the diameter. The length of this path is 2π times the Earth-Moon distance, i.e.  $2 R_M 720 = 2 \pi EM$ . Solving, we find

$$EM = (720 R_M)/\pi$$

Using similar reasoning, we find

$$ES = (720 R_S)/\pi$$

This relationship is between the distances to the Earth, the lunar radius, the solar radius and the terrestrial radius.

During a lunar eclipse, Aristarchus observed that the time required for the moon to cross the Earth's shadow cone was twice the time required for the moon's surface to be covered (figure 16). Therefore, he concluded that the shadow of the Earth's diameter was twice the diameter of the moon, that is, the ratio of both diameters or radius was 2:1. Today, it is known that this value is 2.6:1.

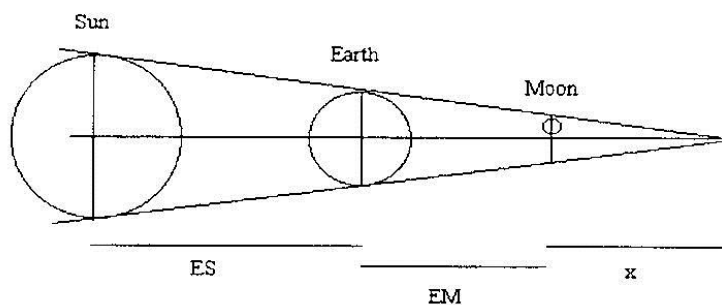

Fig. 16: Shadow cone and relative positions of the Earth-Moon-Sun system.

Then, (figure 16) we deduce the following relationship:

$$x / (2.6 R_M) = (x+EM) / R_E = (x+EM+ES) / R_S$$

where x is an extra variable. Introducing into this expression the relationships  $ES = 400 EM$  and  $R_S = 400 R_M$ , we can delete x and after simplifying we obtain,

$$R_M = (401/1440) R_E$$

This allows us to express all the sizes mentioned previously as a function of the Earth's radius, so

$$R_S = (2005 / 18) R_E, ES = (80200 / \pi) R_E, EM = (401 / (2\pi)) R_E$$

where we only have to substitute the radius of our planet to obtain all the distances and radii of the Earth-Moon-Sun system.

**Measurements with students**

It's a good idea to repeat the measurements made by Aristarchus with students. In particular, we first have to calculate the angle between the Sun and the quarter moon. To make this measurement it is only necessary to have a theodolite and know the exact timing of the quarter moon.

So we will try to verify if this angle measures  $\alpha = 87^\circ$  or  $\alpha = 89^\circ 51'$  (although this precision is very difficult to obtain).

Secondly, during a lunar eclipse, using a stopwatch, it is possible to calculate the relationship between the following times: "the first and last contact of the Moon with the Earth's shadow cone", i.e., measure the diameter of the Earth's shadow cone (figure 17a) and "the time necessary to cover the lunar surface," that is a measure of the diameter of the moon (figure 20b). Finally, it is possible to verify if the ratio between both is 2:1 or is 2.6:1.

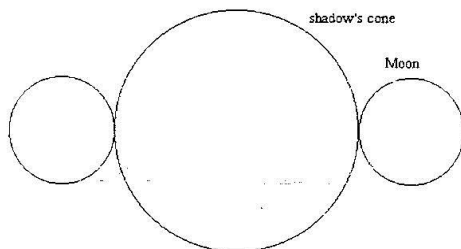

Fig. 17a: Measuring the cone of shadow.

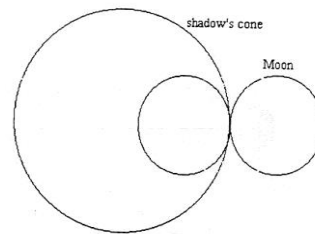

Fig.17b: Measuring the diameter of the moon.

The most important objective of this activity is not the result obtained for each radius or distance. The most important thing is to point out to students that if they use their knowledge and intelligence, they can get interesting results with few resources. In this case, the ingenuity of Aristarchus was very important to get some idea about the size of the Earth-Moon-Sun system.

It is also a good idea to measure with the students the radius of the Earth following the process used by Eratosthenes. Although the experiment of Eratosthenes is well known, we present here a short version of it in order to complete the previous experience.

*Eratosthenes' experiment, again*

Consider two stakes placed perpendicular to the ground, in two cities on the Earth's surface on the same meridian. The stakes should be pointing toward the center of the Earth. It is usually better to use a plumb where we mark a point of the wire to measure lengths. We should measure the length of the plumb from the ground to the mark, and the length of its shadow from the base of the plumb to the shadow of the mark.

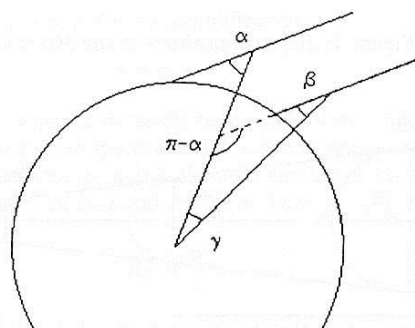

Fig. 18: Placement of plumbs and angles in the Eratosthenes experiment.

We assume that the solar rays are parallel. The solar rays produce two shadows, one for each plumb. We measure the lengths of the plumb and its shadow and using the tangent definition, we obtain the angles  $\alpha$  and  $\beta$  (figure 18). The central angle  $\gamma$  can be calculated imposing that the sum of the three angles of the triangle is equal to  $\pi$  radians. Then  $\pi = \pi - \alpha + \beta + \gamma$  and simplifying

$$\gamma = \alpha - \beta$$

where  $\alpha$  and  $\beta$  have been obtained by the plumb and its shadow.

Finally establishing a proportionality between the angle  $\gamma$ , the length of its arc  $d$  (determined by the distance above the meridian between the two cities), and  $2\pi$  radians of the meridian circle and its length  $2\pi R_E$ , we find:

$$\gamma/d = 360/(2\pi R_E)$$

Then we deduce that:

$$R_E = d/\gamma$$

where  $\gamma$  has been obtained by the observation and  $d$  is the distance in km between both cities. We can find  $d$  from a good map.

It should also be mentioned that the purpose of this activity is not the accuracy of the results. Instead, we want students to discover that thinking and using all of the possibilities you can imagine can produce surprising results.

## Tides

Tides are the rise and fall of sea level caused by the combined effects of Earth's rotation and gravitational forces exerted by the Moon and the Sun. The shape of the sea bottom and shore in the coastal zone also influence the tides, but to a lesser extent. Tides are produced with a period of approximately 12 ½ hours.

The tides are mainly due to the attraction between the Moon and Earth. High tides occur on the sides of the Earth facing the moon and opposite the moon (figure 19). Low tides occur in the intermediate points.

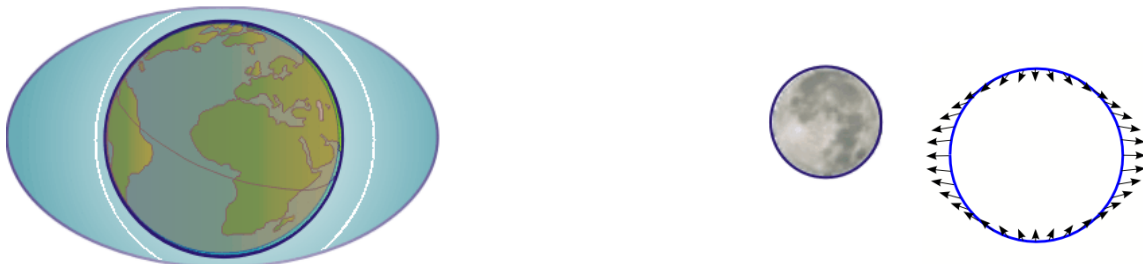

Fig. 19: Tide’s effect. Fig. 20: Effect on water of the differential relative acceleration of the Earth in different areas of the ocean.

Tidal phenomena were already known in antiquity, but their explanation was only possible after the discover of Newton’s law of the Universal Gravitation (1687).

$$F_g = G \frac{m_T \times m_L}{d^2}$$

The moon exerts a gravitational force on Earth. When there is a gravitational force, there is a gravitational acceleration according to Newton's second law ( $F = m a$ ). Thus, the acceleration caused by the moon on Earth is given by

$$a_g = G \frac{m_L}{d^2}$$

Where  $m_l$  is the moon mass and  $d$  is the distance from the moon to a point on the Earth.

The solid part of Earth is a rigid body and, therefore, we can consider all the acceleration on this solid part applied to the center of the Earth. However, water is liquid and undergoes a distinct acceleration that depends on the distance to the moon. So the acceleration of the side closest to the moon is greater than the far side. Consequently, the ocean's surface will generate an ellipsoid (figure 20).

That ellipsoid is always extended towards the Moon (figure 19) and the Earth will turn below. Thus every point on Earth will have a high tide followed by low tide twice per day. Indeed the period between tides is a little over 12 hours and the reason is that the moon rotates around the Earth with a synodic period of about 29.5 days. This means that it runs 360° in 29.5 days, so the moon will move in the sky nearly 12.2° every day or 6.6° every 12 hours. Since each hour the Earth itself rotates about 15°, 6.6° is equivalent to about 24 minutes, so each tidal

cycle is 12 hours and 24 minutes. As the time interval between high tide and low tide is about half this, the time it take for high tides to become low tides, and vice versa, will be about 6 hours 12 min.

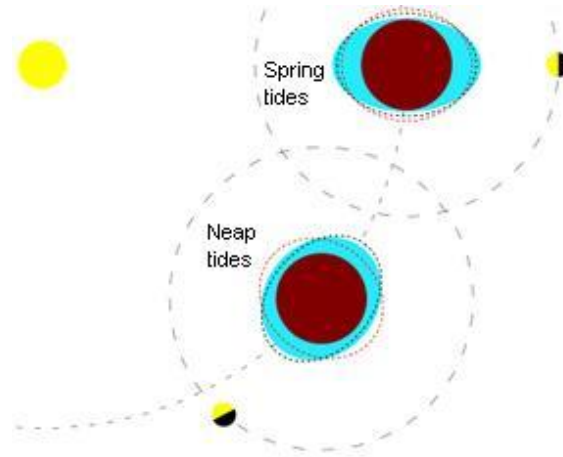

Fig. 21: Spring tides and neap tides.

Due to its proximity, the Moon has the strongest influence on the tides. But the Sun also has influence on the tides. When the Moon and Sun are in conjunction (New Moon) or opposition (Full Moon) spring tides occur. When the Moon and the Sun exercise perpendicular gravitational attraction (First Quarter and Last Quarter), the Earth experiences neap tides (figure 24).

## Bibliography

- Alonso, M., Finn, E. *Física – un curso universitario*. Volume I. Ed. Edgard Blucher, 1972
- Broman, L., Estalella, R., Ros, R.M., *Experimentos de Astronomía. 27 pasos hacia el Universo*, Editorial Alambra, Madrid, 1988.
- Broman, L., Estalella, R., Ros, R.M., *Experimentos de Astronomía*, Editorial Alambra, Mexico, 1997.
- Fucili, L., García, B., Casali, G., “A scale model to study solar eclipses”, *Proceedings of 3rd EAAE Summer School*, 107, 109, Barcelona, 1999
- Reddy, M. P. M., Affholder, M. *Descriptive physical oceanography: State of the Art*. Taylor and Francis. 249, 2001.
- Ros, R.M., Lunar eclipses: Viewing and Calculating Activities, *Proceedings of 9<sup>th</sup> EAAE International Summer School*, 135, 149, Barcelona, 2005.
- Ros, R.M., Viñuales, E., Aristarchos’ Proportions, *Proceedings of 3<sup>rd</sup> EAAE International Summer School*, 55, 64, Barcelona, 1999.
- Ros, R.M., Viñuales, E., El mundo a través de los astrónomos alejandrinos, *Astronomía, Astrofotografía y Astronáutica*, 63, 21. Lérida, 1993.

# Young Astronomer Briefcase

**Rosa M. Ros**

International Astronomical Union, Technical University of Catalonia (Barcelona, Spain)

## Summary

To further observation it is necessary that students have a set of simple tools. It is proposed that they construct some of them and then use them in observing the sky from the school itself.

Students should understand in a basic way how various instruments have been introduced over the centuries, how they have developed, and have become necessary. It is an important part of astronomy, noting the great ability to build them and the skill to use them to do readings of the observations. These requirements are not easy to develop with students and for that reason here we propose very simple instruments.

## Goals

- Understand the importance of making careful observations.
- Understand the use of various instruments thanks to the fact that students do the construction by themselves.

## The Observations

We can acquire some practice in the measurement of time and positions of celestial bodies with prepared artifacts "ad hoc". Here we give some information to gather a collection of tools for observation in a suitcase. The suitcase and contents are generally made of cardboard using glue, scissors, etc.. The topic may offer the possibility to investigate many other ancient and modern instruments.

The artistic and imaginative ability of students will allow very personal suitcases. This activity can be easily modified and adapted to the students depending on their age, with more or less sophisticated tools.

In particular, this suitcase contains:

- A ruler for measuring angles
- A simplified quadrant
- A horizontal goniometer
- A planisphere



- A map of the Moon
- An equatorial clock
- A spectroscope

We propose a suitcase with very simple tools. The small suitcase can be easily taken to school or during free time, ready for use. It is important this is not too large or fragile (especially if it is to be used by very young students). We emphasize that exactness in the measurements is not the end of this activity.

## Contents

We obviously can only simulate this on a schoolyard in the summer. The idea is to get practice with the tools that we will do here now.

First, we need a cardboard box like the ones you receive by mail with a book inside (this will be the suitcase). It is necessary only to place a handle on the narrow side and that the wide side could be opened. Inside the box, we will post the following instruments:

- ❖ A "**ruler to measure angles**" that can be used to give us the angular distance between two stars of that constellation. It is very easy to use if we don't want to introduce the coordinates.
- ❖ A **simplified quadrant** can be used to obtain the height of the stars. When students see an object through the viewfinder the string indicates the angular position related to its horizon.
- ❖ A simple **horizontal goniometer** can be used to determine the azimuth of the stars. Obviously you need to use a compass to orient the instrument in the North-South direction.
- ❖ A **planisphere** with the constellations photocopied very clearly onto a disc of white paper and a cardboard pocket with the "hole" of the latitude to put the disk of the sky inside. Turning the disc we find the date and time of observation to recognize the major constellations at the latitude of the "hole" that we use.
- ❖ A **spectroscope** to separate light into the seven colors that compose it.
- ❖ A **map of the Moon** with the names of seas and some craters that are easily recognizable through binoculars.
- ❖ A **flashlight** (red light) to illuminate the maps before looking at the real sky. Bright white light will make it difficult for the students' eyes to adjust to the darkness. If students bring a flashlight in their suitcase, you need to put a red filter on the front. A group of students with white flashlights can produce a lot of light pollution making the observations more difficult.
- ❖ A **compass** for aligning the different instruments.
- ❖ And of course all the accessories that needs every student: notebook, pen, a watch and, if it is possible, a camera

Following the instructions and drawings we can get our tools in a very simple way and use them outdoors. During the day we'll measure, for example, with the quadrant the position

(angular height) of a tree, a hill, and so on. At night, we can measure the position of two different stars or the Moon in order to understand the periodic cycle of its phases. We encourage students to take data.

For the first nighttime observations it is better to use simple maps prepared in advance to become familiar with the most important constellations. Of course the astronomical maps are very accurate but the experience of teachers suggests that sometimes, without assistance, they are initially confusing.

### A ruler to measure angles

Considering a simple proportion we can build a basic instrument for measuring angles in any situation. Our main aim is to answer the following question: "What is the distance (radius R) that I need in order to obtain a device that 1° is equivalent to 1 cm?".

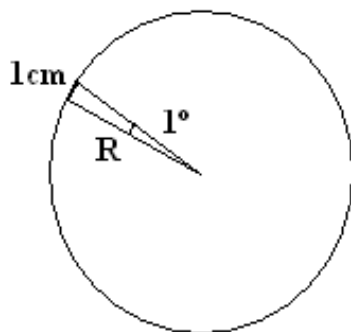

Fig. 1: The radius R in order to obtain an instrument where 1° is equivalent to 1 cm.

In figure 1 we consider the relationship between the circumference of length  $2 \pi R$  in centimeters to 360 degrees, with 1 cm to 1°:

$$\frac{2\pi R \text{ cm}}{360^\circ} = \frac{1 \text{ cm}}{1^\circ}$$

So,

$$R = 180 / \pi = 57 \text{ cm}$$

**To build the instrument:** We take a ruler, where we fix a string of 57 cm of length. It is very important that the string doesn't stretch.

**How we use it:**

- We watched with the end of the string almost touching our eye "on the cheek, under the eye"
- We can measure using the rule and the equivalence is 1 cm = 1 degree if the string is extended (figure 2)

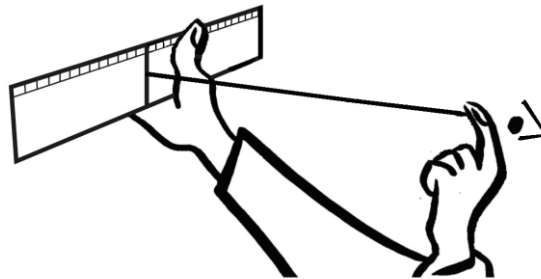

Fig. 2: Using the instrument (a ruler and a piece of string 57 cm long), we can measure angles with the equivalence “1cm = 1°”.

**Proposed exercises:**

**What is the angular distance between two stars of the same constellation?** Use the "ruler to measure angles" to compute the distance (in degrees) between Merak and Dubne of Ursa Major.

**A simplified quadrant: quadrant "gun"**

A very simplified version of the quadrant can be very useful for measuring angles. Here we present the "gun" version that is user friendly which encourages their use by students.

**To build it:** You need a rectangular piece of cardboard (about 12x20cm). We cut out a rectangular area as in figure 3 in order to hold the instrument. We place two round hooks on the side (figure 3).

In a paper quadrant (figure 4) with the stick angles shown (figure 3) so that one of the hooks is on the position 0° (figure 3). Tie a string on the top and at the other end attach a small weight.

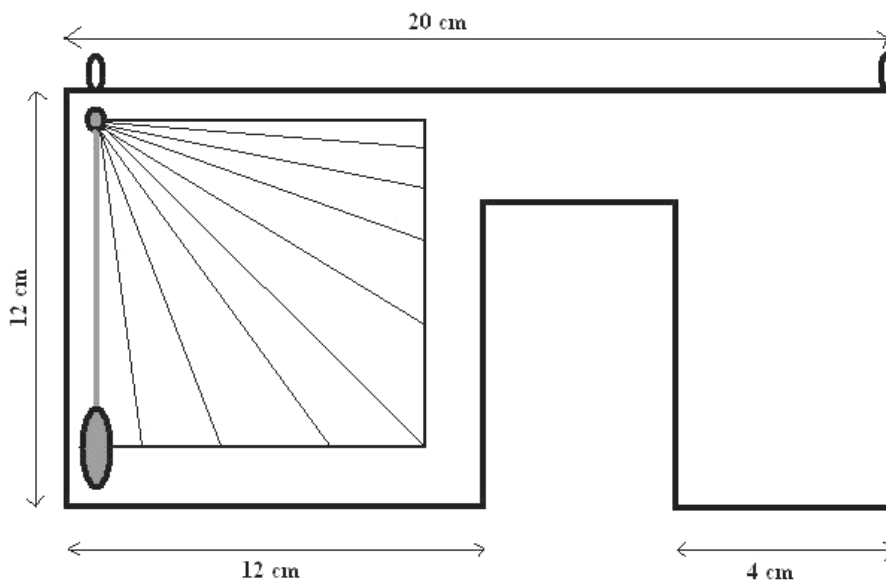

Fig. 3: Quadrant “Gun”.

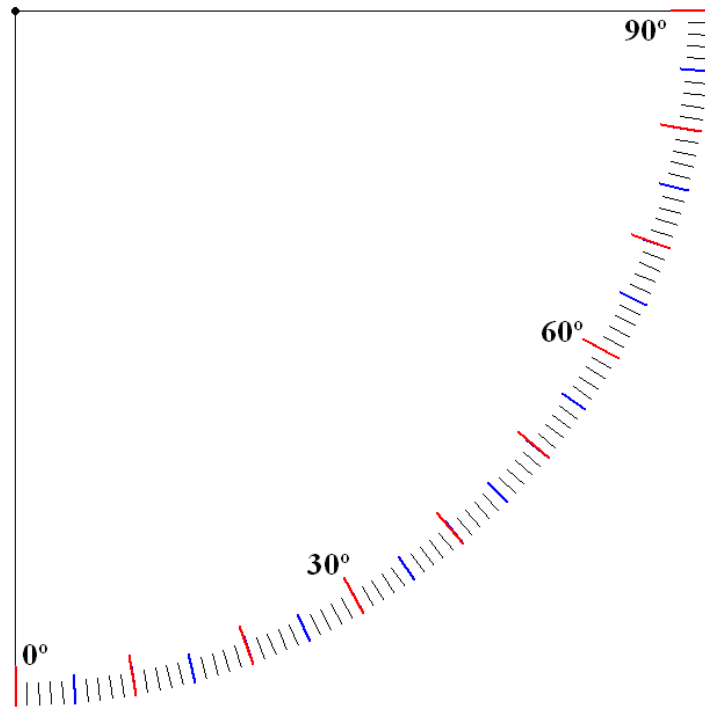

Fig. 4: Graduation of 90 ° to stick on the quadrant.

**How to use it?:**

- When viewing the object through the two hooks the string indicates the angular position 0 ° refers to the horizon (figure 5b).
- A straw passing through the hooks is an excellent viewer that will allow us to measure the height of the Sun by projecting the image onto a piece of white cardboard. CAUTION: DO NOT EVER LOOK DIRECTLY AT THE SUN!!!

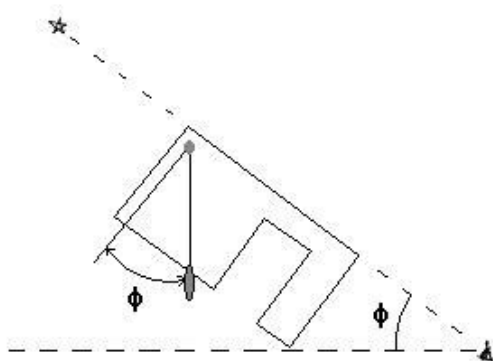

Fig. 5a and 5b: Using a “gun” style quadrant.

**Exercises proposed:**

**What is the latitude of the school?**

We will use the quadrant to measure the height of Polaris. The latitude of a place is equal to the height of the Pole at that place (figure 6).

You can also use the quadrant to compute (in math class) the height of the school or another nearby building.

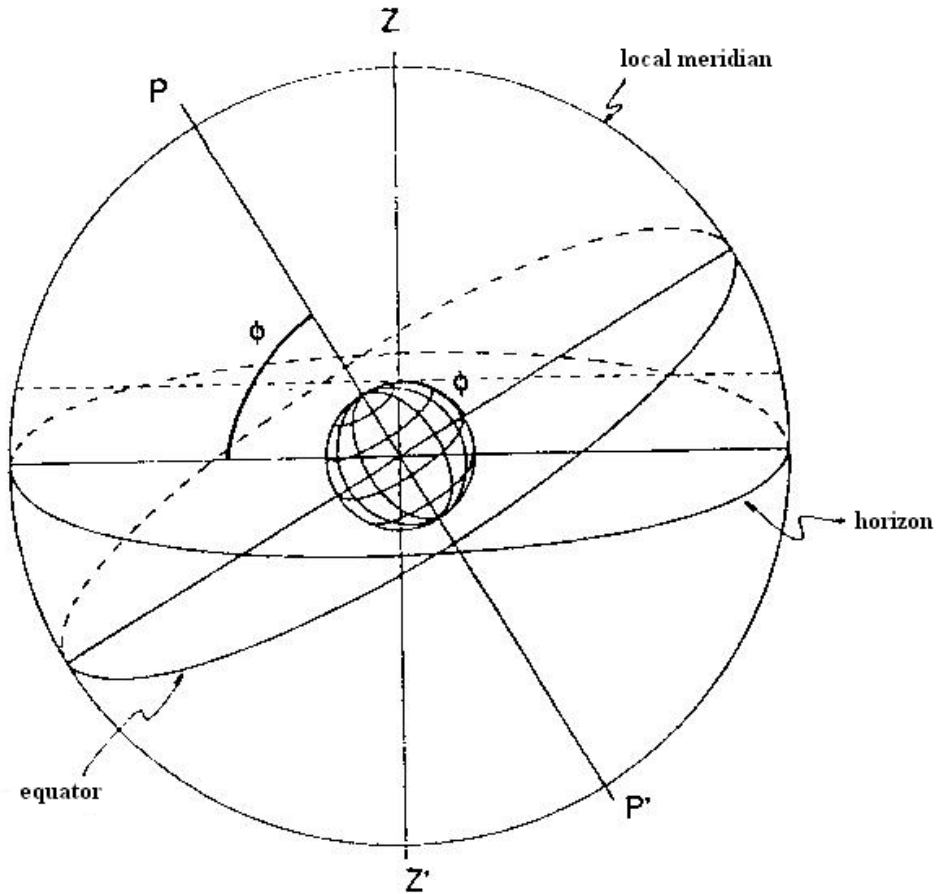

Fig. 6: The latitude of the place  $\phi$  is equal to the height of the pole.

**Horizontal Goniometer**

A simplified version of horizontal goniometer can be used to know the second coordinate needed to determine the position of a celestial body.

**To build the tool:** Cut a cardboard rectangle about 12x20cm (figure 7a). We stick a semicircle of paper (figure 8) with the angles indicated so that the diameter of the semicircle is parallel to the longest side of the rectangle. Using 3 "needles" we can mark two directions in the goniometer (figure 7b).

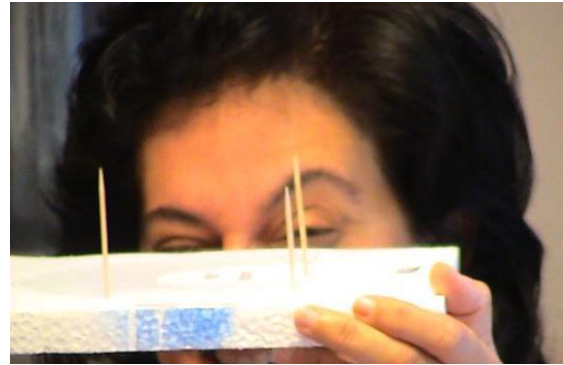
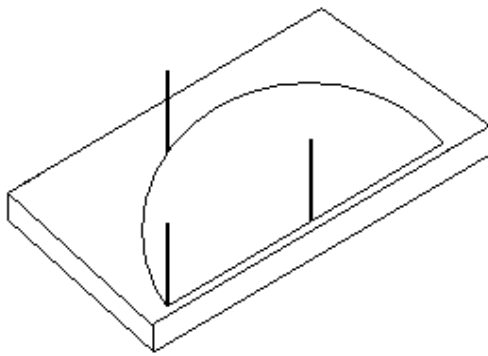

Fig. 7a and 7b: Using the horizontal goniometer.

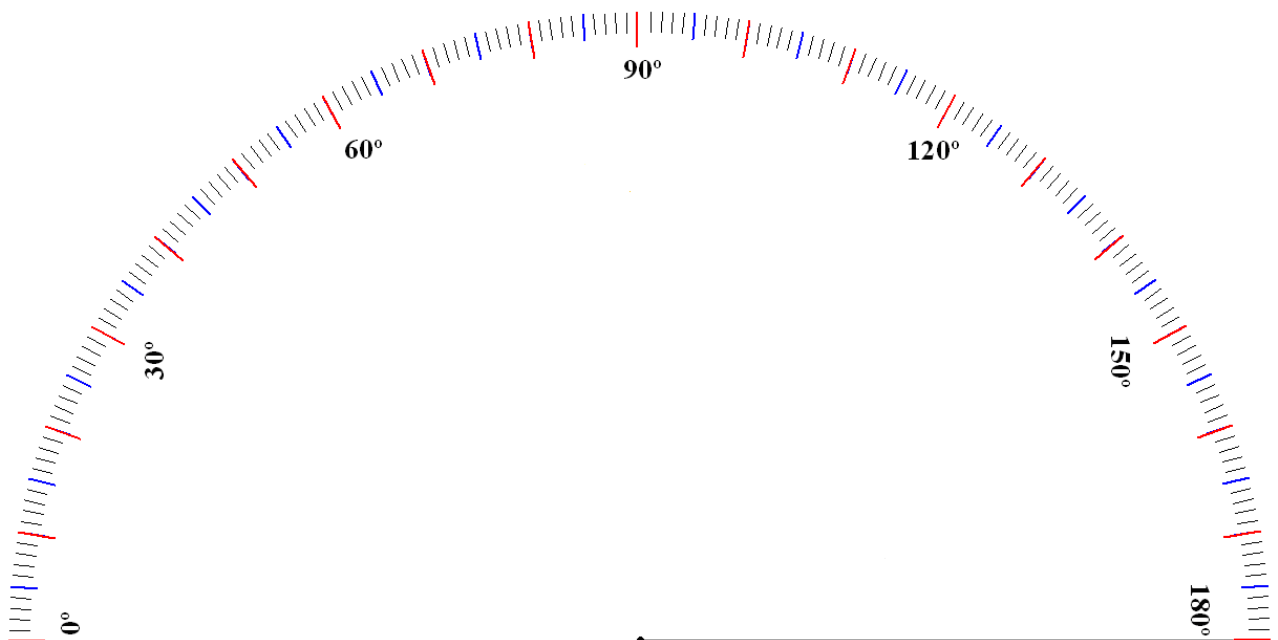

Fig. 8: Graduation of 180° to stick on the horizontal goniometer.

**How is it used:**

- If we want to measure the azimuth of a star we align the starting line of the semicircle in the North-South direction.
- The azimuth is the angle between the North-South line and the line through the center of the circle and the direction of the body.

**Proposed exercises:**

**What is the position of the moon tonight?**

*Use the quadrant and the horizontal goniometer to calculate the height and azimuth of the moon. To study the motion of the moon at night, you can determine the two coordinates three times every hour. This way you can compare the motion of the moon with the stars in the sky.*

## The planisphere

We use star maps -which depend on the latitude- to recognize the constellations. We build one of them but we recommend extending it with a photocopier.

**To build the planisphere:** We will use a photocopy of the constellations of the sky in a "white" disc and will place into a holder depending on your latitude close to the equator.

### *Northern Hemisphere*

For places in the northern hemisphere with *latitudes between 0 and 20 degrees* you should prepare two planispheres, one for each horizon. To build the northern horizon we cut the window of figure 9a by the continuous line corresponding latitude and fold it on the dotted line to form a pocket. We will place the star map of figure 10a inside. Now we have the planisphere of the northern horizon. We proceed analogously to build the planisphere of the southern horizon. Cutting and bending, as before, the window of figure 9b in placing inside the star map in figure 10a. We will use both planispheres as we are looking towards the horizon north or south.

When we wish to observe in the northern hemisphere with *latitudes between 30 and 70 degrees* it is enough to cut the window in figure 9e by the solid line and fold the dotted line to get a pocket where it will place the circle of stars that we cut above (figure 10a).

### *Southern Hemisphere*

For places in the southern hemisphere with *latitudes between 0 and 20 degrees* we should prepare two planispheres, one for each horizon. At first we build the northern horizon. We cut the window of figure 9c by the continuous line corresponding latitude and fold it by the dotted line to form a pocket. We will place the star map of figure 10b inside. With this operation we have the planisphere of the northern horizon. We proceed analogously to build the planisphere of the southern horizon. Cutting and bending, as before, the window of figure 9d in placing inside the star map in figure 10b. We will use both planispheres as we are looking towards the horizon north or south.

When we wish to see in the southern hemisphere with *latitudes between 30 and 70 degrees* it is enough to cut the window in Figure 9f by the solid line and fold the dotted line to get a pocket where it will place the circle of stars that we cut above (figure 10b).

### **How to use:**

- Place the date of the day when we will look in line with the observation time by rotating the circle of stars and use the world map looking at the sky in the direction indicated. The part of the sky that is visible in the sky is shown.
- Note: A planisphere is used as an umbrella. It is a map of the sky and you place it above your head to recognize constellations.

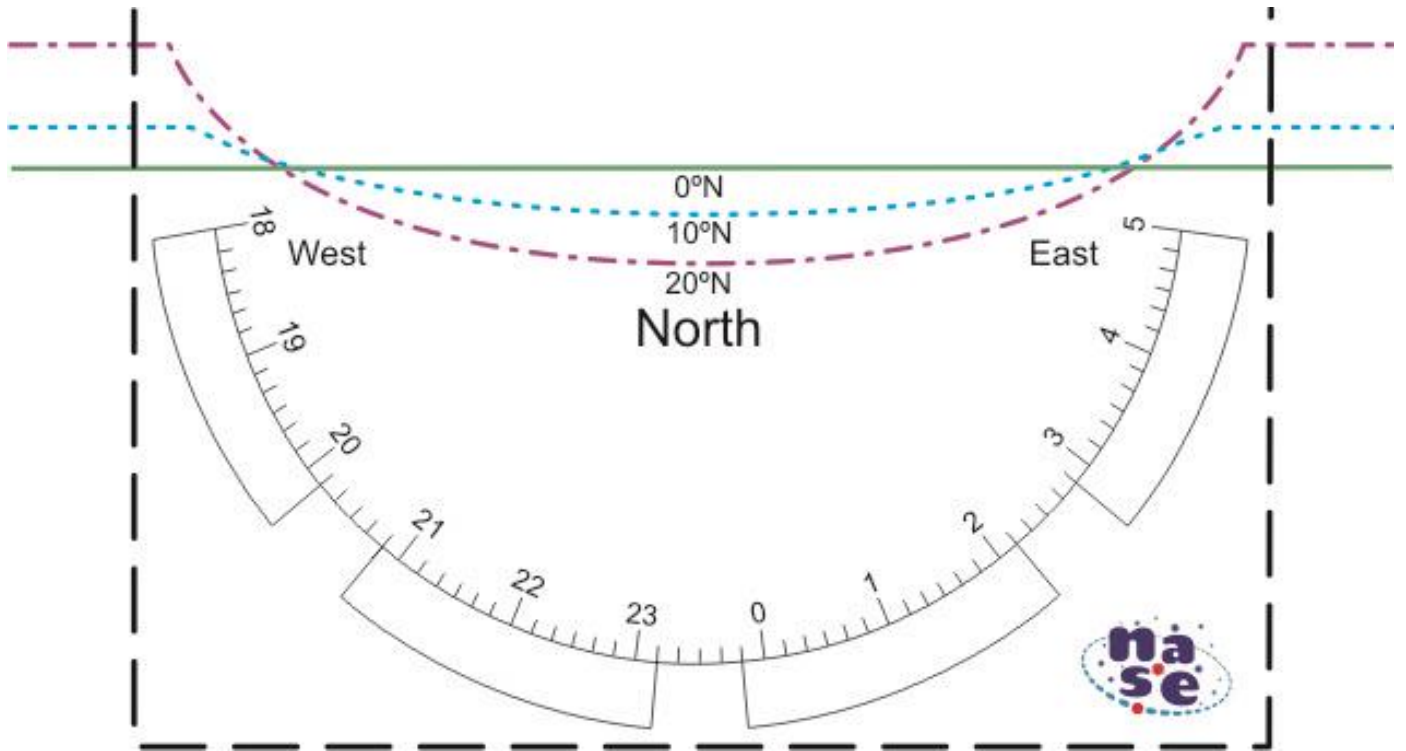

Fig. 9a: Pocket for the northern horizon in northern hemisphere (latitude 0, 10 and 20 North).

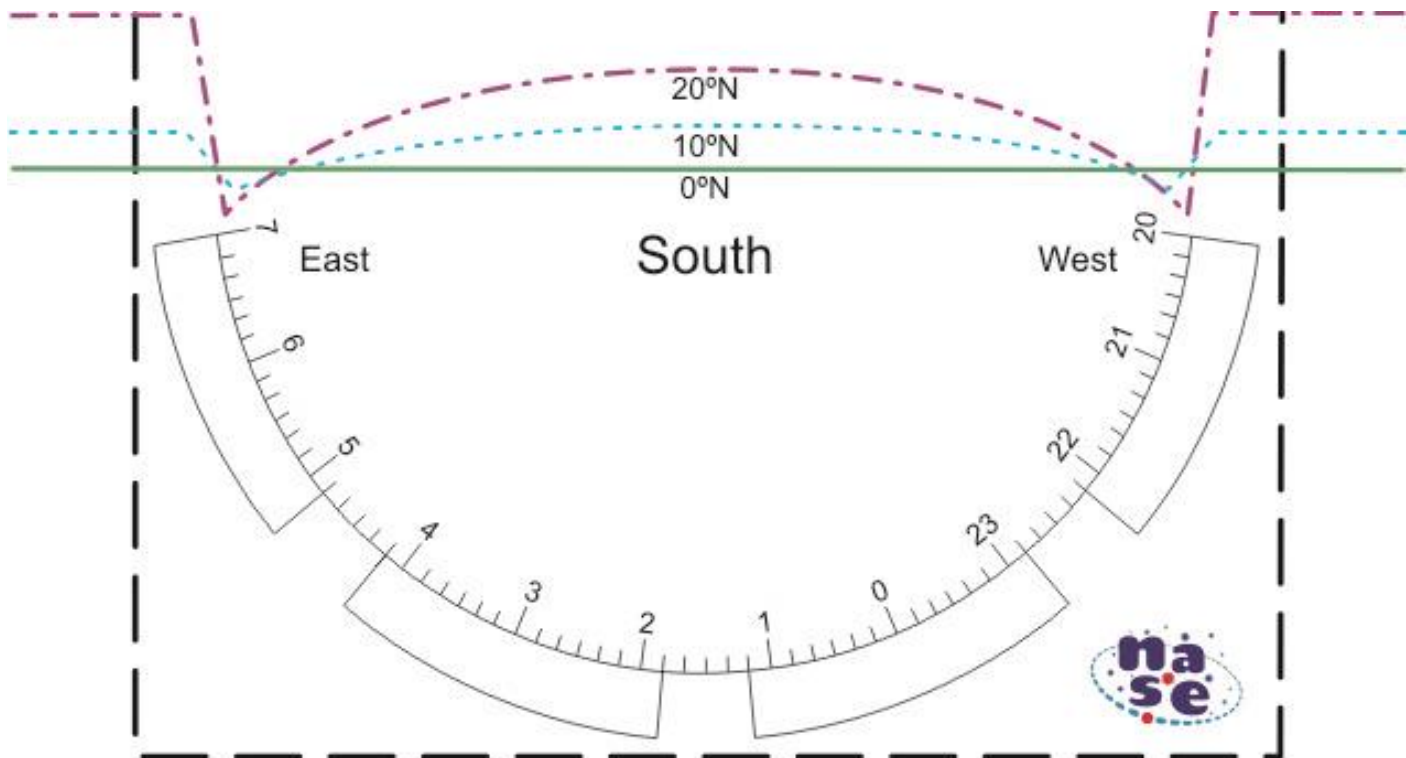

Fig. 9b: Pocket for the southern horizon in northern hemisphere (latitude 0, 10 and 20 North).



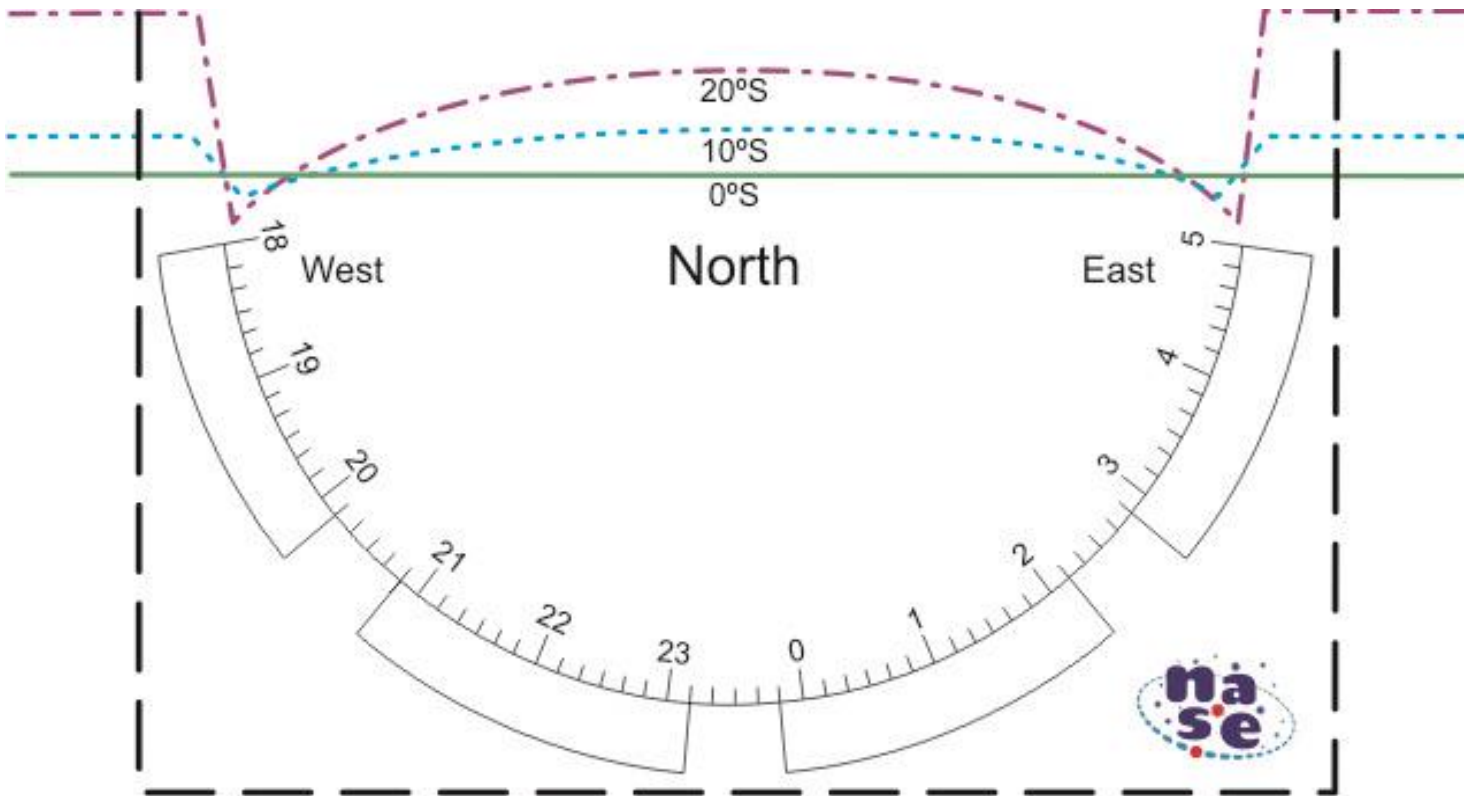

Fig. 9c: Pocket for the northern horizon in southern hemisphere (latitude 0, 10 and 20 South).

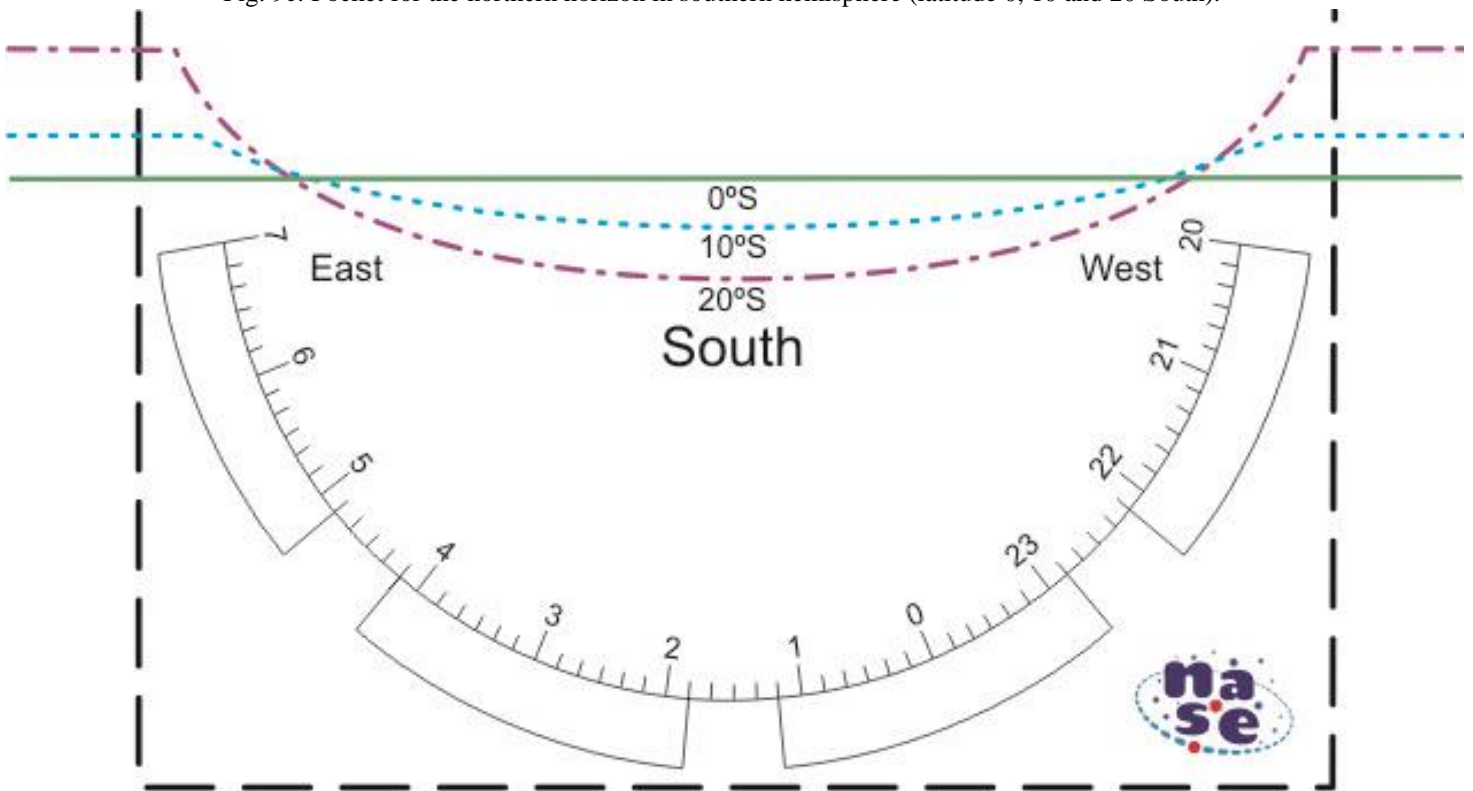

Fig. 9d: Pocket for the southern horizon in southern hemisphere (latitude 0, 10 and 20 South).

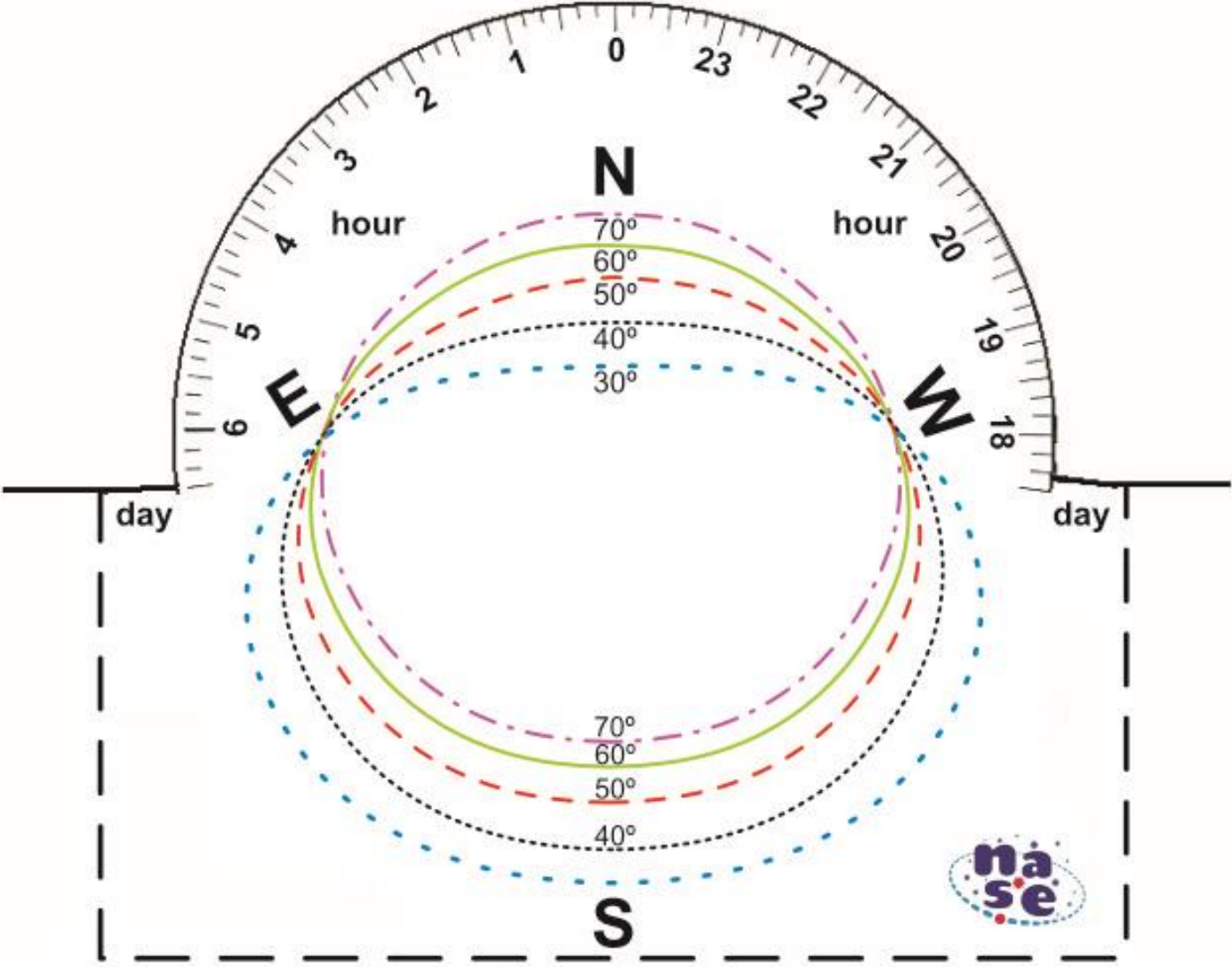

Fig. 9e: Pocket for both horizons in northern hemisphere. Latitudes 30, 40, 50, 60 and 70 North.

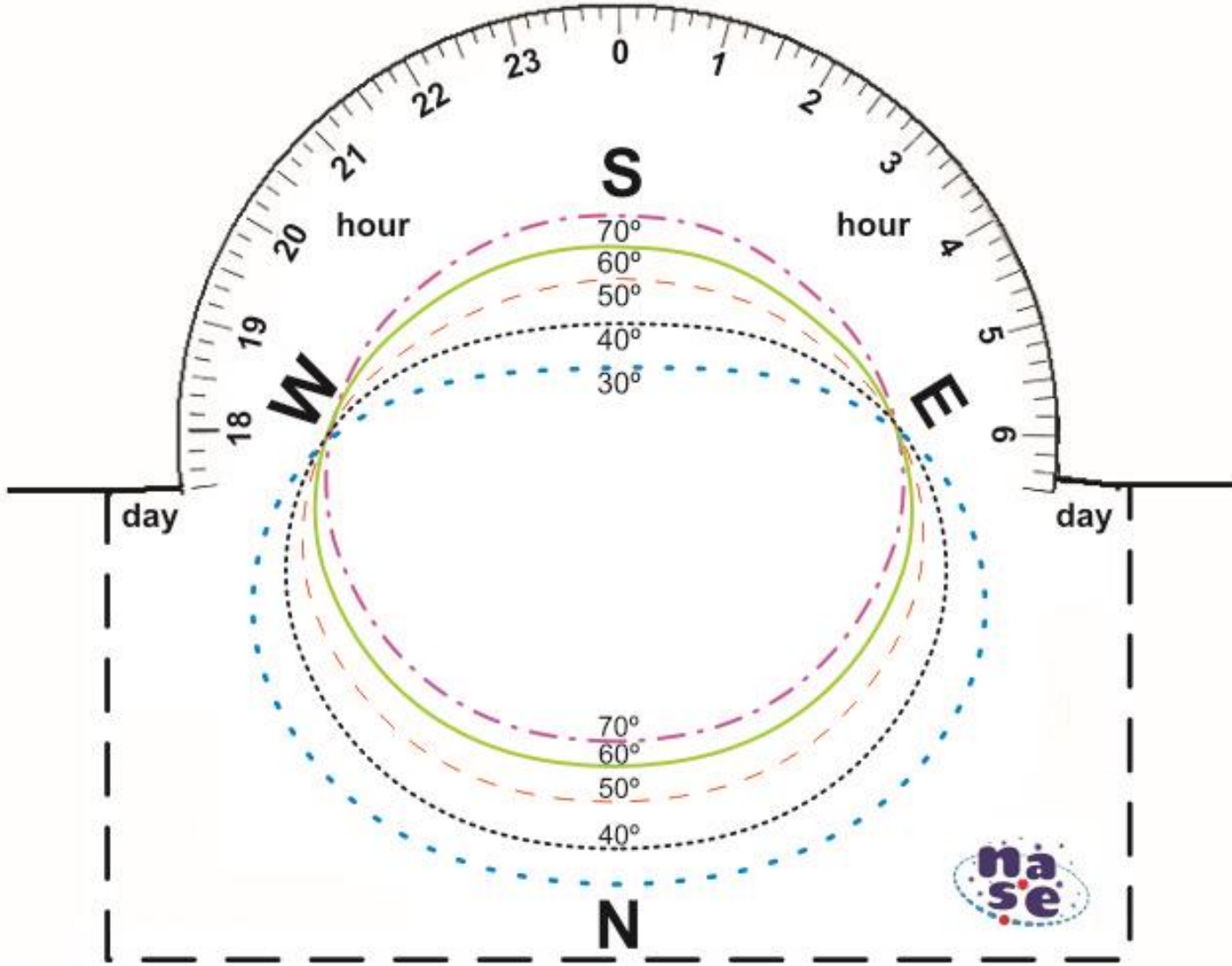

Fig. 9f: Pocket for both horizons in southern hemisphere. Latitudes 30, 40, 50, 60 and 70 South.

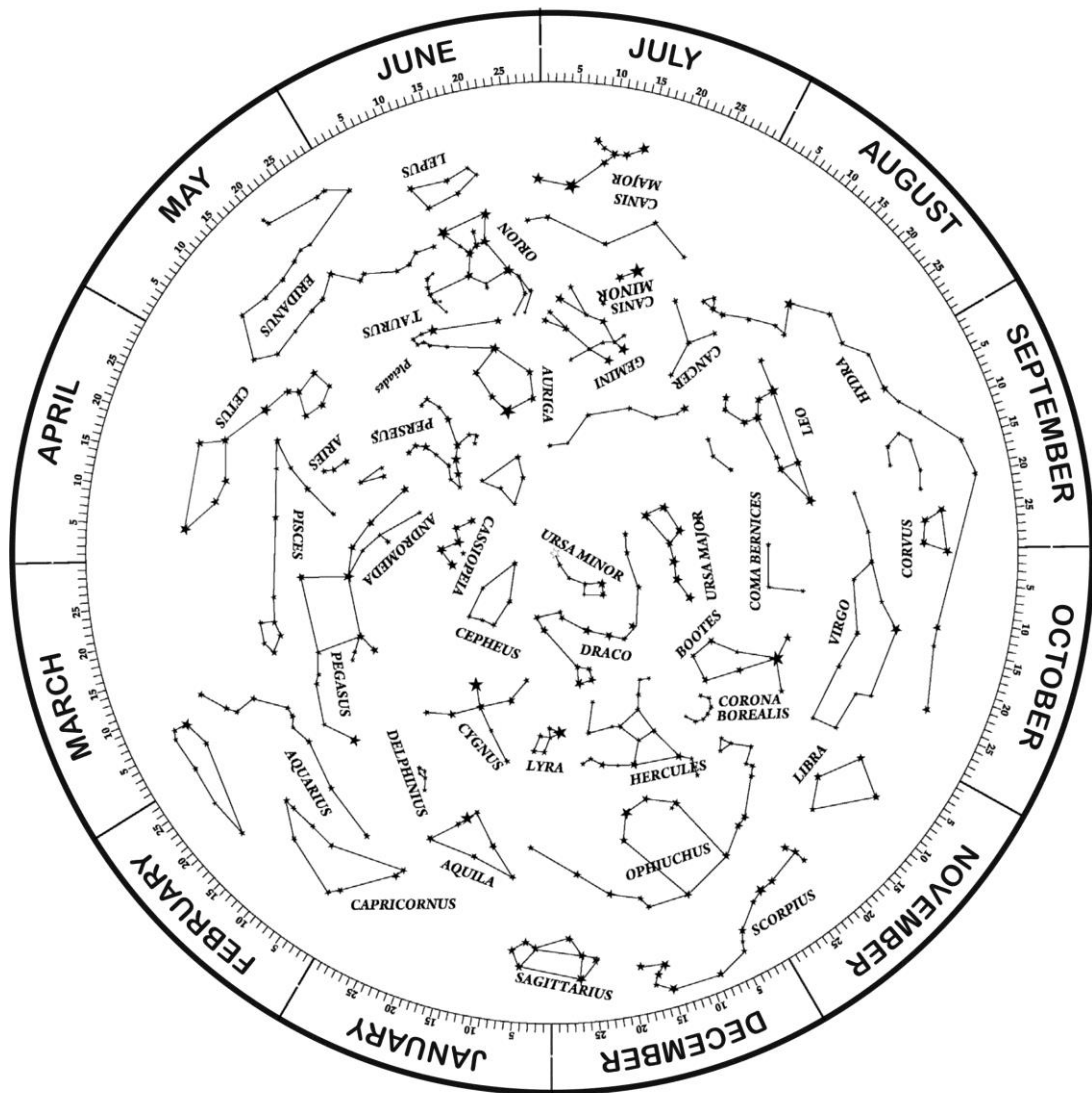

Fig. 10a: The disk or stellar map that is placed inside the pocket. Northern Hemisphere.

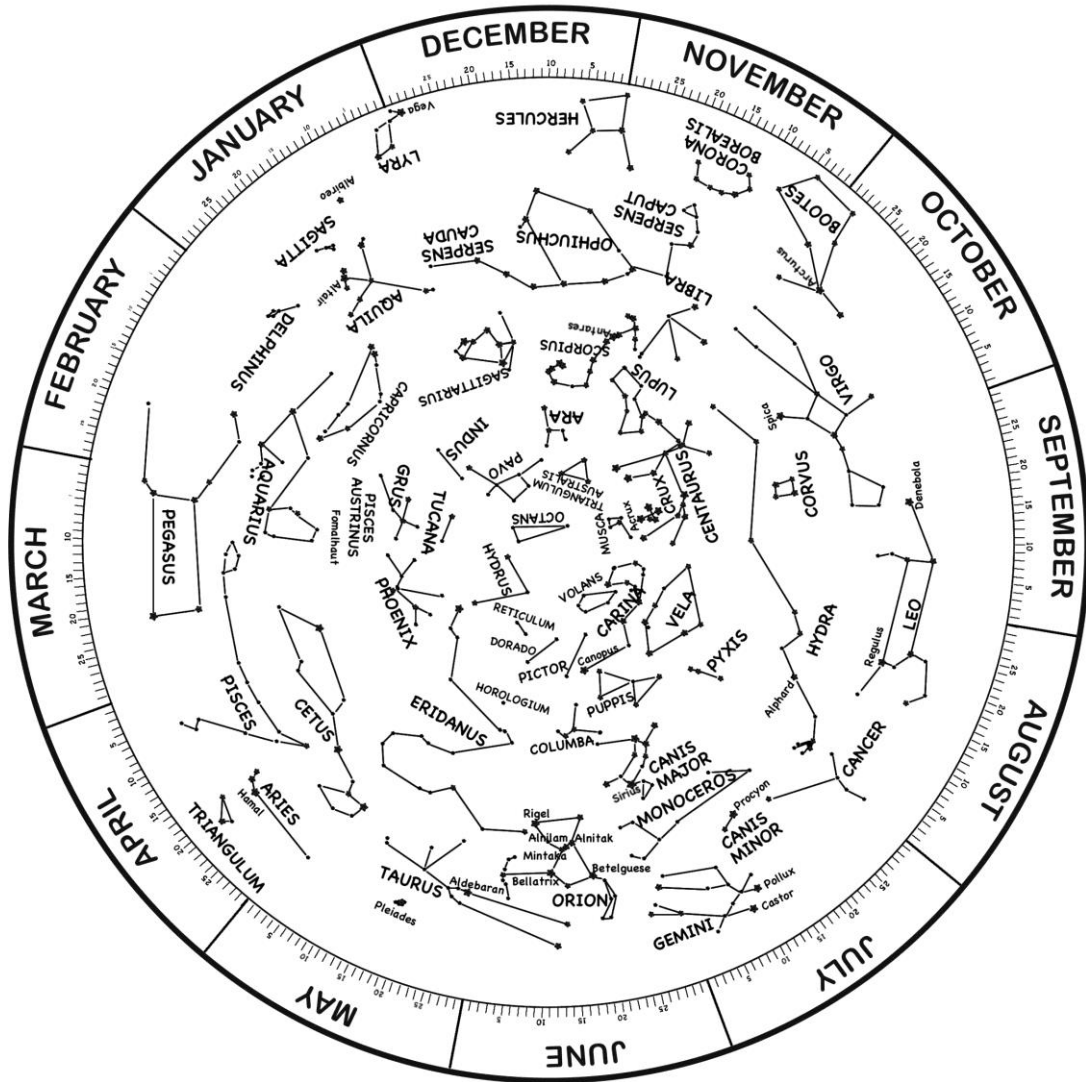

Fig. 10b: The disk or stellar map that is placed inside the pocket. Southern Hemisphere.

**Proposed exercises:****Which sky can we see tonight?**

Using the planisphere you've made for the latitude of your school, turn the stellar disc until today's date coincides with the time you plan to go out and observe.

Note that the planisphere is a "stellar map" and you have to lift it over your head "as an umbrella" (it is not a map of your city!).

**Spectroscopy**

By passing the light of the sun through this sensitive instrument, the student will be able to visualize the spectral decomposition of the light. This is a simple way for the students to observe the stellar spectrum with an instrument constructed with their own hands.

**How to make the spectroscope:** Paint the interior of a large matchbox (of the size typically used in a kitchen). Make a longitudinal cut (figure 11b) through which the observer can view the spectrum. Cut a damaged (or otherwise unusable) CD into 8 equal parts, and place one of the pieces inside the box, on the bottom, with the recordable surface facing up. Close the box, leaving only a small section open, opposite from where you constructed the viewing slit.

**How to use it:**

- Orient the matchbox so that the sunlight falls through the open section, and observe through the viewing slit (figure 11a)
- Inside the matchbox, you will see the sunlight split into the colors of its spectrum.

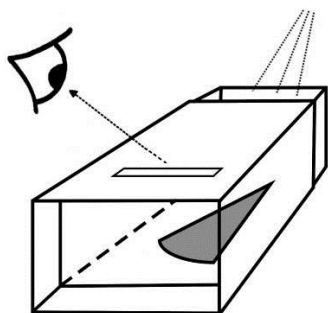

Fig. 11a and 11b: How to use the spectroscope.

**Proposed exercises:**

**Compare the solar spectrum with a fluorescent or other lamps that are in school.** You will be able to observe variations that appear in the spectrum depending on the type of lamp that you're viewing.

## Map of the Moon

It's good to include in your briefcase a simplified version of a lunar map that includes the name of the seas and some of the craters that can be seen with binoculars or with small telescopes.

**To build it:** You need a square piece of cardboard (about 20x20 cm) (figures 12 or 13).

### How to use it?:

- Be aware that the orientation will change depending on if you are using the naked eye, if you are using binoculars or a telescope (inverted image), and whether you are watching from the Northern or Southern Hemisphere. It is easiest to begin by identifying the seas, verify that the position is correct and then continue to identify other lunar features.

### Proposed exercise:

**Which is the Tycho crater?** Look at the moon when it is more than half illuminated and identify in the central zone a crater with a large system of rays (lines that leaves the crater and head in all directions across the surface of the satellite).

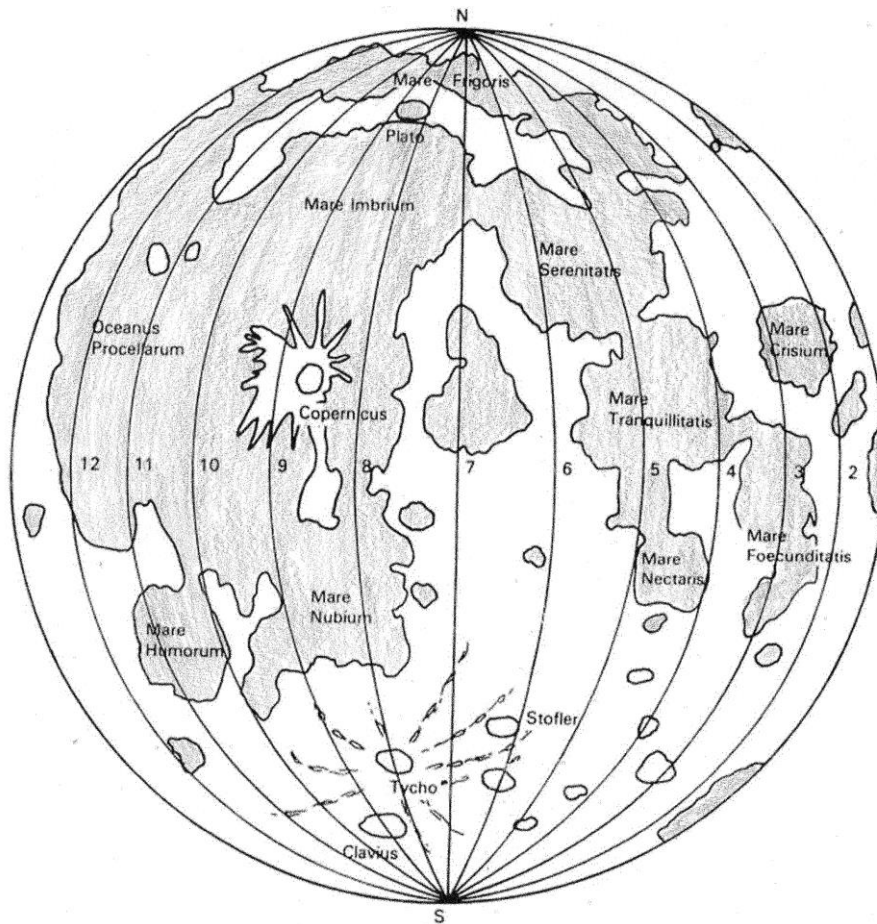

Fig. 12: Schematic map of the Moon.

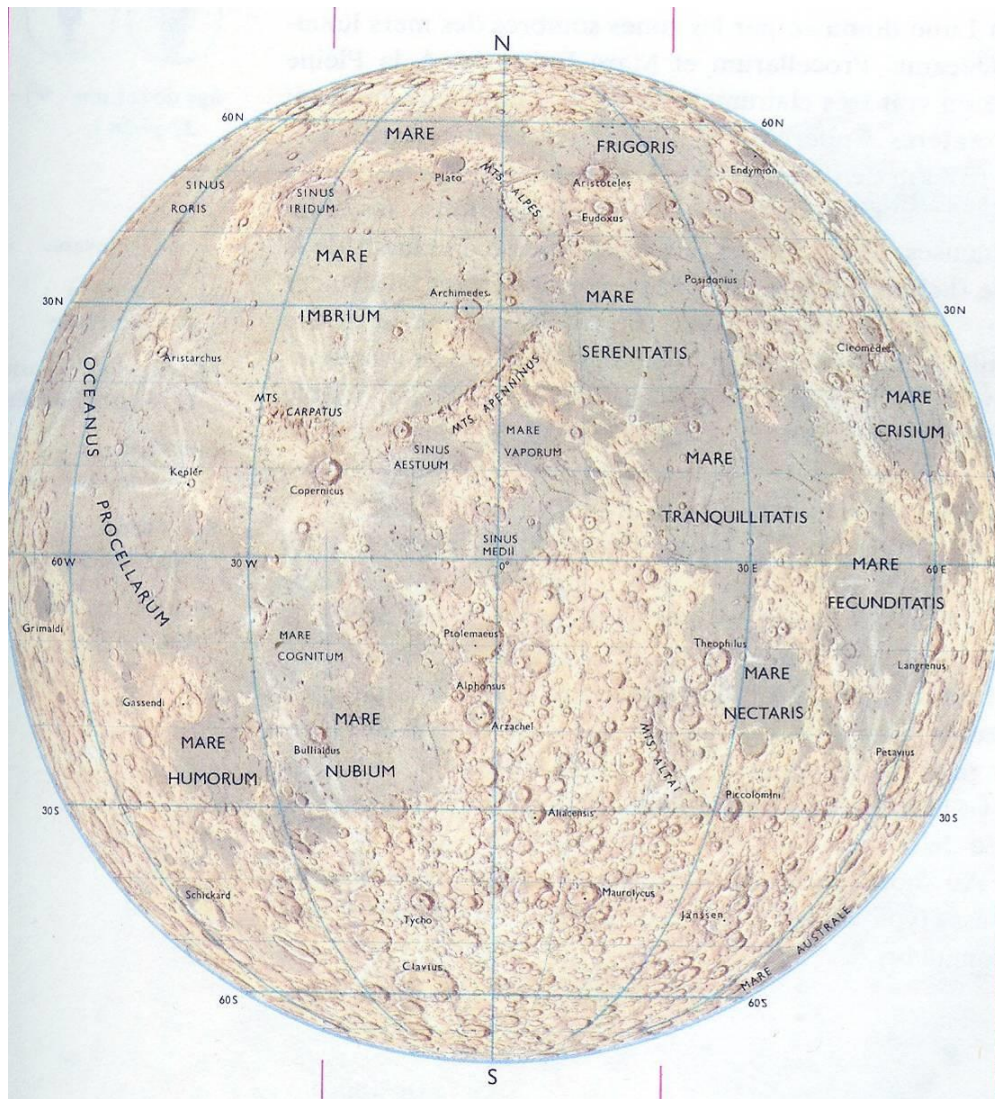

Fig. 13: Simplified map of the Moon.

### Organizing your Briefcase

Place a paper bag with a sheet on the upper side of the box open to store the planisphere, the map of the Moon, the sundial, etc.

In the deep part of the box place the instruments so that they can not move, using clips, pins, and small belts. The screw of the quadrant should be set around the center because the suitcase contains delicate instruments and can be balanced when handle it. A group of students proposed putting a list on the outside of the bag indicating its contents, so we would be sure to have gathered everything at the end of the activity. In addition, of course, labeled with your name and any decorations you can think of, in order to customize the suitcase.



## Conclusions

Observing how the sky moves during the night, the day and throughout the year is a must for young astronomers. With these kind of projects, students will be able:

- To gain confidence with the measures;
- To take responsibility for their own instruments;
- To develop their creativity and manual ability;
- To understand the importance of systematic collection of data;
- To facilitate the understanding of more sophisticated instruments;
- To recognize the importance of observation with the naked eye, then and now.

## Bibliography

- Palici di Suni, C., First Aid Kit. *What is necessary for a good astronomer to do an Observation in any moment?*, Proceedings of 9<sup>th</sup> EAAE International Summer School, 99, 116, Barcelona, 2005.
- Palici di Suni, C., Ros, R.M., Viñuales, E., Dahringer, F., *Equipo de Astronomía para jóvenes astrónomos*, Proceedings of 10<sup>th</sup> EAAE International Summer School, Vol. 2, 54, 68, Barcelona, 2006.
- Ros, R.M., Capell, A., Colom, J., *El planisferio y 40 actividades más*, Antares, Barcelona, 2005.

## Planets and exoplanets

**Rosa M. Ros**

International Astronomical Union, Technical University of Catalonia (Barcelona, Spain)

### Summary

This workshop provides a series of activities to compare the many observed properties (such as size, distances, orbital speeds and escape velocities) of the planets in our Solar System. Each section provides context to various planetary data tables by providing demonstrations or calculations to contrast the properties of the planets, giving the students a concrete sense for what the data mean. As a final activity, some properties of extrasolar planetary systems are explored and compared to the Solar System. At present, several methods are used to find exoplanets, more or less indirectly. It has been possible to detect almost 100 multiple planetary systems. A famous example is shown in figure 1.

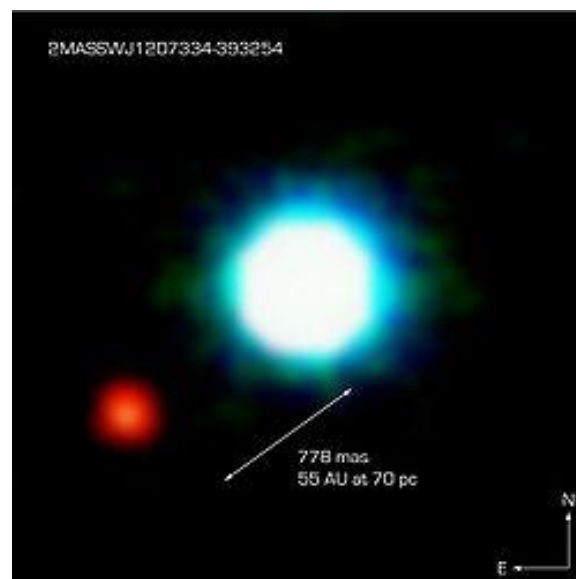

Fig. 1: The first planet directly observed 2M1207b in March 16th 2003. It has a mass 3.3 times the mass of Jupiter and orbits at 41 AU from the brown dwarf. In 2006, a disk of dust was found around the parent star, providing evidence that planet formation may proceed in a way similar to that observed around more massive solar-type stars. (Photo: ESO).

### Goals

- Understand what the numerical values in the Solar System summary data table mean.

- Deduce the orbital radii and orbital periods of the Galilean satellites of Jupiter using a set of photographic observations.
- Calculate Jupiter's mass using Kepler's third law.
- Understand the main characteristics of extrasolar planetary systems by comparing their properties to the orbital system of Jupiter and its Galilean satellites.

## Solar System and data tables

By creating scale models of the Solar System, the students will compare the different planetary parameters. To perform these activities, we will use the data in Table 1.

Planets	Diameter (km)	Distance to Sun (km)
Sun	1 392 000	
Mercury	4 878	$57.9 \cdot 10^6$
Venus	12 180	$108.3 \cdot 10^6$
Earth	12 756	$149.7 \cdot 10^6$
Mars	6 760	$228.1 \cdot 10^6$
Jupiter	142 800	$778.7 \cdot 10^6$
Saturn	120 000	$1 430.1 \cdot 10^6$
Uranus	50 000	$2 876.5 \cdot 10^6$
Neptune	49 000	$4 506.6 \cdot 10^6$

Table 1: Data of the Solar System bodies

In all cases, the main goal of the model is to make the data understandable. Millions of kilometers are not distances that are easily grasped. However, if translated to scaled distances and sizes, the students usually find them easier to comprehend.

## Model of the Solar System

### Models of diameters

Using a large piece (or multiple pieces if necessary) of yellow paper cut a circle representing the Sun. The Sun is scaled to be 139 cm in diameter such that 1 cm is 10 000 km. Cut the different planets out of plain cardboard or construction paper and draw their morphological characteristics. By placing the planets near the solar disk, students can grasp the different planetary scales.

With a scale of 1 cm per 10 000 km, use the following planetary diameters:

Sun 139 cm, Mercury 0.5 cm, Venus 1.2 cm, Earth 1.3 cm, Mars 0.7 cm, Jupiter 14.3 cm, Saturn 12.0 cm, Uranus 5.0 cm and Neptune 4.9 cm.

Suggestion: It is also possible to complete the previous model by painting the planets on a shirt, keeping the scale of the planets but only painting a fraction of the Sun.



Fig. 2a and 2b: Examples of shirts providing Solar and planetary diameter scale comparisons.

### Model of distances

By comparing the distances between the planets and the Sun we can produce another model that is easy to set up in any school hallway. First, simply cut strips of cardboard 10cm wide, linking them up to obtain a long strip of several meters (figure 3). Then, place the cutouts of the planets on it at their correct distances. Remind the students that the distance between the planets are not to scale with diameters. At the suggested scale, the planets would be one thousand times smaller as here we are using 1 cm per 10 000 000 km, while in the first activity above we used 1 cm per 10 000 km. If using a scale of 1cm per 10 million km the scaled distances are: Mercury 6cm, Venus 11cm, the Earth 15cm, Mars 23cm, Jupiter 78cm, Saturn 143cm, Uranus 288cm and Neptune 450cm.



Fig. 3: Model of distances.

Suggestion: A fun variation of this model is to use a toilet paper roll each sheet for scale. For example, you can take as scale a portion of paper for every 20 million km.

### Model of diameters and distances

The next challenge is to combine the two above activities and make a model representing the

bodies to scale, as well as the corresponding distances between them. It is not actually that easy to define a scale that allows us to represent the planets with objects that are not too small and still have distances that are not overly large, in which case the sizes and distances are not easily assimilated, and the model is not very useful for students. As a suggestion, it may be a good idea to use the schoolyard to make the model and use balls of varying diameters as appropriate.



Fig. 4: The Sun and the planets of the model of diameters and distances.

As an example, we provide a possible solution. At one end of the schoolyard we put a basketball about 25 cm in diameter that represents the Sun. Mercury will be the head of a needle (1 mm in diameter) located 10 m from the Sun. The head of a slightly larger needle (2 mm in diameter) will represent Venus at 19 m from the Sun, while Earth will be the head of another needle similar to the previous one (2 mm) at 27 m from the Sun. Mars is a slightly smaller needle head (1mm), located 41 m from the Sun. Usually, the schoolyard ends here, if not sooner. We will have to put the following planets in other places outside the schoolyard, but at landmarks near the school, so that the students are familiar with the distances. A ping-pong ball (2.5 cm diameter) corresponds to Jupiter at 140 m from the Sun. Another ping-pong ball (2 cm in diameter) will be Saturn at 250 m from the Sun, a glass marble (1 cm in diameter) will represent Uranus at 500 m from the Sun, and a final marble (1 cm), located at 800 m, will represent Neptune.

It should be emphasized that this planetary system does not fit into any school. However, if we had reduced the distances, the planets would be smaller than the head of a needle and would be almost impossible to visualize. As a final task, you can calculate what scale has been used to develop this model.

### Model on a city map

The idea is simple - using a map of the city to locate the positions of the different planets, assuming the Sun is located at the entrance to the school. As an example, we present the map of Barcelona with different objects (specifically fruits and vegetables) that would be located

on the different streets, so you can better imagine their size. As an exercise, we suggest that you do the same activity with your own city.

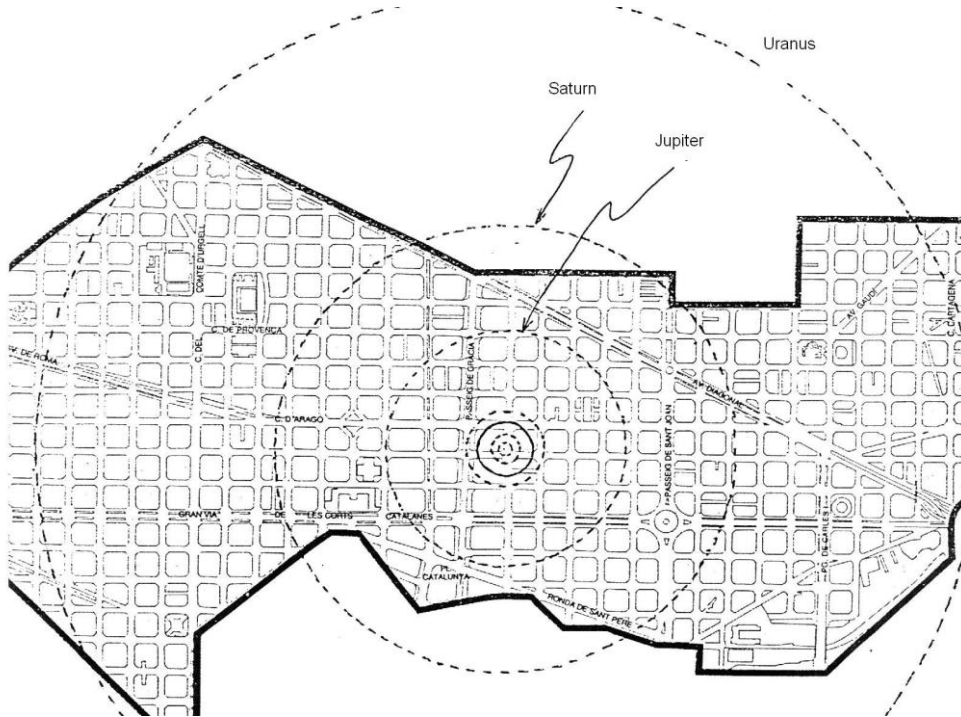

Fig. 5: Map of the “Ensanche de Barcelona” with some planets.

Using the map shown here, Mercury would be a grain of caviar, Venus and the Earth a couple of peas, Mars a peppercorn, Jupiter an orange, Saturn a tangerine and Uranus and Neptune a pair of walnuts. For the Sun, since there is no vegetable large enough, students should imagine a sphere roughly the size of a dishwasher. The instructor can do the same activity using their own city.



Fig. 6a and 6b: Snapshots of the city of Metz.

In the city of Metz (France) there is a solar system spread out on its streets and squares, with corresponding planets accompanied by information panels for those walking by.

### Models of light distances

In astronomy it is common to use the light year as a unit of measurement, which can often be confused as a measurement of time. This concept can be illustrated using a model of the Solar System. Since the speed of light is  $c = 300,000 \text{ km/s.}$ , the distance that corresponds to 1 second is 300,000 km. For example, to travel from the Moon to the Earth, which are separated by a distance of 384,000 km, it takes light  $384,000/300,000 = 1.3$  seconds.

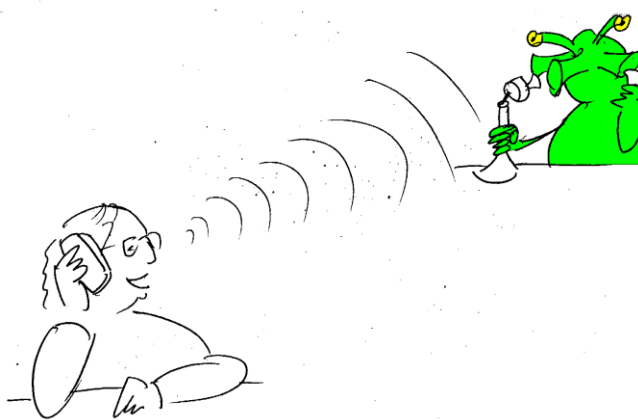

Fig. 7: Another example

Using these units, we will instruct the students to calculate the time required for sunlight to reach each of the planets of the Solar System. (For the instructor, here are the times required: the time it takes sunlight to reach Mercury is 3.3 minutes, to Venus it takes 6.0 minutes, to Earth 8.3 minutes, to Mars 12.7 minutes, to Jupiter 43.2 minutes, to Saturn 1.32 hours, to Uranus 2.66 hours and to Neptune, 4.16 hours.

You may want to ask the students to imagine what a video conference between the Sun and any of the planets would be like.

### Model of the apparent size of the solar disk from each planet

From a planet, for example the Earth, the Sun subtends an angle  $\alpha$  (figure 8). For very small values of  $\alpha$ , we take  $\tan \alpha \approx \alpha$  (in radians)

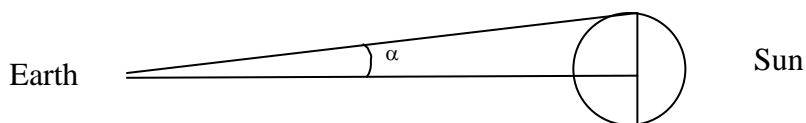

Fig. 8: From the Earth, the Sun subtends an angle  $\alpha$ .

Knowing that the solar diameter is  $1.4 \times 10^6 \text{ km}$ , ie a radius of  $0.7 \times 10^6 \text{ km}$ , and that the Earth-

Sun distance is  $150 \times 10^6$  km, we deduce:

$$\alpha \approx \text{tg} \alpha = \frac{0,7 \cdot 10^6}{150 \cdot 10^6} = 0,0045 \text{ radians}$$

And in degrees:

$$\frac{0,0045 \cdot 180}{\pi} = 0,255^\circ$$

That is, from the Earth, the Sun has a size of  $2 \times 0.255 \approx 0.51^\circ$ , i.e., about half a degree. Repeating the same process for each planet, we get the results in the following table 2 and we can represent their relative sizes (figure 9).

Planets	tan $\alpha$	$\alpha$ (°)	$\alpha$ (°) aprox.
Mercury	0.024	1.383	1.4
Venus	0.0129	0.743	0.7
Mars	0.006	0.352	0.4
Jupiter	0.0018	0.1031	0.1
Saturn	0.000979	0.057	0.06
Uranus	0.00048	0.02786	0.03
Neptune	0.0003	0.0178	0.02

Table 2: Results for the different planets.

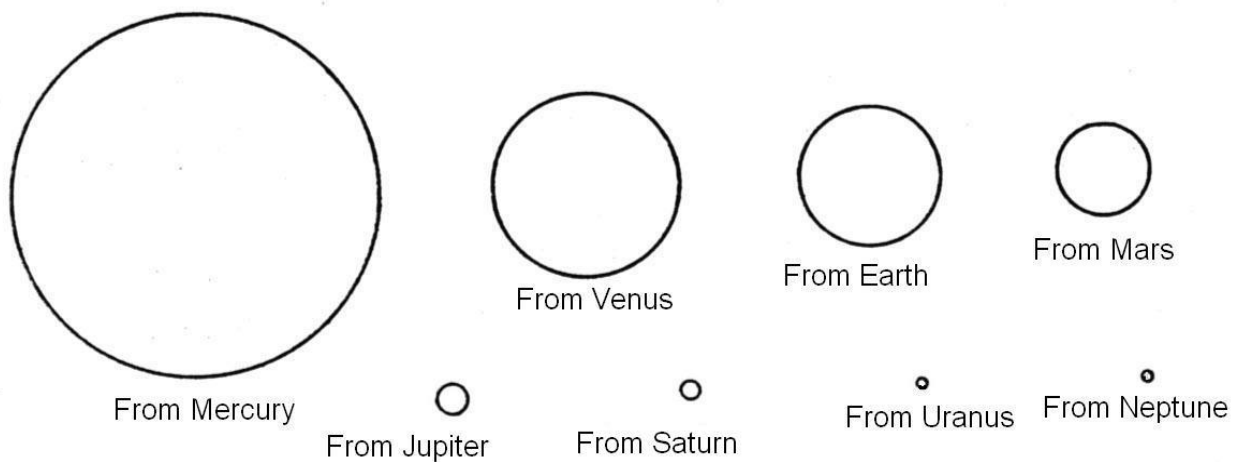

Fig. 9: The Sun seen from each planet: Mercury, Venus, The Earth, Mars, Jupiter, Saturn, Uranus and Neptune.

### Model of densities

The objective of this model is to look for samples of materials that are easily manipulated and have a density similar to each of the solar system bodies, in order to be able to "feel it in our hands."



	Density (g/cm <sup>3</sup> )
Sun	1.41
Mercury	5.41
Venus	5.25
Earth	5.52
Moon	3.33
Mars	3.9
Jupiter	1.33
Saturn	0.71
Uranus	1.3
Neptune	1.7

Table 3: Densities of the bodies in the Solar System



Fig. 10: Model of densities

From Table 3 of planetary densities, simply compare with the densities of various minerals (in every school there is usually a collection of materials) or with samples of other materials that are easy to find such as glass, ceramics, wood, plastics, etc.. The following Table 4 presents some examples of materials and their densities.

Minerals	Density	Other materials	Density
Plaster	2.3	Glycerin	1.3
Orthoclase	2.6	Cork	0.24
Sulfur	1.1-2.2	Aluminium	2.7
Alite	2	Iron	7.86
quartz	2.65	Cement	2.7 – 3.1
Borax	1.7	Glass	2.4 – 2.8
Blende	4	Tin	7.3
Pyrite	5.2	Clay	1.8 – 2.5
Erythrocytes	5.4	Bakelite	1.25
Calcite	2.7	Oak	0.90
Galena	7.5	Pinewood	0.55

Table 4: Examples of densities of some materials

When using materials not included in Table 4, it is very easy to calculate its density. Simply take a portion of this material, weigh it to find its mass,  $m$ , and put it in a container of water to measure its volume,  $V$ . The density  $d$  of the material will be,

$$d = \frac{m}{V}$$

Students should notice that Saturn would "float" in water, because its density is less than 1.

### Flattening model of planets

To visualize the deformation (flattening) of gas planets due to the centrifugal force generated by their rotation, we will build a simple model.

As we can see in figure 9, with a stick and some cardboard strips, we can build this simple model that reproduces the flattening of Solar System planets due to rotation.

1. Cut some cardboard strips 35 per 1 cm in size.
2. Attach both ends of the strips of cardboard to a 50 cm-long cylindrical stick. Attach the top ends to the stick so that they cannot move, but allow the bottom ends to move freely along the stick.

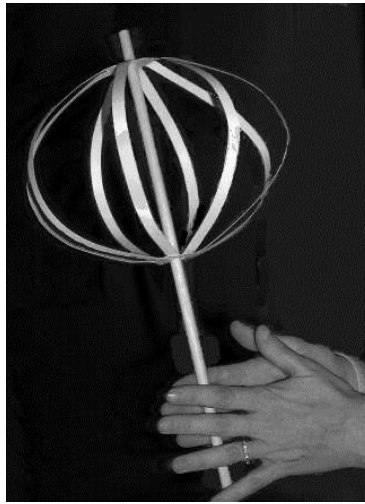

Fig. 11: Model to simulate flattening due to rotation

3. Make the stick turn by placing it between two hands, then rotating it quickly in one direction and then the other. You will see how the centrifugal force deforms the cardboard bands (figure 11) in the same way it acts on the planets.

### Model about planetary orbital speeds

It is well known that not all planets orbit the sun with the same speed (table 5).

Planet	Orbital average speed (km/s)	Distance from the Sun (km)
Mercury	47.87	57.9 10 <sup>6</sup>
Venus	35.02	108.3 10 <sup>6</sup>
Earth	29.50	149.7 10 <sup>6</sup>
Mars	24.13	228.1 10 <sup>6</sup>
Jupiter	13.07	778.7 10 <sup>6</sup>
Saturn	9.67	1 430.1 10 <sup>6</sup>
Uranus	6.84	2 876.5 10 <sup>6</sup>
Neptune	5.48	4 506.6 10 <sup>6</sup>

Table 5: Orbital data of the Solar System bodies

The fastest is Mercury, the closest, and the slowest is Neptune, the farthest. Romans had already noticed that Mercury was the fastest of all and so it was identified as the messenger of the gods and represented with winged feet. Even if observing with the naked eye, it is possible to tell that Jupiter and Saturn move much more slowly across the zodiacal constellations than do Venus and Mars, for example.

From Kepler's third law  $P^2/a^3 = K$ , it is deduced that the orbital speed decreases when the distance increases.

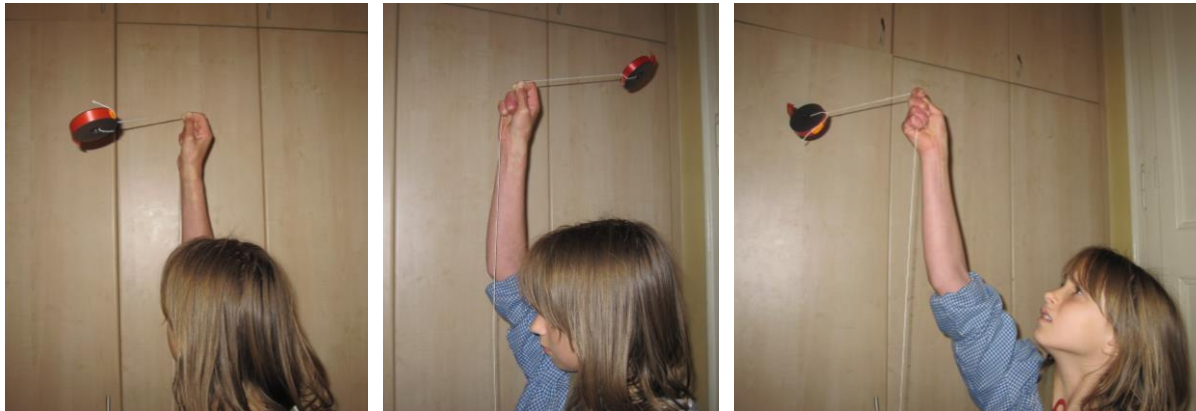

Fig. 12a, 12b and 12c: Simulating the circular movement of planets.

To view this relationship, there is also a simple way to experience this relationship. We begin by tying a heavy object, such as a nut, onto a piece of string. Holding the string from the end opposite the heavy object, we spin the object in a circular motion above our heads. We can then see that if we release string as we spin it (making the string longer), the object will lose speed. Conversely, if we take in string (making it shorter), it will gain speed. In fact, this (e.g. Kepler's third law) is a consequence of the conservation of angular momentum.

We can then develop a solar system model with nuts and bits of string proportional in length to the radii of the planetary orbits (assuming, again, that they all travel in circular orbits). However, instead of cutting a separate piece for each planet, cut all pieces to a length of about 20 cm. Then, using the appropriate scaling, measure the correct distance from the heavy

object and make a knot at this point. Then, the string can be held at the location of the knot while spinning the heavy object.

To use the model we must hold one of the strings at the location of the knot and turn it over our heads in a plane parallel to the ground with the minimum speed possible speed that will keep it in orbit. We will see that this velocity is greater in cases where the radius is smaller.

### Model of surface gravities

The formula for gravitational force,  $F = G \frac{Mm}{d^2}$ , allows us to calculate the surface gravity that acts on the surface of any planet. Considering a unit mass ( $m = 1$ ) on the planet’s surface ( $d = R$ ), we obtain  $g = \frac{GM}{R^2}$ . If we then substitute  $M = \frac{4}{3} \pi R^3 \rho$  for the planet mass, we find:

$$g = \frac{4}{3} \pi G \rho R$$

where  $G = 6.67 \times 10^{-11}$  is the universal gravitational constant,  $\rho$  is the density and  $R$  is the radius of the planet. Substituting these last two for the values listed in Table 1, we can calculate the value of the surface gravity,  $g$ , for all planets.

Planet	R ecuatorial Radius (km)	g surface gravity	$\rho$ Density
Mercury	2439	0.378	5.4
Venus	6052	0.894	5.3
Earth	6378	1.000	5.5
Mars	3397	0.379	3.9
Jupiter	71492	2.540	1.3
Saturn	60268	1.070	0.7
Uranus	25559	0.800	1.2
Neptune	25269	1.200	1.7

Table 6: Surface gravity and densities of the Solar System bodies

Let’s see a couple of examples:

$$g_{mercury} = \frac{4}{3} \pi G \ 5.4 \ 2439 = 3.7,$$

$$g_{venus} = \frac{4}{3} \pi G \ 5.3 \ 6052 = 8.9.$$

Similarly, we can calculate  $g$  for the rest of the planets. (Results are Mars: 3.7, Jupiter: 24.9, Saturn: 10.5, Uranus: 7.8 and Neptune: 11.8)

### Model of bathroom scales

In this case, the goal of the model is to develop a set of 9 bathroom scales (8 planets and the Moon) so that students can simulate weighing themselves on each of the planets and the moon.

Since the process is the same for each planet, we will only describe one of them. The idea, essentially, is to open up a bathroom scale and replace the disk labeled with weights with another with weights calibrated for a particular planet.

1. First, we open the scale. In most scales, there are two springs that secure the base. Remember that we have to put it back together again (figures 13a y 13b).
2. Once open, the weight disk should be removed, either to be replaced, or drawn over with the appropriate planetary weights.
3. In the following table we have surface gravities of the moon and various planets of the Solar System. In one column, they are listed in absolute values ( $m \cdot s^{-2}$ ), and in the other in relative values with respect to terrestrial gravity. These values are the ones we will use to convert units of “terrestrial” weight to proportional units of weight on other planets.
4. Finally, we close the scale again, and can now see what we would weigh on one of the planets

	Gravity ( $m \cdot s^{-2}$ )	Gravity (T=1)
Moon	1.62	0.16
Mercury	3.70	0.37
Venus	8.87	0.86
Earth	9.80	1.00
Mars	3.71	0.38
Jupiter	23.12	2.36
Saturn	8.96	0.91
Uranus	8.69	0.88
Neptune	11.00	1.12

Table 7: Surface gravities for each Solar System body.



Fig.13a and 13b: Bathroom scale with the replaced disk.



Fig. 14: Solar System model with bathroom scales.

### Models of craters

Most craters in the solar system are not volcanic but are the result falling meteoroids onto the surfaces of planets and satellites.

1. First, cover the floor with old newspapers, so that it doesn't get dirty.
2. Put a 2-3 cm layer of flour in a tray, distributing it with a strainer/sifter so that the surface is very smooth.
3. Put a layer of a few millimeters of cocoa powder above the flour with the help of a strainer/sifter (figure 15a).
4. From a height of about 2 meters, drop a projectile: a tablespoon of cocoa powder. The fall leaves marks similar to those of impact craters (figure 15b).
5. You may want to experiment with varying the height, type, shape, mass, etc. of the projectiles. In some cases, you can get even get a crater with a central peak.



Fig. 15a: Simulating craters.



Fig. 15b: Resulting craters.

### Model of escape velocities

If the launch speed of a rocket is not very large, the gravitational force of the planet itself makes the rocket fall back on its surface. If the launch speed is large enough, the rocket escapes from the planet's gravitational field. Let's calculate the speed above which a rocket can escape, i.e., the minimum launch speed or escape velocity.

Considering the formulas of uniformly accelerated motion,

$$e = \frac{1}{2} at^2 + v_0 t$$

$$v = at + v_0,$$

if we replace the acceleration by  $g$  and we consider the initial velocity  $v_0$  to be zero, we find that on the planet's surface,  $R = \frac{1}{2} gt^2$  and, moreover,  $v = gt$ . After removing the time variable, we find,

$$v = \sqrt{2gR},$$

where we can replace the values  $g$  and  $R$  by the values that are listed in the next table to calculate the escape velocity for each planet.

Planet	$R$ equatorial radius (km)	$g$ reduced surface gravity
Mercury	2439	0.378
Venus	6052	0.894
Earth	6378	1.000
Mars	3397	0.379
Jupiter	71492	2.540
Saturn	60268	1.070
Uranus	25559	0.800
Neptune	25269	1.200

Table 8: Radius and surface gravities of Solar System bodies.

As an example, we calculate the escape velocities of some planets. For example:

For the Earth,  $v_{earth} = \sqrt{2gR} = (2 \cdot 9.81 \cdot 6378)^{1/2} = 11.2$  km/s.

For the smallest planet, Mercury,  $v_{mercury} = (2 \cdot 9.81 \cdot 0.378 \cdot 2439)^{1/2} = 4.2$  km/s.

And for the greatest planet, Jupiter,  $v_{jupiter} = (2 \cdot 9.81 \cdot 2.540 \cdot 71492)^{1/2} = 60.9$  km/s.

It is clear that it is easier to launch a rocket from Mercury than from the Earth, but it is most difficult to launch a rocket on Jupiter, where the escape velocity is about 60 km / s.

(To be able to compare the results, the accepted escape velocity for each body in the Solar System are the following: Mercury 4.3 km/s, Venus 10.3 km/s, Earth 11.2 km/s, Mars 5.0

km/s, Jupiter 59.5 km/s, Saturn 35.6 km/s, Uranus 21.2 km/s, Neptune 23.6 km/s. As we can see, our simple calculations give us acceptable results.)

### Model of a rocket with an effervescent tablet

As an example of a rocket that can be launched safely in the classroom, we propose the following rocket, which uses an aspirin or effervescent tablet as a propellant. We begin by cutting out the rocket model on the solid lines, and pasting on the dotted lines like in the photo.

We will use a plastic capsule, such as a film canister, making sure that the capsule can fit inside the cylinder of the rocket. Then, we put the three triangles as supports on the body of the rocket and finally, add the cone on the top of the cylinder (figures 16a, 16b, 16c, 16d, 17, 18, 19a, 19b, 19c)

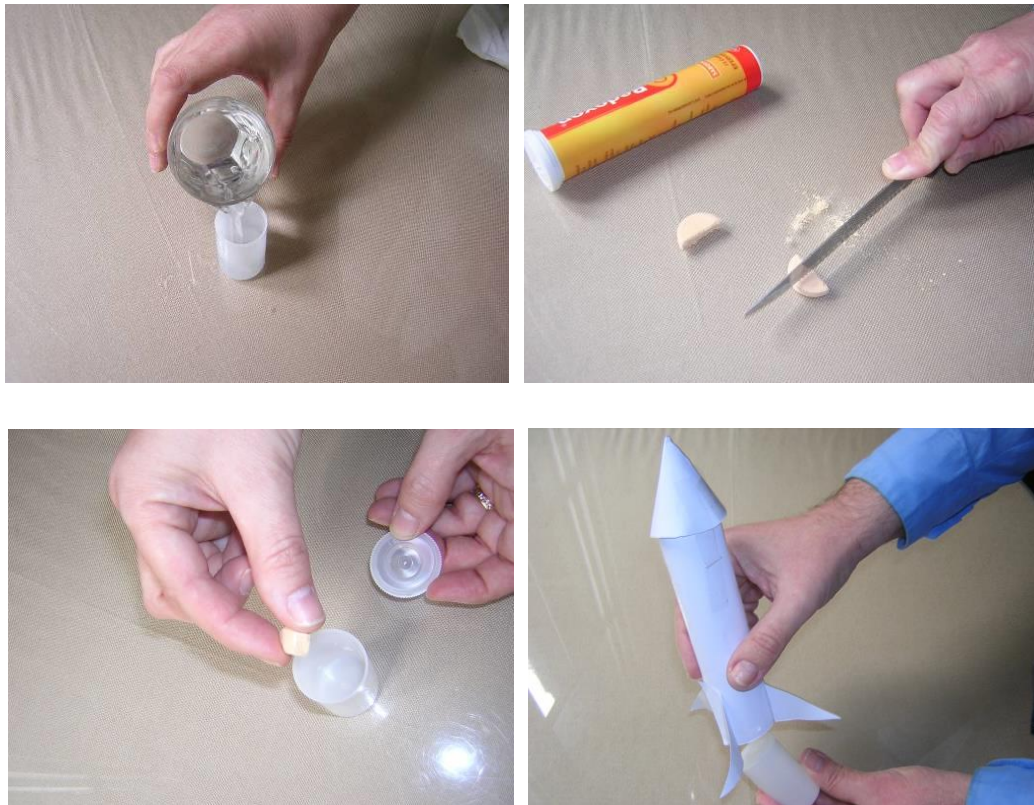

Fig. 16a, 16b, 16c and 16d: The process in four pictures.

After constructing the rocket, we have to carry out the launch. For this, we will put water into the plastic capsule, up to about  $\frac{1}{3}$  of its height (about 1 cm). Add  $\frac{1}{4}$  of an effervescent aspirin tablet (or other effervescent tablet). Put the tape and the rocket above the capsule. After about 1 minute, the rocket takes off. Obviously we can repeat as many times as we would like (at least  $\frac{3}{4}$  of the aspirin tablet remains, so enjoy launching rockets!).



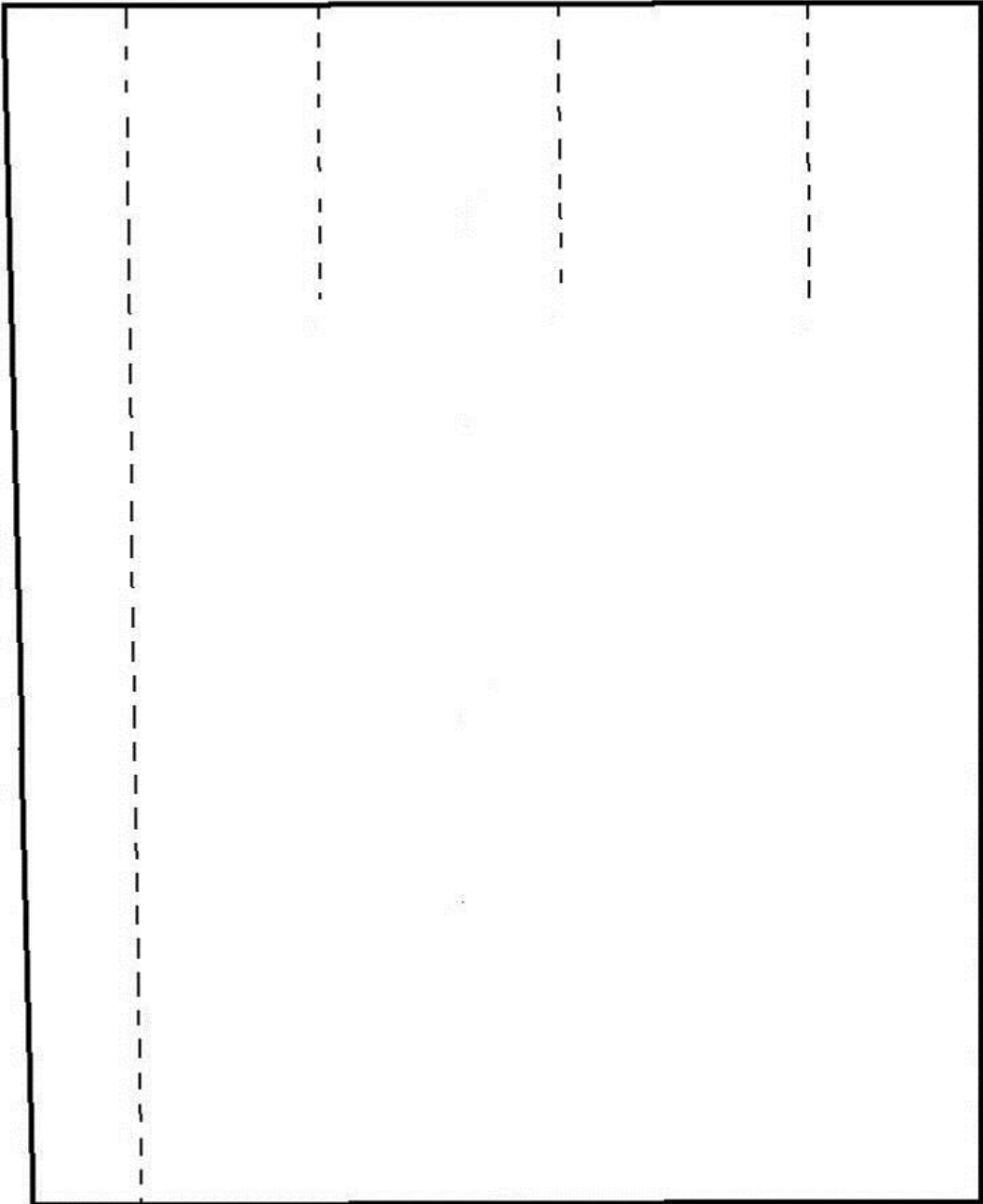

Fig. 19a: Body of the rocket. Paste the fins in the dotted zone.



Fig. 17: Some rockets.

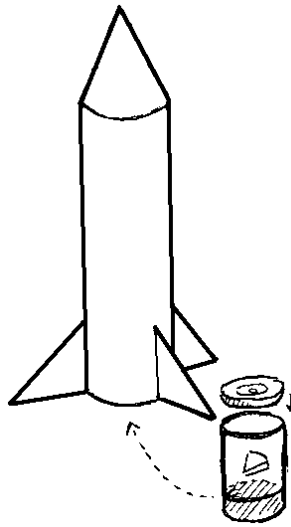

Fig. 18: Simplified scheme

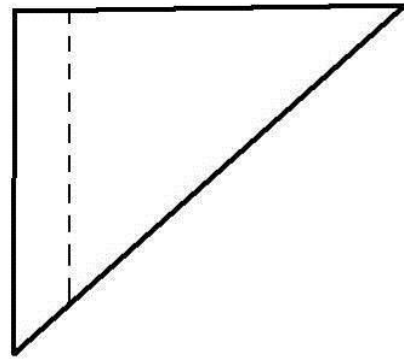

Fig. 19b: Model for the three fins.

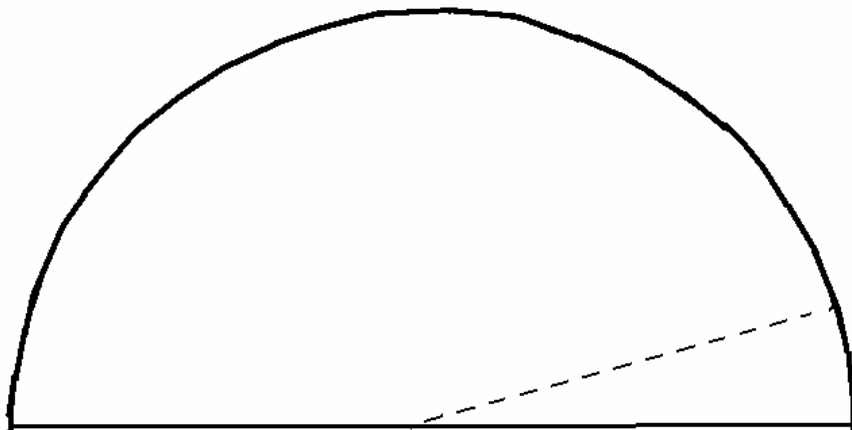

Fig. 19c: Top cone of the rocket.

## Models of exoplanetary systems

The Jet Propulsion Laboratory (NASA; <http://planetquest.jpl.nasa.gov/>) keeps a catalog of planetary objects discovered outside our own Solar System. There are more than 1800 confirmed planets. They are called exoplanets (short for extrasolar planets; most are similar in mass to or more massive than Jupiter, which is the largest planet in our Solar System. This is why we often compare the masses of extrasolar planets with the mass of Jupiter ( $1,9 \times 10^{27}$  kg). Only a few of the exoplanets are similar in mass to the Earth, but this is likely due to an observational bias since the latest detection techniques are better at detecting massive objects.

In this section, we consider some examples of extrasolar planetary systems that have more than three known planets.

The nomenclature of exoplanets is simple. A letter is placed after the name of the star,

beginning with "b" for the first planet found in the system (eg, 51 Pegasi b). The next planet detected in the system is labeled with the following letter of the alphabet such as, c, d, e, f, etc (51 Pegasi c, d 51 Pegasi 51 Pegasi 51 Pegasi e or f).

Planet name	Average Distane., Au	Orbital period, days	Minimum mass*, Jupiter masses	Discovery Date year	Diameter**, km
Ups And b	0,059	4,617	0,69	1996	~Jupiter 124 000
Ups And c	0,83	241,52	1,98	1999	~Jupiter 176 000
Ups And d	2,51	1274,6	3,95	1999	~Jupiter 221 000
<i>Gl 581 e</i>	<i>0,03</i>	<i>3,149</i>	<i>0,006</i>	<i>2009</i>	<i>Terrestrial 16000</i>
<i>Gl 581 b</i>	<i>0,04</i>	<i>5,368</i>	<i>0,049</i>	<i>2005</i>	<i>Terrestrial 32 000</i>
<i>Gl 581 c</i>	<i>0,07</i>	<i>12,929</i>	<i>0,016</i>	<i>2007</i>	<i>Terrestrial 22 000</i>
<i>Gl 581g(not confirmed)</i>	<i>0,14</i>	<i>36,562</i>	<i>0.009</i>	<i>2005</i>	<i>Terrestrial 18 000</i>
<i>Gl 581 d</i>	<i>0,22</i>	<i>68,8</i>	<i>0,024</i>	<i>2010</i>	<i>Terrestrial 25000</i>
<i>Gl 581 f(not confirmed)</i>	<i>0,76</i>	<i>433</i>	<i>0,021</i>	<i>2010</i>	<i>Terrestrial 24000</i>

Table 9:Extrasolar systems with multiple planets (three or more). Data from the *Extrasolar Planets Catalog*<sup>2</sup> (except the last column). \* The radial velocity method only gives the minimum mass of the planet. \*\* The diameter shown in the last column of Table 1 has been calculated assuming that the density of the planet is equal to the density of Jupiter (1330 kg / m<sup>3</sup>) for gaseous planets. For planets considered to be terrestrial, the diameter was calculated using the density of the Earth (5520 kg / m<sup>3</sup>).

Some exoplanets are very close to the central star, for example Gliese 876 with closer orbits that Mercury is from the sun. Others have more distant planets (HD 8799 has a planetary system with three planets about as far as Neptune is from the sun.) One possible way to display these data is to build scale models of the chosen planetary system. This allows us to easily compare them with each other and with our Solar System.

Planet name	Average Distance, AU	Orbital Period, years	Mass, Jupiter masses	Diameter, km
Mercury	0.3871	0.2409	0.0002	4879
Venus	0.7233	0.6152	0.0026	12,104
Earth	1.0000	1.0000	0.0032	12,756
Mars	1.5237	1.8809	0.0003	6,794
Jupiter	5.2026	11.8631	1	142,984
Saturn	9.5549	29.4714	0.2994	120,536
Uranus	19.2185	84.04	0.0456	51,118
Neptune	30.1104	164.80	0.0541	49,528

Table 10: Solar System planets.

Today we know that there are exoplanets around different types of stars. In 1992, radio astronomers announced the discovery of planets around the pulsar PSR 1257 +12. In 1995, the first detection of an exoplanet around a G-type star, 51 Pegasi, was announced, and since then exoplanets have been detected in orbit around: a red dwarf star (Gliese 876 in 1998), a

giant star (Iota Draconis in 2001) , a brown dwarf star (2M1207 in 2004), a K-type star (HD40307 in 2008) and an A–type star (Fomalhaut in 2008), among others.

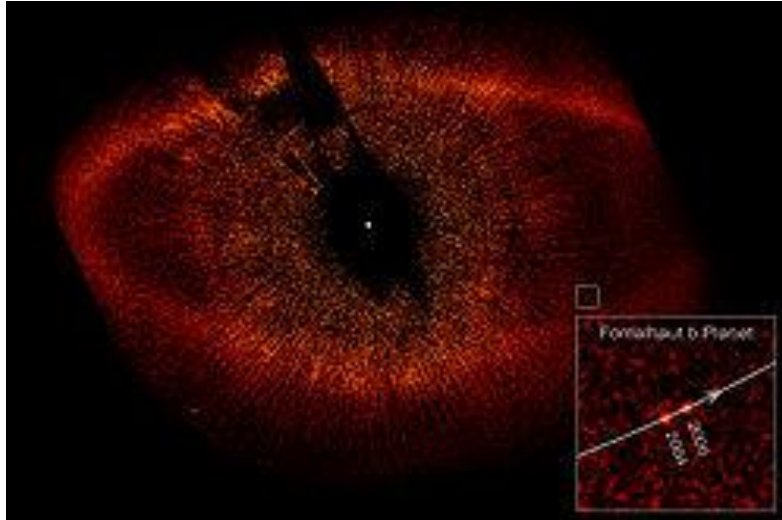

Fig. 20: Planet Fomalhaut b located in a debris disk, in an image of Fomalhaut taken by the Hubble Space Telescope (Photo:NASA).

### Determination of the diameter of exoplanets

First, we will calculate the diameter of a couple of exoplanets included in Table 9.

We can achieve this goal by assuming that we know the density of the exoplanet. For our study, we consider that gaseous planets have the density of Jupiter and that terrestrial exoplanets have the same density as the planet Earth. By definition, the density of a body of mass  $m$  is given by :  $\rho = m/ V$

The mass,  $m$ , of the exoplanet appears in table 8, and the volume  $V$  can be obtained considering the planet to be a sphere:  $V = 4 \pi R^3/3$

If we substitute this formula in the previous one, we can obtain the radius of the exoplanet:

$$R = \sqrt[3]{\frac{3m}{4\pi\rho}}$$

We suggest that the reader calculate the diameter of Gliese 581d (terrestrial exoplanet) assuming its density is  $\rho = 5520 \text{ kg/m}^3$  (the density of the Earth). Then repeat the calculation for a non-terrestrial exoplanet such as the the first multiple planetary system that was discovered around a main sequence star, Upsilon Andromedae. This system consists of three planets, all of them similar to Jupiter: Ups planets b, c and d. Calculate their diameters assuming  $\rho = 1330 \text{ kg/m}^3$  (the density of Jupiter) and compare the results with those in Table 9.

Using these results and the average distance taken from Table 9, we can produce a model in the next section.

### Determination of the central star mass

Using the values of table 9 and Kepler's third law, we can determine the mass of the central star  $M$ . Kepler's third law states that for a planet with period  $P$  and an orbit of radius  $a$ ,  $a^3/P^2$  is a constant. We can show that this constant is the mass of the central star, expressed in solar masses. If we consider the motion of exoplanets around the star in a circular orbit of radius  $a$ , we can write

$$m v^2/a = G M m / a^2$$

For circular motion, the speed  $v$  is  $v^2 = G M / a$ . The period,  $P$ , for circular motion, is  $P = 2 \pi a/v$ . Then, when we introduce the value of  $v$ , we deduce:

$$P^2 = 4 \pi^2 a^3 / (G M)$$

And, for each exoplanet, using Kepler's third law,

$$a^3 / P^2 = (G M) / (4 \pi^2)$$

Writing the previous relation for the Earth's motion around the Sun, using  $P=1$  year and  $a=1$  AU, we deduce the following equation:

$$1 = (G M_S) / (4 \pi^2)$$

Dividing the last two equalities, and taking the sun's mass as unity, we obtain:

$$a^3 / P^2 = M$$

where  $a$  is the radius of the orbit (in AU),  $P$  is the period of revolution (in years). This relation allows us to determine the mass of the central star in units of solar masses.

Expressing the same relationship in different units, we can write:

$$M = 0,0395 \cdot 10^{-18} a^3 / P^2$$

where  $a$  is the radius of the orbit of the exoplanet (in km),  $P$  is the period of revolution of the exoplanet  $a$  (in days) and  $M$  is the mass of the central star (in solar masses). For example, calculate the mass of the stars Upsilon And and Gl 581 in solar masses (the result should be equal to 1.03 and 0.03 solar masses, respectively).

### Scale model of an exoplanetary system

First we choose the model scale. For distances, the appropriate scale is: 1 AU = 1 m. In this case all exoplanets can fit inside a typical classroom, as well as the first five planets in our Solar System. If the activity is carried out outside (e.g. in the school yard), we can build a complete model. A different scale needs to be used for the size of the planet, for example:

10,000 km = 0.5 cm. In this case, the largest planet, Jupiter, is 7 cm in diameter and the smallest (Mercury) will be 0.2 cm in size. Now we can build the Solar System, the Upsilon Andromedae and Gliese 581 systems using the average distance values included in Tables 9 and 10, and the previously-calculated diameters.

In the past few years we have learned that the planetary systems configurations are diverse. Some of the exoplanets orbit around their stars much closer than any planet in our own Solar System orbits around the sun. Other exoplanets are closer to their parent star than Mercury is from the Sun. This means they are very hot. Another difference is that many large planets are close to their stars.

The inner part of the Solar System is populated by the small, rocky planets and the first of the gas giant planets, Jupiter, is at 5.2 AU from the Sun. These differences are believed to be mainly due to an observational bias. The radial velocity method for example is more sensitive when the planets are in smaller orbits and are more massive. But we may assume that most exoplanets have much larger orbits. It seems plausible that in most exoplanetary systems, there are one or two giant planets with orbits similar in size to those of Jupiter and Saturn.

We now consider the habitability of exoplanets. The habitable zone is the region around a star where a planet with sufficient atmospheric pressure can maintain liquid water on its surface. This is a conservative definition and it is restricted to life as we know it on Earth. Some planetary scientists have suggested to include equivalent zones around stars where other solvent compounds such as ammonia and methane could exist in stable liquid forms.

Rough calculations indicate that the solar system's habitable zone, where liquid water can exist (i.e. where the temperature ranges from 0° to 100° C), ranges from 0.56 to 1.04 AU. The inner edge of this zone lies between the orbits of Mercury and Venus and the outer edge is just outside the orbit of Earth. Only two planets in the Solar System (Venus and Earth) are inside the habitable zone (the blue area in figure 21). As we know, only the Earth is inhabited, since Venus is too hot (but only because of a strong greenhouse effect on the planet).

It appears that Gliese 581d is an example of a terrestrial exoplanet within the habitable zone of its parent star, and it may be a potential candidate for extraterrestrial life. Gliese 581 c, on the other hand, might be within the habitable zone of its host star. Its orbit lasts 13 days and it is situated 14 times closer to its star than the Earth lies from the Sun. Nevertheless, the smaller size of the star makes this distance favorable for the planet to harbor liquid water and to offer the possibility of life. Its radius is 1.5 times that of the Earth and this indicates that it is a rocky body. Its temperature ranges from 0° C to 40° C, which makes possible the existence of abundant liquid water. The problem is that it always presents the same face to the star. This evidence could suggest that the planet could be rocky like Earth or that it could be covered with oceans. Although, in contrast, some studies indicate that this planet is suffering from a significant greenhouse effect, like Venus. Gliese 581 e is one of the smallest exoplanets ever discovered to date. Its mass is 1.7 the mass of the Earth, which makes it the smallest planet discovered and the closest in size to the planet Earth, although it has an orbit very close to its parent star at 0.03 AU. This fact makes it difficult to hold an atmosphere and puts it out of the habitable zone as the proximity of its parent star means that the temperatures

are above  $100^{\circ}\text{C}$ . At these temperatures, water is not in the liquid phase and life as we know it is not possible.

Gliese 581 g is the first exoplanet to be found within the habitable zone, with enough gravity to hold an atmosphere (3 to 4 times the mass of Earth) and the right temperature to shelter liquid water ( $-31^{\circ}\text{C}$  to  $-12^{\circ}\text{C}$ ).

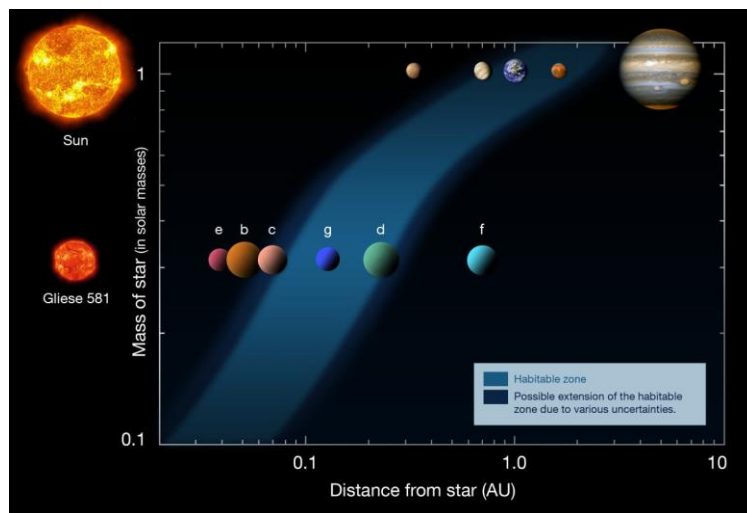

Fig. 21: The habitable zone. Comparison between the Solar System and the system of exoplanets in Gliese 581. The blue region indicates the zone where life as we know it could exist.

There are still many unanswered questions about the properties of exoplanets and there is much more to learn about their properties and characteristics.

## Bibliography

- Berthomieu, F., Ros, R.M., Viñuales, E., *Satellites of Jupiter observed by Galileo and Roemer in the 17<sup>th</sup> century*, Proceedings of 10<sup>th</sup> EAAE International Summer School, Barcelona, 2006.
- Gaitsch, R., *Searching for Extrasolar Planets*, Proceedings of 10<sup>th</sup> EAAE International Summer School, Barcelona 2006.
- Ros, R.M., *A simple rocket model*, Proceedings of 8<sup>th</sup> EAAE International Summer School, 249, 250, Barcelona, 2004.
- Ros, R.M., *Measuring the Moon's Mountains*, Proceedings of 7<sup>th</sup> EAAE International Summer School, 137, 156, Barcelona, 2003.
- Ros, R.M., Capell, A., Colom, J., *Sistema Solar Actividades para el Aula*, Antares, Barcelona, 2005.
- Ros, R.M., Viñuales, E., *Determination of Jupiter's Mass*, Proceedings of 1<sup>st</sup> EAAE International Summer School, 223, 233, Barcelona, 1997.
- Ros, R.M., Viñuales, E., Saurina, C., *Astronomía: Fotografía y Telescopio*, Mira Editores, Zaragoza, 1993.
- Vilks I., *Models of extra-solar planetary systems*, Proceedings of 10<sup>th</sup> EAAE International Summer School, Barcelona 2006.

## Preparing for Observing

**Francis Berthomieu, Ricardo Moreno, Beatriz García, Rosa M. Ros**

International Astronomical Union, CLEA (Niza, France), Retamar School (Madrid, Spain), National Technological University (Mendoza, Argentina), Technical University of Catalonia (Barcelona, Spain)

### Summary

A star party can be a way to learn and have fun, especially if you do it with a friend or with a group of friends. You have to prepare for it, especially if you plan to use some instruments. But don't neglect the simple joy of watching the sky with the unaided eye or binoculars.

### Goals

- Explain how to choose the correct place, time, and date, what equipment you will take and how to plan the event.
- Learn to use the program Stellarium.
- Recognize the Light Pollution problem.

### Choosing the place and date

Atmospheric light greatly affects our perception of the sky. In cities you can only see the sun, the moon, a few planets, and a few bright stars and satellites. It is far better to observe from a dark location, although you might have to give up the advantage of being able to do it at school or from home.

If you want to see more stars and nebulae, you must go to a site away from roads and towns, because cities send up a halo of light that prevents proper vision. This phenomenon is known as "light pollution". Also avoid the vicinity of isolated lamps or lights. Stay away from roads where cars can dazzle us with their headlights; look for a clear area where large trees don't interfere with your view of the sky.

In choosing a date, of course, you want clear weather without clouds. It's even better when the temperatures are comfortable (we recommend checking the weather by Internet). The phase of the Moon is very important. The worst days are when the moon is full, since it will produce a lot of ambient light and we will see only the brightest stars. When is waning, the moon will rise later, we will not see it unless we stay watching until dawn, but dark skies are assured in the early evening. Perhaps the most interesting are the days when the moon is just under first quarter, since the early hours of the night we can see the craters of the moon, and as the moon sets under the horizon, a few hours later, dark sky for our observing session.

If we have a telescope we should go to chosen location before sunset while we have enough natural light to set up the equipment before darkness.



## Equipment needed

**Planning the observations.** We need to remember that the sky changes as the observer's latitude. You can get the program Stellarium ([www.stellarium.org](http://www.stellarium.org), See the Annex to this unit for a quick guide), look in astronomy magazines, or examine books. On the web there are many places to obtain sky charts, for example [www.heavens-above.com/skychart](http://www.heavens-above.com/skychart) or in [www.skyandtelescope.com](http://www.skyandtelescope.com). To obtain any of these sky maps you must indicate the location, (usually latitude and longitude), date, and time of day.

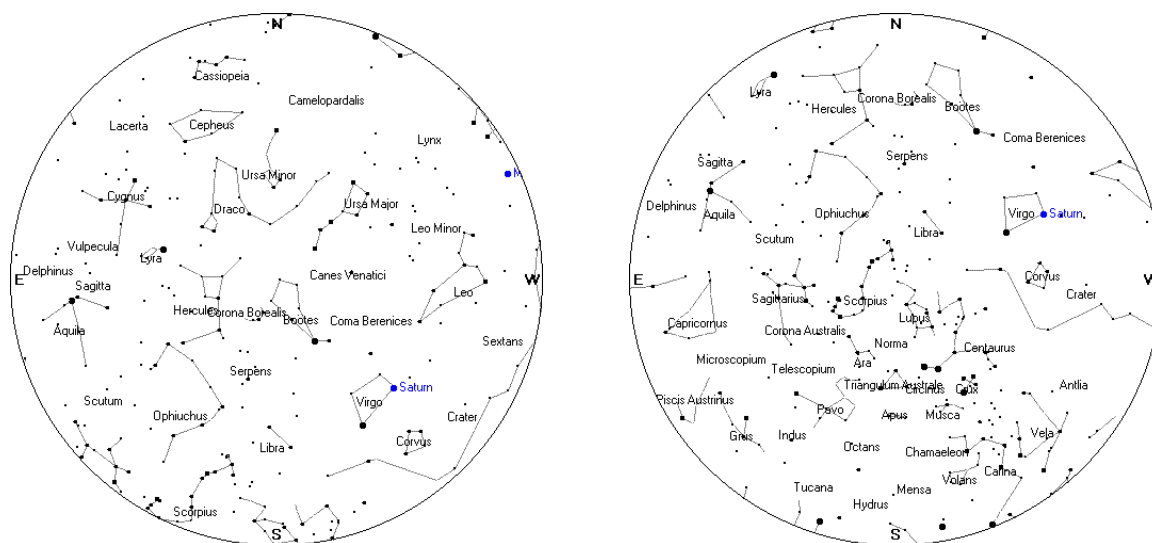

Fig. 1: Example of plane of the sky (SkyChart). This is for a mid-latitude north, at the middle of July at 22 h, Fig. 2: Example of the plane of the sky (SkyChart). This is for a mid-latitude southern, at the middle of July at 22h.

**Red flashlight.** In the darkness, our eyes slowly open to let in more light, which ensures us to "see" at night; this ability is called "night vision". Night vision is related to one of the two types of photo sensitive cells in the retina: the rods. In the retina there are two types of cells: the cones, sensitive to color and that are activated in bright light, and rods, which are only active at low light levels. If suddenly the area where we are looking become illuminated, the pupil is closed immediately and the rods are disabled. If entering the dark again, the pupil will take a short time to open fully again, but the rods will take at least 10 minutes to allow night vision back. The rods are less sensitive to red light, so using a red light fools the eye into acting as if it was much darker. They will retain night vision better. To create a red flashlight we use a normal flashlight and we add a simple filter using a piece of transparent red paper.

**Food.** We have to consider the real time of the activity will be several hours, counting travel, material preparation, observation, collection and the return journey. The activity will be more pleasant if we share some food and drink (hot or cold depending on the seasonal temperature).

**Green laser pointer.** It is useful to point out constellations, stars, etc. Be very careful with this type of pointer. Never point towards the eyes of the participants in the observation or to

anyone, it can damage them. Never point at airplanes. This tool only can be manipulated by adults.

**Clothes.** Even in summer, in the evening, the temperature always goes down, the wind often blows, and we must keep in mind that we need to be there for a few hours and the weather could change. Plan for it to be much cooler than the daytime temperature.

**Binoculars, telescopes, camera** (see below) these materials change depending the observations that we plan.

**If there are clouds.** A cloudy sky can upset the whole plan. However we have provided an alternative plan: telling stories about mythology of constellations or talk about any astronomical topic. If we have Internet, we can enjoy the popular Google-Earth, but watching the sky (Google Sky) or Mars, or any other simulation program of the sky, or can see a video about something astronomical in YouTube.

## Unaided eye

It is essential to know the sky with the naked eye. That means knowing the names of the major constellations and the bright stars, you only need a chart of the sky, and if it is possible, a green laser pointer. They are also very useful applications for the iPhone/iPad or Android that can line up with the constellations and planets help you orient to the rest of the sky, using the phone GPS. The phone is not affected by clouds so can serve as an alternative if the sky is covered.

The stars that you see depend on where we are: near the North Pole would see only 50% of the stars across the sky, those in the northern celestial hemisphere. Near the equator will see all of the sky eventually, but which ones on a single night depends on the time of the year. Near the South Pole, we see only half again, in this case the ones which are in the southern hemisphere.

The constellations and stars that we recommend knowing are:

### NORTHERN HEMISPHERE

Constellations: Ursa Major, Ursa Minor, Cassiopeia are usually circumpolar, so always visible. In summer also see Cygnus, Lyra, Hercules, Bootes, Corona Borealis, Leo, Sagittarius and Scorpio. The ones you see in winter are: Orion, Canis Major, Taurus, Auriga, Andromeda, Pegasus, Gemini, and the cluster, the Pleiades.

Stars: Polaris (near the North Celestial Pole), Sirius, Aldebaran, Betelgeuse, Rigel, Arcturus, Antares, etc..

### SOUTHERN HEMISPHERE

Constellations: Southern Cross, Sagittarius, Scorpio, Leo, Carina, Puppis and Vela (the three constellations formed the ancient constellation of Argo, the ship of the Argonauts). It is also possible to see Orion and Canis Major from this hemisphere.

Star: Antares, Aldebaran, Sirius, Betelgeuse. In the southern hemisphere there is no star that marks the location of the South Celestial Pole.

The constellations that are in the region called the "Zodiac", can be seen from most of the northern and southern hemispheres although they change orientation on the celestial sphere.

It is interesting to follow the changing phases of the moon every day, and its changing position against the background of stars. This last can be done also with the planets, noting its slow movement on other planets near or on the stars. This is especially noticeable in the faster moving like Venus or Mercury, when you see at sunset. These planets also may be visible at sunrise and then you can continue recognizing them in the sky beyond the night of observation.

For a couple of hours after sunset, you can see shooting stars (meteors) at any time, with a frequency of about 5 to 10 per hour. At certain times of the year there are "falling stars", which are many more. For example around January 3 are the Quadrantids, with about 120 per hour, on August 12 Perseids, with 100 / h, on 18 November is the peak of the Leonids, with about 20 / h, and between 12 and 14 December are the Geminids, with 120 / h. The Perseids are not visible from the southern hemisphere.

There are many satellites orbiting the Earth and when they are illuminated by the sun can be seen from Earth, slowly across the sky. As the altitude is usually not much, you just see them just before sunrise or just after sunset, for example, the ISS is very bright and takes about 2-3 minutes to cover the visible sky. The times of these and many other satellites can be predicted over a given geographical location with a week in advance (see [www.heavens-above.com](http://www.heavens-above.com)).

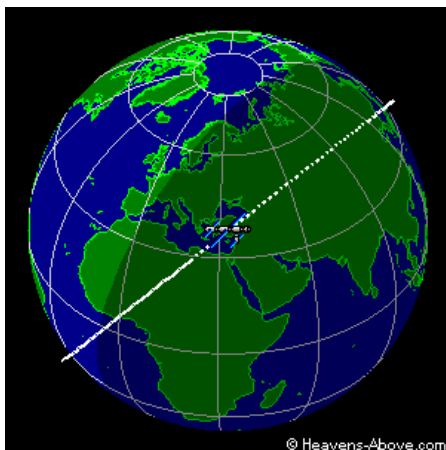

Fig. 3: Path of the ISS



Fig. 4: Expansion and diameter of the objective

## Observations with binoculars

A useful and easily available astronomical instrument is binoculars. Although its ability to magnify is usually small, they collect much more light than our pupil, and help us see objects that at first glance are very faint such as star clusters, nebulae, and double stars. Also

binoculars have the advantage of increasing the color differences of stars, especially if slightly out of focus.

They usually bear inscriptions such as 8x30 or 10x50. The first figure gives the magnification and the second the diameter of the front lens in mm. One highly recommended size for this activity is the 7x50. At higher magnifications, the image moves a lot, because it is difficult to keep steady, and larger apertures increase the price enough.

Interesting objects to see with binoculars are the Andromeda Galaxy (M31), the Hercules Cluster (M13), the double cluster in Perseus, the Praesepe (M44), the Orion Nebula (M42), the entire area of Sagittarius (nebulae such as the Lagoon M8, Trifid M20, Omega M17, several globular clusters M22, M55, etc..) and in general the Milky Way, seen with many more stars than the naked eye. In the southern hemisphere Omega Centauri and 47 Tucanae are spectacular globular clusters.

## Observational telescope

Most people know that the mission of a telescope is to enlarge distant objects, but fewer people know that has another mission as important as this: to capture more light than the human eye. This will allow one to see faint objects that would remain faint even if we increased the magnification.

A telescope has two main parts: the objective and the eyepiece. The objective is a large diameter lens that bends light (refracting telescopes) or a mirror that reflects light (reflecting telescopes). Most objective mirrors are parabolic in shape. The eyepiece is a small lens where, as its name suggests, we place the eye to see. It is usually removable, so that different sizes of eyepiece allow more or less magnification.

The larger the objective is, more light gets collected, and we can see fainter objects. High quality lenses are more expensive than mirrors of the same diameter, so larger telescope are more frequent reflecting telescopes. The most common type is the Newtonian, consisting of a concave mirror at the bottom of the tube, which returns the rays of the top of the tube, where there is a small secondary mirror at an angle of  $45^\circ$ , which deflects the rays to a point outside the tube, where the eyepiece is placed. The secondary mirror blocks some of the incoming light, but is not significant. Another design is the Cassegrain type, which sends the secondary light toward a central hole of the primary mirror. The eyepiece is placed behind that central hole. Finally, there are catadioptrics, typically like a Cassegrai but adding a thin lens at the entrance of the tube, there by greatly reduce the length of the tube and make it more light weight and portable.

**The magnification of a telescope** is given by the ratio of the focal length of objective (either lens or mirror) and focal length of the eyepiece. For example, if we have a telescope with a lens focal length of 1,000 mm and we put an eyepiece of focal length 10 mm, we obtain a magnification of 100. If we want to double the magnification, we will need either a longer

focal length objective or put shorter focal length eyepiece. This has a practical limit because eyepieces with small focal lengths are difficult to manufacture and give blurred images.

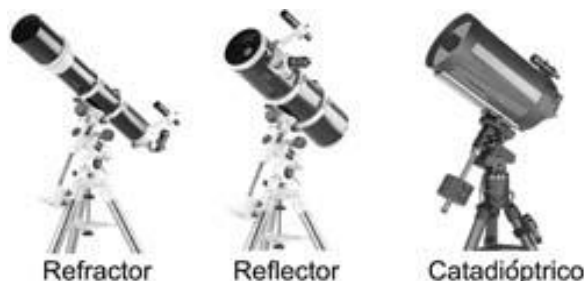

Fig.5: Different optical telescopes

Manufacturers often describe telescopes in terms of focal ratio, for example  $f / 6$  or  $f / 8$ . The focal ratio is the focal length of lens or the primary mirror divided by the aperture and if we know two quantities, can calculate the other. For example, if we have a refractor  $f / 8$  and the objective lens is 60 mm in diameter, the actual focal length of the telescope will be multiplied by aperture, namely  $8 \times 60 = 480$  mm. At the same lens aperture, the larger focal ratio, the smaller field of view and magnification.

The larger the aperture of a telescope will capture more light, and therefore be brighter, and allow you to see fainter objects. Also, it offers a higher level of resolution, which is the ability to see details: when resolution is low you will see a blurred image, and when it is high it looks very clear, with many details. It also influences the darkness of the night: in the days of full moon or light around you can't see faint stars.

Another important limitation is the atmospheric stability. We've all seen how the warm atmosphere of a desert shakes the vision in movie scenes shot with telephoto lenses. When we look through a telescope, small air disturbances make the image move. Astronomers refer to this as the concept of "seeing". The atmosphere is what makes stars twinkle.

The image that you see with a telescope is reversed, but this does not matter much: in the Cosmos up and down positions are relative. There are accessories that flip the image and put it correctly, but at the cost of slightly lower brightness.

The mount is an important piece of a telescope. A poor quality mount allows the telescope tube to swing every time you touch. The result is a dance in the view, apart from feeling dizzy, you will be unable to see the details. It is important that mounts are rigid and stable.

There are two types of mounts: the azimuth and equatorial. The azimuth mount is the simplest but least useful. It can be rotated left and right about its vertical axis, and up and down around a horizontal axis. The Dobsonian mount is a azimuthal type that is easy to transport and use. In the equatorial mount there are two inclined axes situated at 90 degrees to each other. One, the polar, must be directed to rotational pole of the Earth. It turns in right ascension. The other axis, the equatorial axis, gives us the declinations. This is used by professional astronomers and by many amateur astronomers. They may include a motor in the equatorial axis that compensates for the rotation of the Earth. If not, especially with large magnification, the image leaves the field of vision in a surprisingly short time.



Fig. 6: Different mounts support telescopes

If you have an equatorial mount, you should orient it so that the polar axis is aligned with the North Pole (or South) of the sky. That takes time, but is necessary for the equatorial tracking motor, that serves to look at the object, does not move over time, something essential in photography. If we have no motor, exact alignment is less important, but will serve to keep the object in the field of view by moving a single wheel.

Finally, computerized telescopes, with a database of positions of celestial objects and two motors. Once you are set up correctly, these are easier to use. However, you must align it with three known stars in order to set it up, and beginners often are confused by this step.

## The sky's movements

Basically the sky's movements that we observe respond to relative motions of rotation and translation of the Earth. This situation makes that us perceive the sky as a set with two basic movements: daily and yearly.

The diurnal movement is very important, that is very fast and hardly allows us to perceive the annual movement that is much slower. The Earth rotates around  $360^\circ$  in 24 hours; this is  $15^\circ$  every hour. This movement is very noticeable although not we are making not careful observations. The translational motion is  $360^\circ$  every 365 days, which means about one degree every day (just under one degree per day). If we imagine that there were no rotation, we could see in the night sky from one day to the next, the same star at the same time in the same place but run only one degree (i.e. the thickness of a index finger at the extended arm) compared to the previous day. This observation can only be done if we take as a reference one antenna or a post that allows us to relate the observation of a date on the next day. This movement is almost negligible if we do not have a reference and therefore not visible to the naked eye, but what we notice is that the sky of one day of the year is completely different after three months or six months. After three months the translation corresponds to  $90^\circ$ , or about  $1/4$  the sky and in half a year is  $1/2$  sky that is the other side of heaven, diametrically opposed. This movement has been masked night after night because the rotation, but even then we all know that watching naked eye after three months the constellations of the night sky are very different.

## Activity 1: Celestial Dome Umbrella

A simple umbrella can allow us to visualize the movements of the sky explained previously. The umbrella used routinely placed over our heads a dome where we can draw the desired constellations. We will use a black gentleman umbrella and on it will draw with white paint.

In this model we will not draw all the constellations, but only we will draw some constellations and only the more important stars in its. We do not search for beautiful result; we want a working model with which we can think.

Each umbrella will serve to display for one of the two hemispheres. The intersection point between the umbrella's cane and the umbrella's fabric is the pole of the hemisphere considered. The area of the edge of the fabric umbrella (where the ends of the rods are protected with a piece of plastic), tacos rods, corresponds approximately to the celestial Ecuador.

Then, the best is to prepare two umbrellas one for each hemisphere.

In the northern hemisphere will draw:

- In the vicinity of the North Pole (close to the cane of the umbrella) the Big Dipper, Cassiopeia and the polar star which is precisely where the umbrella's cane passes through the fabric
- In the area of the outer edge of the umbrella will draw four constellations, one for each season, the most common and easily recognized:
  - Spring: Leo
  - Summer: Cygnus
  - Autumn: Pegasus
  - Winter: Orion:

Definitely it is possible to choose any other, but must be distributed in an equidistant way, each one located about  $90^\circ$  from the previous one.

In the southern hemisphere represent:

- In the environment of the South Pole (close umbrella's cane) the Southern Cross and the southern celestial pole is located exactly umbrella's cane passes through the fabric
- In the area of the outer edge of the umbrella we will draw four constellations, one for each season, the best known:
  - Spring: Acuaris
  - Summer: Orion
  - Autumn: Leo
  - Winter: Scorpio:

The idea is to choose great constellations and usually above the horizon. This depends a bit of the place of observation, but this proposal can be adapted to each case.

If the city where we are is located is in the equatorial zone between  $20^\circ$  north latitude and  $20^\circ$  south latitude, it is necessary to draw the two umbrellas. If we are located in the northern

hemisphere, at latitude ranges between  $30^\circ$  and  $90^\circ$  we will draw only the umbrella for this hemisphere and the same thing happens if we are in the southern hemisphere.

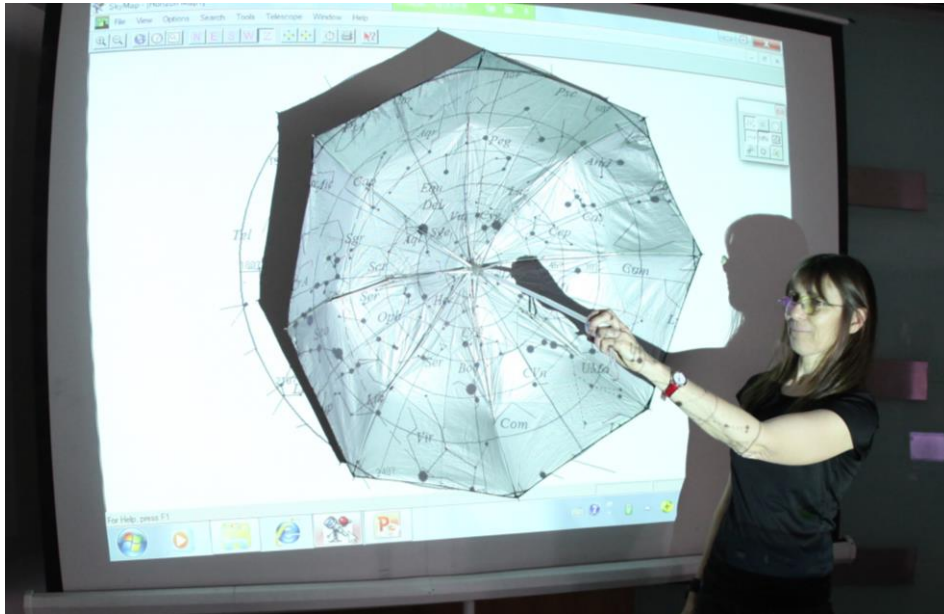

Fig.7: Projecting the stars of the northern hemisphere on a screen to draw the desired constellations. We recommend preparing the model over a black umbrella; although to photography have used one of another color in order to explain the process.

To draw constellations with white paint is very convenient to use Stellarium or a similar software and project the light with a multimedia projector on the umbrella's fabric putting the pole exactly at the point of intersection of the umbrella's cane with the fabric. We will project the corresponding hemisphere (figure 7). Once completed each umbrella we can use it with students placing it above their heads (figure 8).



Fig. 8: Using the northern hemisphere's umbrella with students

We will put the umbrella's cane inclined in the direction of the pole corresponding hemisphere (like the rotation axe of the Earth). Imagine the floor of the room up to our neck,



this would be the horizon, so that part of the fabric of the umbrella would be below this horizon. Then we distinguish two parts in this imaginary horizon. The part that is near the pole where the sky observed throughout the year is always more or less the same (when looking at the area of intersection stick umbrella fabric). The Ecuador's area that remains higher above the horizon is the most interesting part because the constellations change throughout the year (figure 9).

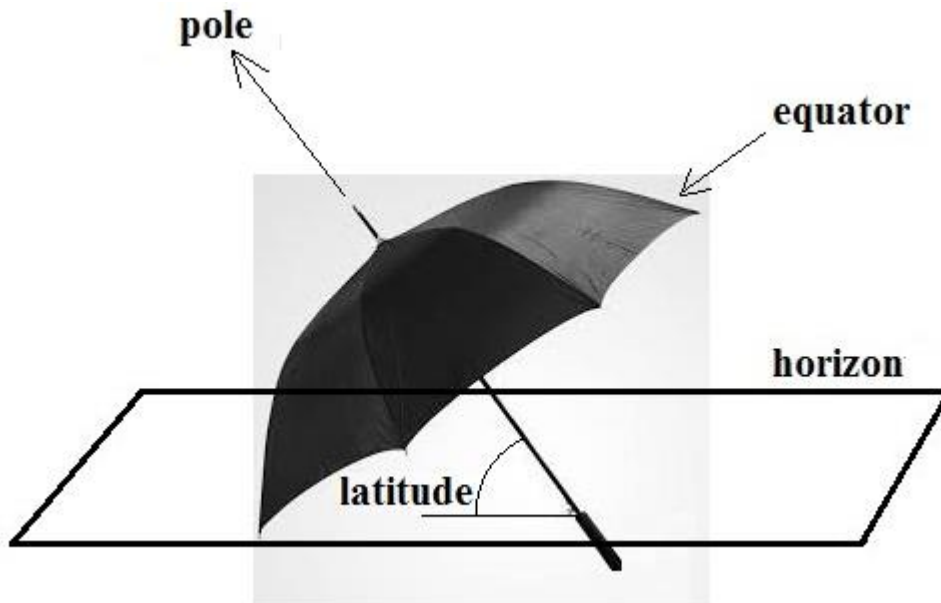

Fig. 9: Umbrella's cane inclined in the direction of the pole according to the latitude. We imagine the plane of the horizon that covers part of the umbrella.

We have to insist that the model explains the translational motion. We imagine that there is no rotation, something equivalent to observe every day more or less at the same time. We also noticed that in this simplified model, we visualize the movement of the sky  $90^\circ$  to  $90^\circ$  discretely, ie every 3 months. As the sky movement is continuous and every day, when it is mentioned that a particular constellation is visible during a season, we must understand that is about the constellation that we see in the center of the horizon in the middle months of the season.

## HOW TO USE

We like to use the umbrella to understand the translational motion.

## Northern Hemisphere

To fix ideas, suppose that we are in a place of latitude  $40^\circ$  North. We put the umbrella of the northern hemisphere with cane North Pole ( $40^\circ$  inclined above ground) above our heads.

In the northern hemisphere the polar star is practically located at the North Pole. It is easy to recognize the constellation of the Ursa Major or Cassiopeia. From the Ursa Major or Big Dipper prolong 4 times the distance between the two farthest stars of the tail of the

constellation and locates the polar star. Using Cassiopeia, the polar is in the intersection of the two bisectors of each V of the double W representing Cassiopeia.

**Northern Horizon**

We look to the polar star area. If we introduce a slight rotation we observe the constellations of Ursa Major and Cassiopeia rotate around the North Pole throughout the year (figure 10).

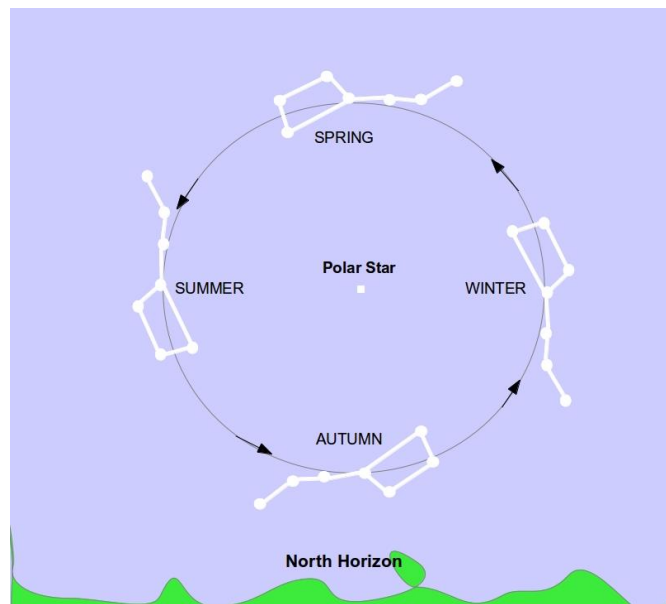

Fig. 10: Relative positions of the Ursa Major around the North Pole throughout the year

We begin by placing the Ursa Major on the top and Cassiopeia down (which happens in spring), we turn the handle of the umbrella 90° in order to have the Ursa Major in the left and Cassiopeia in the right (then we have the situation of summer). Again we rotate the handle 90° in the same direction, then the Ursa Major is down and Cassiopeia is up (this is the position corresponding to autumn) and finally we rotate 90° leaving the Ursa Major on the right and Cassiopeia left (this is in winter). If we rotate again 90° we reproduce the initial situation and begin the four seasons of a new year (figure 10)

As described at the whole process, it is understood that this area of the sky, which is called the northern horizon, this is the area of the horizon corresponding to the North, the constellations that we see throughout the year are always the same and there is more variation

**Southern Horizon**

We consider now the equatorial area, the area of the tips of the rods now. The constellations in this area of the southern horizon vary by season. The central spring constellation is Leo, and then we place the umbrella with Leo in the highest part of the horizon. Then we rotate ¼ turn umbrella, or 90° and we have over the southern horizon, the central constellation of summer: the swan is with Lira and Aquila summer triangle. With another ¼ turn we are in autumn and the central constellation will be the great quadrilateral of Pegasus. And we turn

another 90° we are in winter, and dominates the horizon sky the constellation Orion with his hounds dominates the horizon sky.

### Southern Hemisphere

Consider, for example, latitude of 40° South. We put the umbrella of the southern hemisphere with cane headed south pole (inclined at about 40° from the floor) over our heads.

In the southern hemisphere there is no polar star that allows visualizing the position of the South Pole. The Southern Cross constellation is used to mark the position of the southern celestial pole; this should be extended to the major axis of the cross towards the foot of the cross 4.5 times. This constellation makes one revolution around the pole in 24 hours. The position changes throughout the year for the same time, as shown in figure 10. We assume that is the same time to obviate the rotation of Earth and observe only the sky rotation due to the translation.

### Southern Horizon

Look to the area of the intersection between umbrella's cane and umbrella's fabric, where is the South Pole. We rotate slowly the handle and note that the constellation of the Southern Cross rotates around the South Pole throughout the year. We begin by placing the Southern Cross above (what happens in winter), we rotate the handle of the umbrella 90° until to have the Southern Cross on the right (the position on spring). We rotate again 90° in the same direction, then the Southern Cross is down (this is the position corresponding to the summer) and, finally rotate 90° leaving the Southern Cross on the left of the South pole (as it is in autumn). If we rotate again 90° we reproduce the initial situation and begin the four seasons of a year (figure 11).

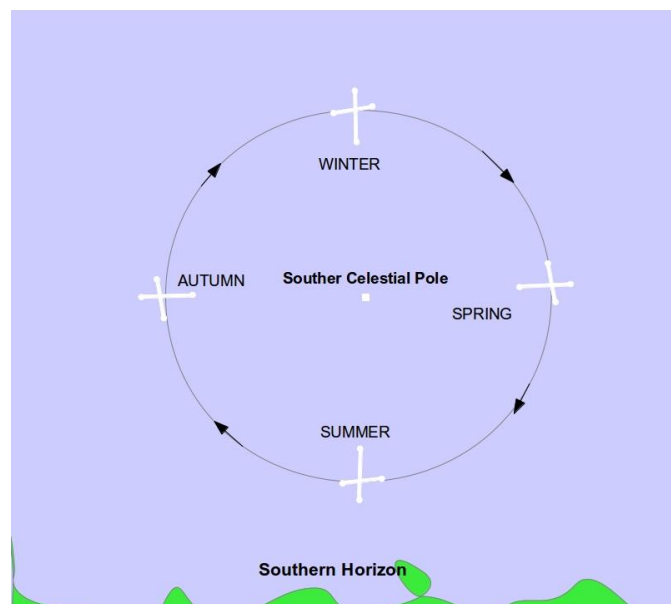

Fig. 11: Relative positions of the Southern Cross around the South Pole during the year

After the described process it is understood that in that area of the sky, called the northern horizon (the area of the horizon corresponding to the North cardinal point), the constellations that we see throughout the year are always the same and there is more variation.

### **Northern Horizon**

We look at the fabric of the umbrella in the equatorial zone, i.e., the northern horizon. This area is where the constellations vary more. Those which are visible in summer, are not visible in winter. Zeus, King of the gods in Greek mythology, put the giant Orion in the sky after his death from the bite of a scorpion. And also, Zeus put this constellation in the sky, but diametrically opposed, so he could not attack Orion again.

The central constellation during spring is Acuaris. We rotate the umbrella  $90^\circ$ , ie after three months and we have Orion with his hounds on the northern horizon which is the central constellation of summer. With another  $\frac{1}{4}$  turn we are in autumn and the central constellation is Leo. If we rotate the umbrella  $90^\circ$  is winter, and we have the beautiful Scorpius constellation on the horizon sky

### **Conclusions for both hemispheres**

Following the scheme presented earlier in both hemispheres for two horizons we can understand the variations in the night sky due to translational motion.

If we want to include the rotation movement in the activity, we have to consider that in addition to the annual motion described a daily movement due to the Earth's rotation makes. In a day both the Ursa Major and the Southern Cross give a complete turn to their respective poles.

To examine just the translation movement is why we have simplified the activity imagining that we always carry out observation at the same time, so it is as the rotation were deleted.

## **Dark skies and light pollution**

To observe the stars, we must have a dark sky. But this is only possible if we turn away from the cities. Humans have forgotten about the starry sky because we can not see it. This problem occurs because most of public lighting produces huge amounts of wasted energy lighting up the sky, which is unnecessary. Light pollution is one form of environmental pollution less known than most others. It affects the visibility of the night sky, but also alters the balance of the ecosystem and affects human health, since it breaches the biological clocks that are coordinated with periods of light and darkness. To be alert on this subject, learn to recognize the problem, warn others of the consequences, and find solutions.

There are three types of light pollution:

- a) The glow is a phenomenon that occurs, in general, by the public lighting outside. It is evident when we have the opportunity to travel at night and approach a city. We see that a light wraps around the city. The light produced by the light glow is wasted, it is

spent on lighting up the sky, which is not needed and, therefore, not only affects our seeing the stars but also spends energy unnecessarily. This type of contamination is reduced by choosing careful light fixtures and bulbs.

- b) The intrusion: the external light is projected in all directions and some of them entered, even unwittingly, to our homes. If the light is projected into the rooms, we will have to block the windows with curtains or shades at night.
- c) The glare: This type of pollution is linked to the lights of cars and even outdoor lighting in cities and homes. It is evident in places with slopes, as the glare occurs when someone finds an unexpected lamp or a reflector. In the past, traffic lights based on LED can also produce this kind of light pollution.

It is possible from various programs on the Internet to compile a series of practical activities for working on this issue, we propose only one that is interactive and easy to perform in any setting.

## Activity 2: Light pollution

The objectives of this workshop are to show the polluting effect of unshielded lighting, recognizing the beneficial effect from the astronomical point of view, the choice of a baffle designed to control light pollution and highlight the possibility of improving the view of the stars, while we illuminate those places where we desire more light.

To carry out this experience obtain one cardboard box of certain dimensions that will allow the student to look inward. To draw the constellation that you select (in this example is that of Orion) and mark the stars as points first; later the holes will be made taking into account the diameter of each, depending on stellar magnitude (figures 12a and 12b). The constellation as drawn on the outside of the box should be the mirror image of the constellation, so that it will be seen as it appears in the sky when you look inside the box.

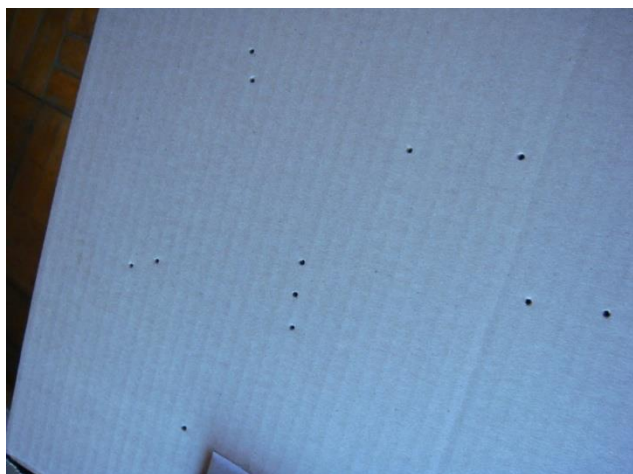

Fig 12a and Fig 12b: Cardboard Box, design of the constellation Orion on one side

The box must be painted black on the inside so that if one looks directly inside , the constellation have the appearance of what is shown in figure 12a and 12b. The "stars", or points that represent them, will be illuminated by the input of the external light inside the box.



Fig. 13: View of Orion from inside the box. Each hole represents a star

Prepare two tennis table balls, making a hole that would allow it to fit over a flashlight. One of the balls is left as it is, and the other is painted with synthetic enamel of any color in the upper hemisphere, representing thus a so-called "shield" that prevents that light from projecting up (figures 14a and 14b).



Fig. 14a: Tennis table ball unshielded, Fig. 14b: Tennis table ball with a hemisphere painted.

To perform the experiment you need to use flashlights in which you can remove the protective top and leave the light bulb as shown in figures 15a and 15b. The tennis table ball is inserted into the flashlight.



Fig. 15a: We removed the protector of the flashlight, Fig. 15b: Flashlight with the tennis table ball simulating the street lamp

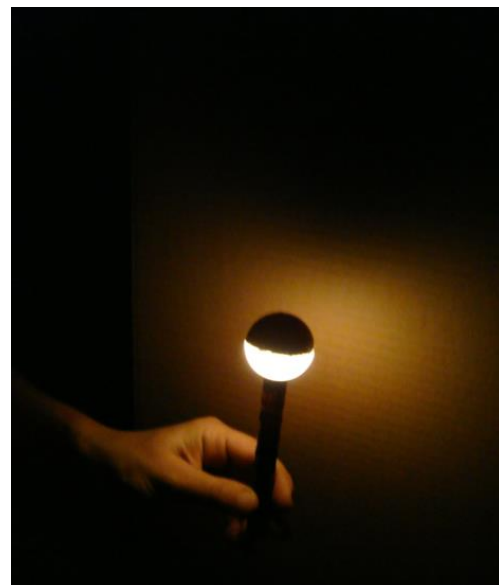

Fig. 16a: Lamp without shielded, Fig. 16b: Shielded Lamp

The experiment was performed in two stages: First with just the box. At this time, turn off the lights during the experiment. Both models are tested with the same flashlight to avoid variations in the intensity of light. Project the light both unshielded (figure 16a) and shielded (figure 16b) projecting the light onto a smooth nearby surface, for example a wall or piece of cardboard.

Second, see what happens inside the box. The situation shown in figures 17a and 17b, for cases with and without shield respectively. You can use a digital camera to take photos of what happens inside the box if it is not possible that participants can look inside. External lights in the room where the experiment takes place should be on.

You will notice what is happening very clearly. In the first situation, in the case of outdoor lighting, we see the situation with the baffle controls light pollution: the emission into the sky is greatly reduced.

In the second situation, when using both types of flashlight inside the box, we are simulating the situation of a night with unshielded lamp that sends extra lighting in the sky, called the glow, which obscures the view of the stars. In the case of digital camera, using automatic exposure, you can not even focus properly at the stars. By contrast, the flashlight adapted to control light pollution, it is clear that this device allows the sky to be much darker and the camera is able to clearly record the constellation of Orion.

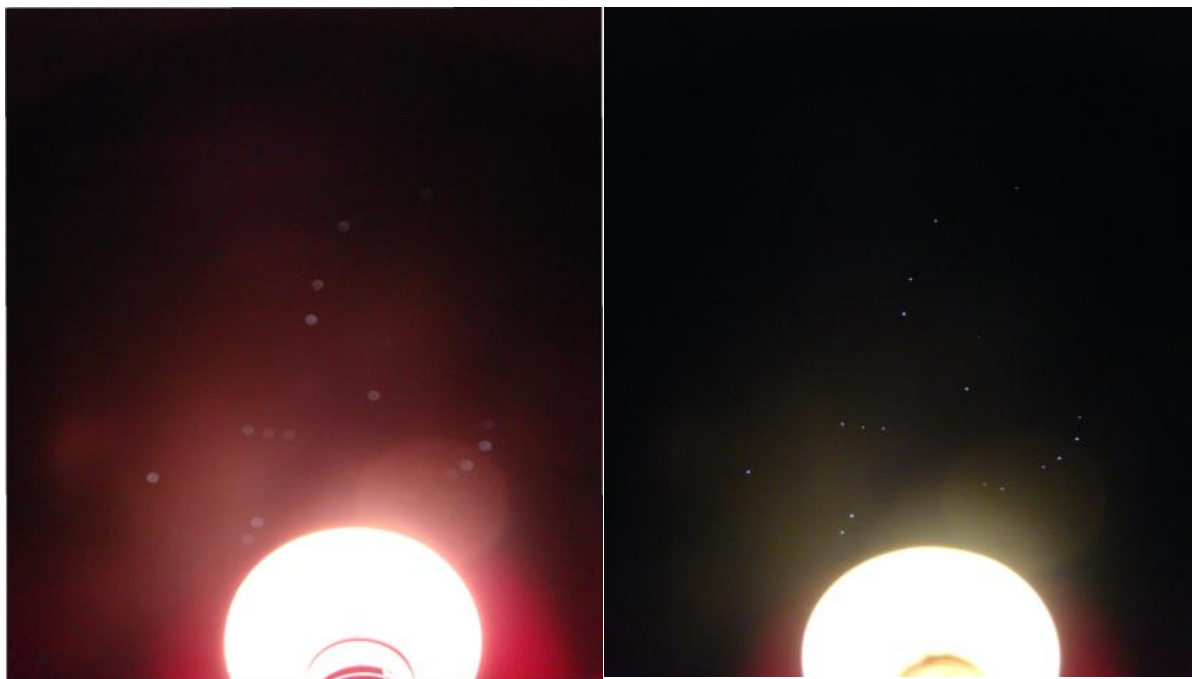



















Fig. 17a: Appearance of the night sky with lanterns without shielded. Fig. 17b: Appearance of the night sky with lights shielded















## Bibliography

- Berthier, D., *Descubrir el cielo*, Larousse, Barcelona, 2007.
- Bourte, P. y Lacroux, J., *Observar el cielo a simple vista o con prismáticos*, Larousse, Barcelona, 2010.
- García, B., *Ladrones de Estrellas*, Ed. Kaicron, Colección Astronomía, BsAs, 2010.
- Reynolds, M., *Observación astronómica con prismáticos*, Ed. Tutor, Madrid 2006.
- Roth, G.D. *Guía de las estrellas y de los Planetas*. Omega. Barcelona 1989.



## APPENDIX: How to Use Stellarium 0.10.6.1

To fix or not the toolbar (to bring the cursor to the lower left corner)	
Location. You can enter by cities, by coordinates or by clicking on a map	
Date and time that is displayed the sky	
Setting the view of the sky. In turn has four menus, which are explained below	
Number of stars, planets ...and to display or not the atmosphere	
Coordinate lines show in the sky, constellations ... Type of projection of the sky. We recommend Stereo graphic or Orthographic	
Show the landscape, soil, fog.	
Names and figures of the constellations and stars in each culture. The best known are the Western.	
Look for an object (i.e. Saturn, M13, NGC 4123, Altair)	
Setting the language and information of the objects shown on screen	
Help (shortcut keys, etc.).	
Normal rate of time	
Speed up time. Can be given several times	
Speed downtime.	
Back to the current time	
Lines of constellations	
Names of constellations	
Figures constellations	

Grid equatorial	
Grid azimuth + horizon	
Ground/Horizon	
Show cardinal Points	
Atmosphere	
Nebulae and names	
Names of the planets	
Equatorial mount / azimuth	
Center on selected object	
Night mode	
Full screen/ window	
Ocular (like looking to the selected object through a telescope)	
Show satellites in orbit	
Getting around the view	←, →, ↑, ↓
ZOOM +	<b>Repág</b>
ZOOM -	<b>Avpág</b>
Define selected planet as the planet from which to see. To return to Earth, look for Earth, and then click Ctrl G (command) to select the planet Earth from which it looks.	<b>CTRL G</b>
Leave / omit trace the path of the planets	<b>May+T</b>
Screen capture	<b>CTRL S</b> ó PrintScreen
Exit(complete with Stellarium)	 ó <b>CTRLQ</b>





na  
se

IAU



INTERNATIONAL  
YEAR OF LIGHT  
2015