

The Young Astronomer's Briefcase

Rosa M. Ros

*International Astronomical Union
Technical University of Catalonia, Spain*



Goals

- Understand the importance of careful observations
- Understand the use of various instruments through the student's construction of the instruments



The Young Astronomer's Briefcase

- All instruments built and organized in a box.

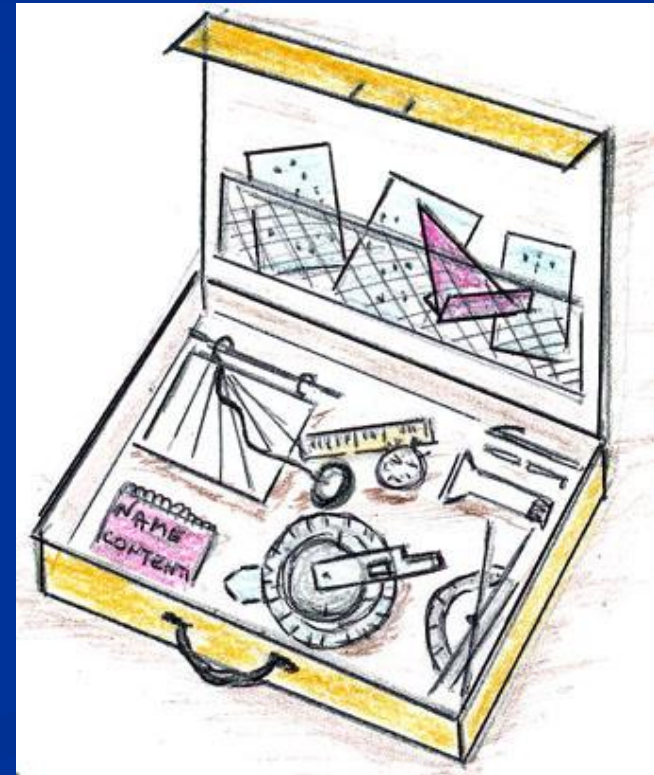

Components of the kit

- “Ruler to measure angles”
- Simplified quadrant
- Simple horizontal goniometer
- Planisphere
- Map of the Moon
- Spectroscope
- Equatorial Sundial
- Red light flashlight
- Compass
- Wristwatch
- Paper, pencil, camera ...



1) “Ruler to measure angles”

- To provide the angular distance between two stars.
- Simple to use if we do not want to use coordinates.

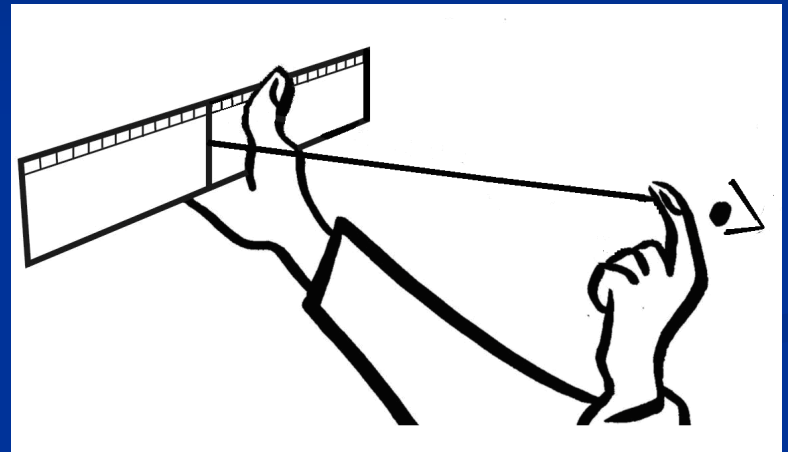

1) “Ruler to measure angles”

- “What is the distance (radius R) needed to obtain a device which is equivalent to 1° to 1 cm ?”

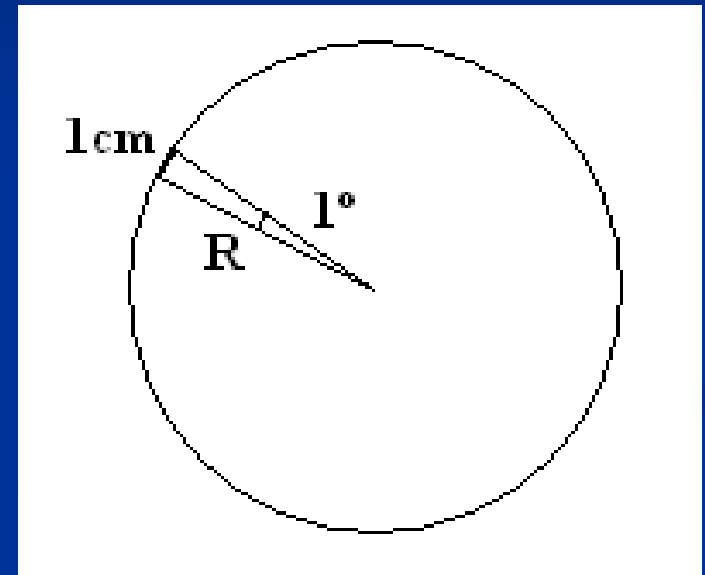

$$\frac{2\pi R \text{ cm}}{360^\circ} = \frac{1 \text{ cm}}{1^\circ}$$

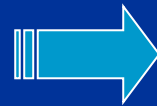

$$R = 180 / \pi = 57 \text{ cm}$$

1) “Ruler to measure angles”

- To build: We set a string of length 57 cm to a non-flexible ruler



1) “Ruler to measure angles”

- We observe with the end of the string almost touching our eye (on the cheek below the eye)
- With string stretched: $1 \text{ cm} = 1^\circ$



Activity 1: To measure the angular distance between two stars or two points



2) Simplified quadrant

- To find the altitude of the stars.
- Work in groups of two students: one looking through the viewfinder and the other making the readings.



2) Simplified quadrant (gun type)

- Rectangular piece of cardboard (approx. 12 x 20 cm).
- Two round hooks on the upper side.

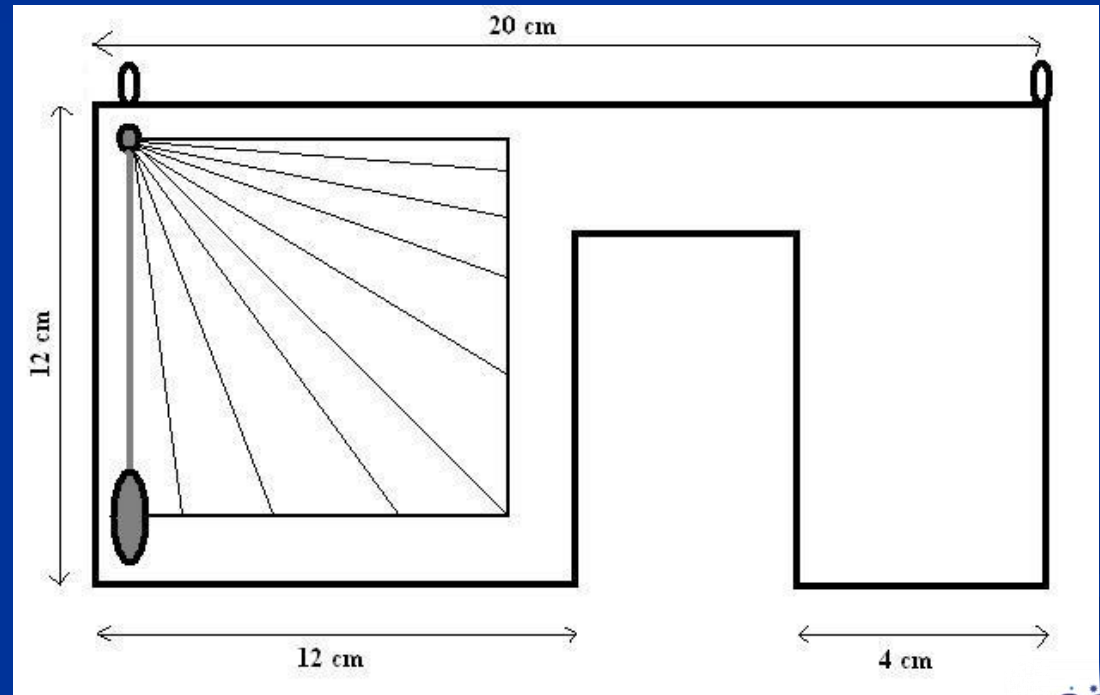
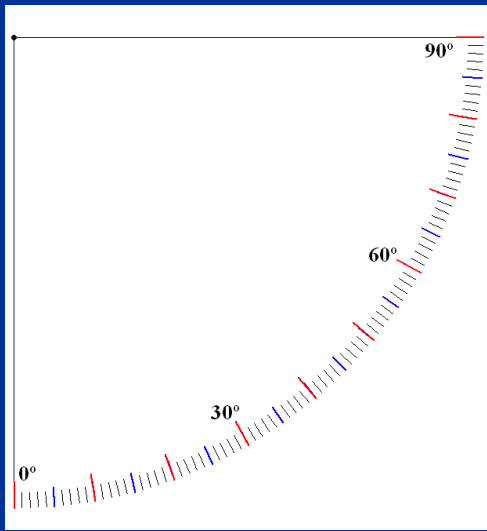

2) Simplified quadrant (gun type)

- If you see the object through the two hooks, the string indicates the altitude above the horizon.

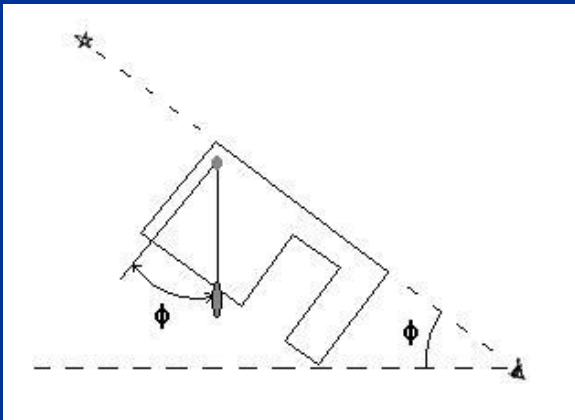

2) Simplified quadrant (gun type)

- A straw with a carton located across the hooks is an excellent viewfinder for measuring the altitude of the Sun by projecting the image onto a piece of white cardboard.

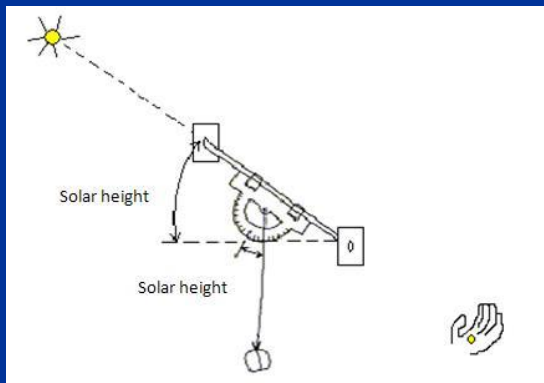

■ **ATTENTION:**

NEVER LOOK DIRECTLY AT THE SUN!

Activity 2: To find the altitude of the Sun, a star or a point in the corridor



3) Simple horizontal goniometer

- To determine the azimuth of the stars.
- You need to use a compass to align the instrument in the North-South direction.



3) Simple horizontal goniometer

- Cardboard 12x20 cm.
- Using 3 "needles" you can set two directions.
- Read the angle between them.

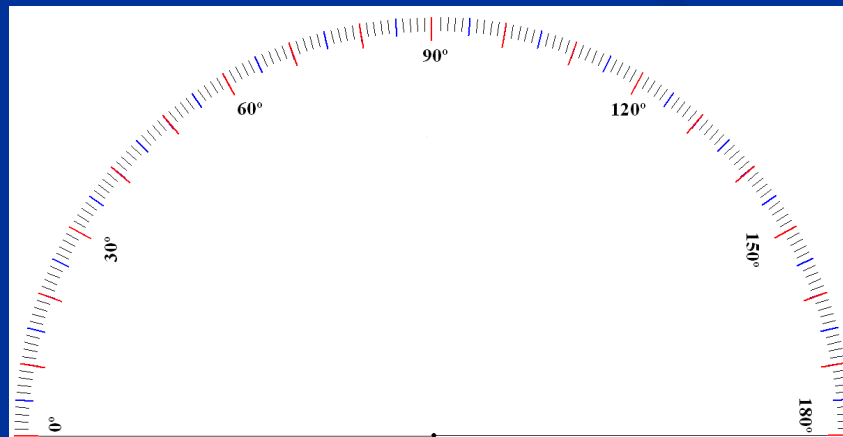
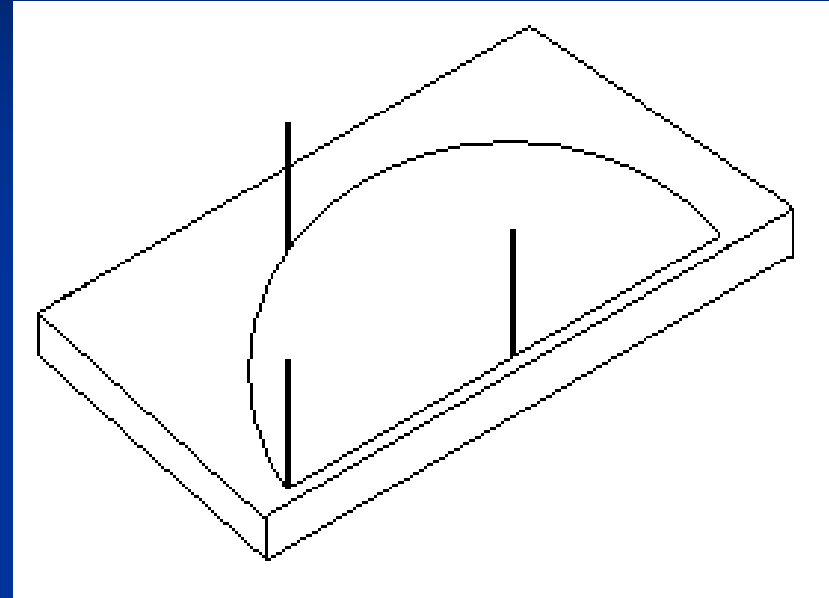

3) Simple horizontal goniometer

- To measure the azimuth of a star, place the origin of the semicircle in the North-South direction.
- Azimuth is the angle from the North-South line through the centre of the circle and the direction of the star.



Activity 3: To determine the azimuth of a star or the angular distance between two stars or two points in the classroom



Horizontal coordinates (LOCAL)

Using the altitude (quadrant) and azimuth (goniometer) of a star we can place it on the local horizon
(depending on the observer)

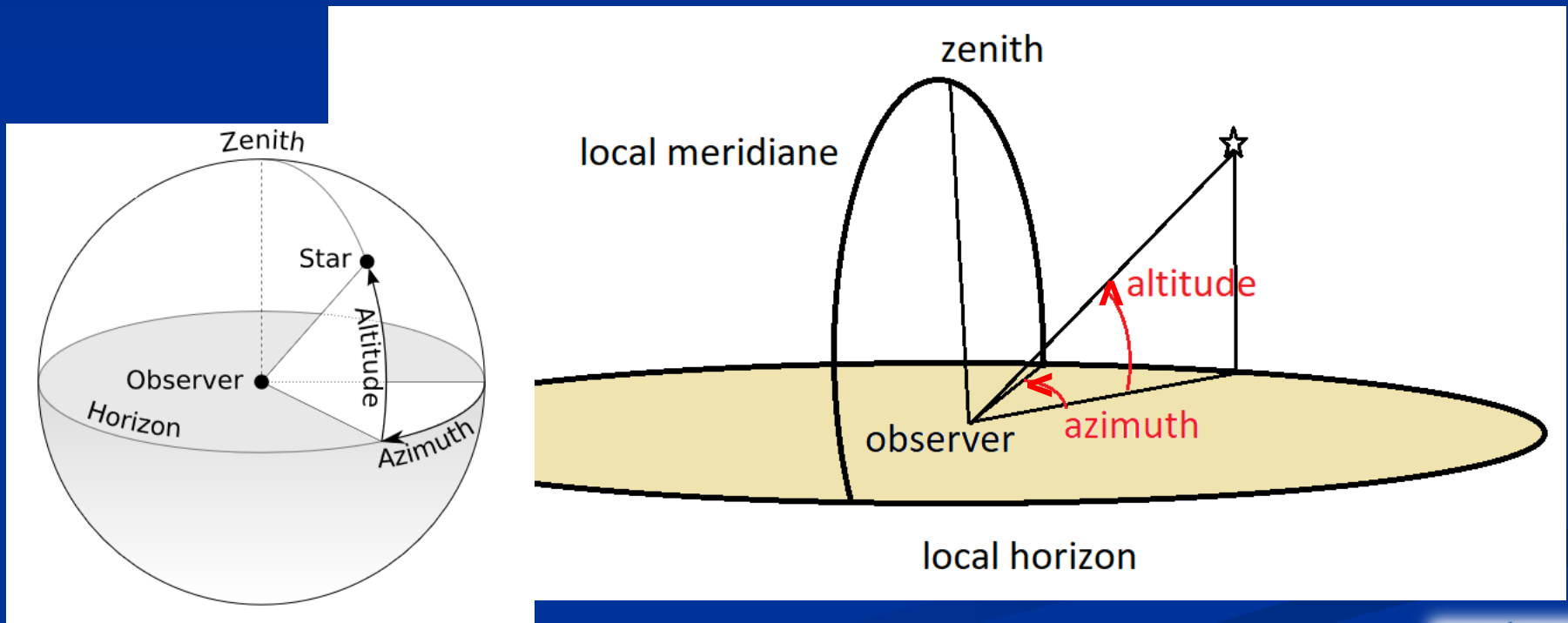

altitude from 0° to 90° from the horizon

azimuth from 0° to 360° from the local meridian (S in Europa, N in USA)



4) Planisphere

- To learn what constellations are visible at your latitude, knowing the date and time of the observation.

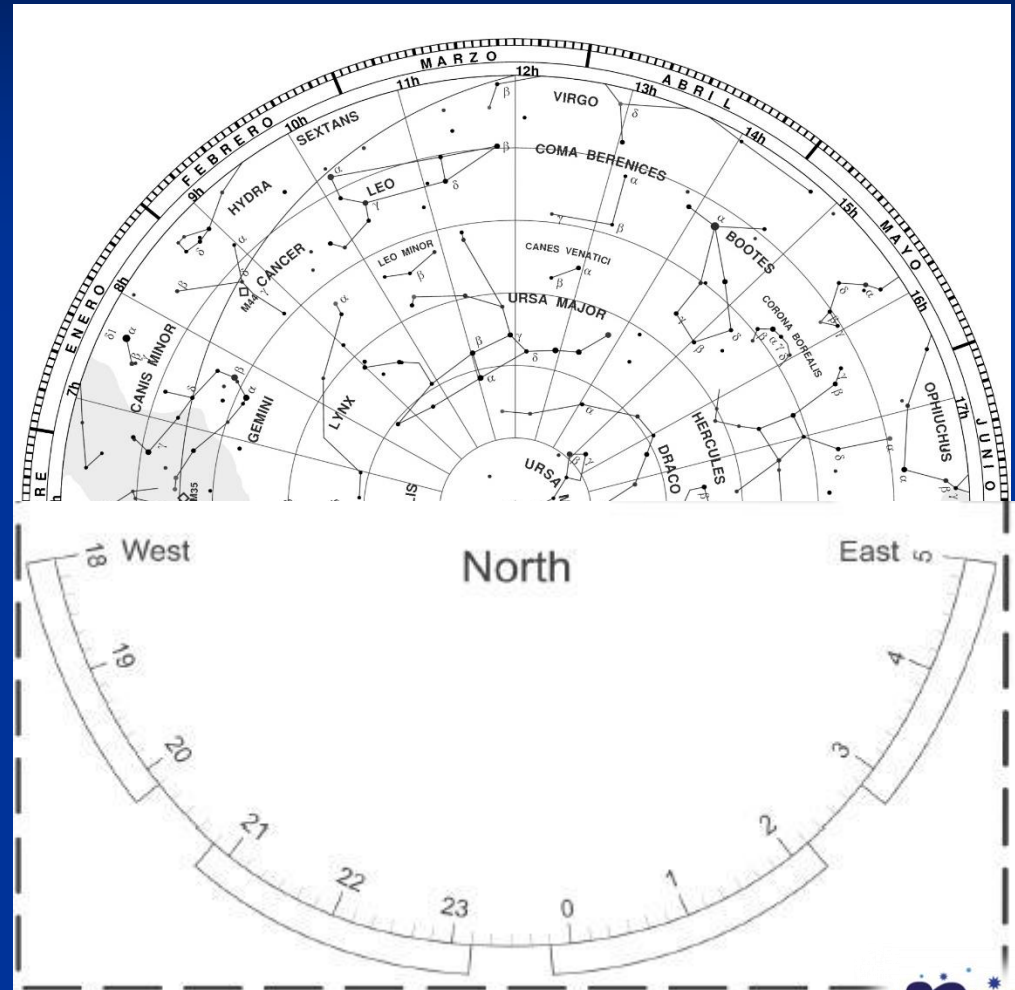

4) Planisphere

- Constellations disc photocopied onto white paper.

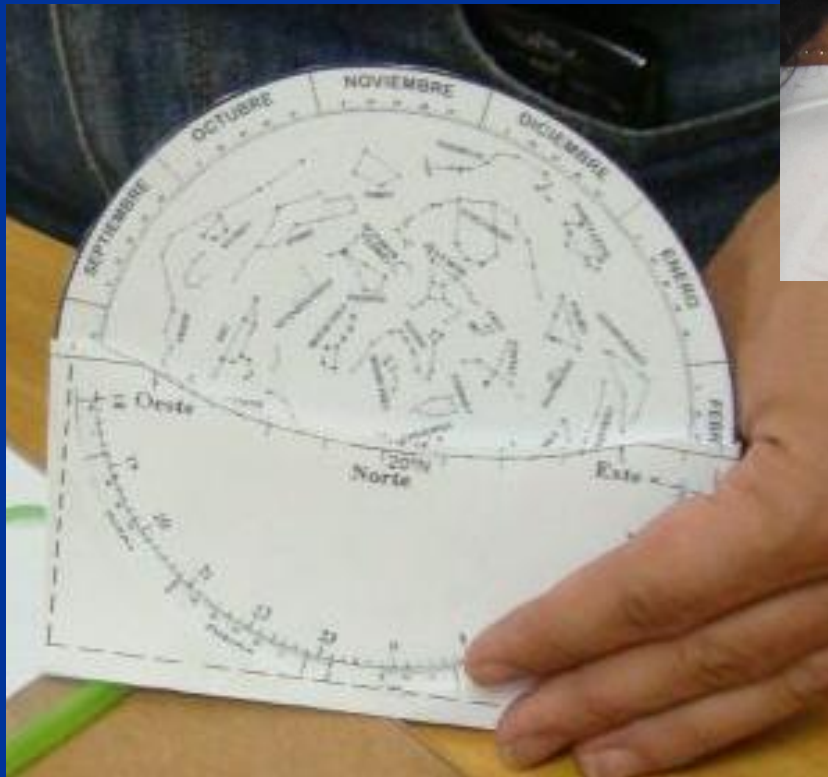

4) Planisphere

- Inside a pocket whose cut-out area depends on the local latitude.

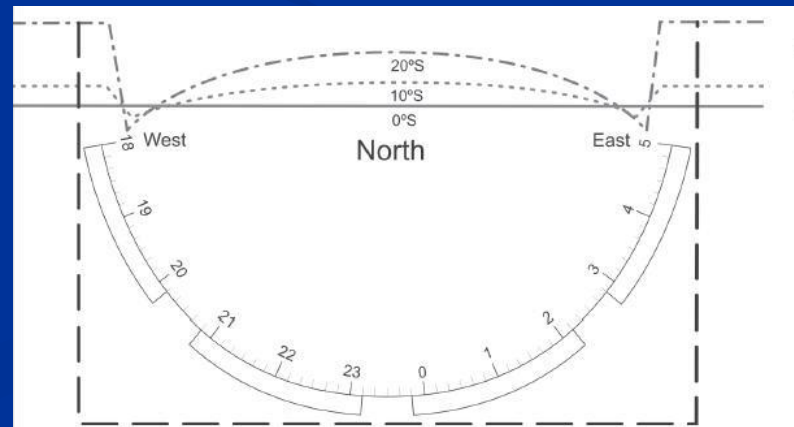
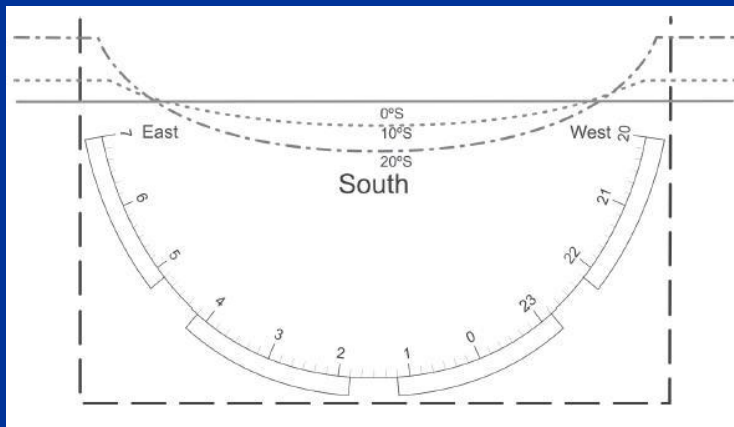
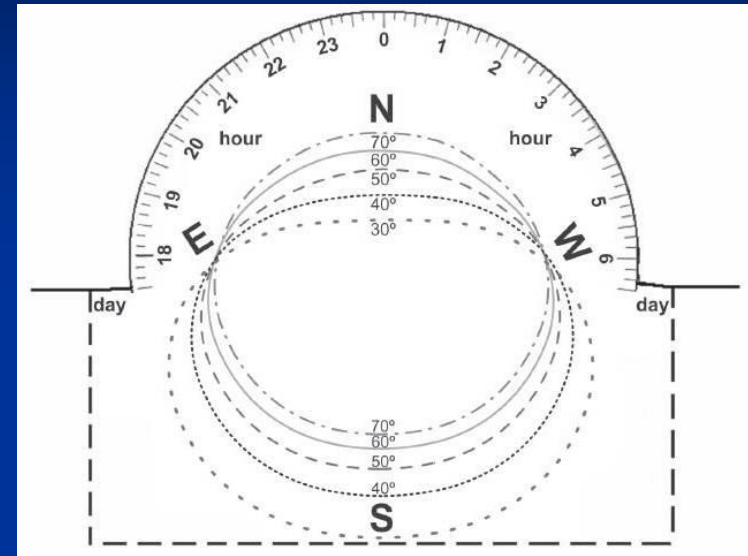

Activity 4: Rotate the disk until it matches the date and time of observation

To use the planisphere in the classroom or in observation sessions



Equatorial coordinates (UNIVERSAL)

Using the declination and the right ascension of a star we can place it anywhere
(it does not depend on the observer)

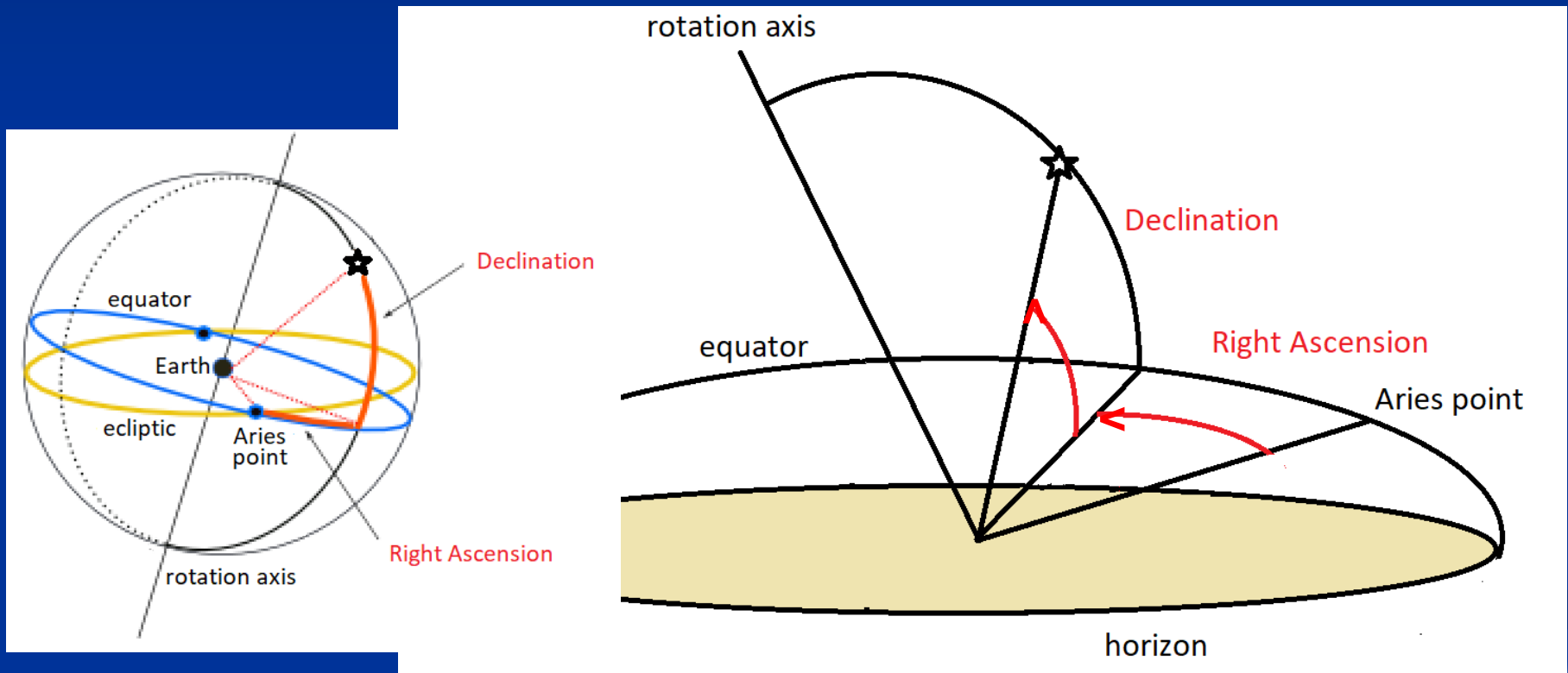

Declination from 0° to 90° N, or from 0° to 90° S

Right Ascension from 0h to 24h from Aries point (ecuador with ecliptic)



Activity 5: Equatorial coordinates

Placing in the planisphere the following candidate stars to host exoplanetary systems

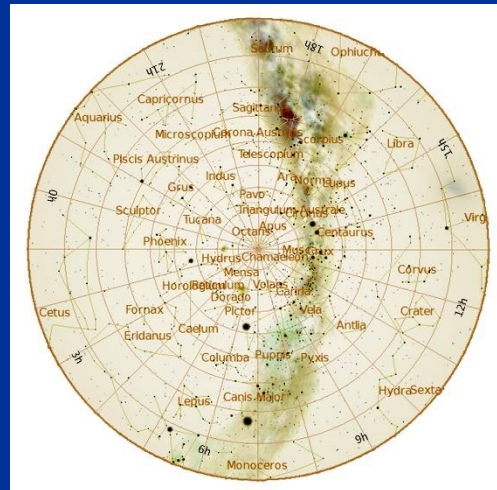
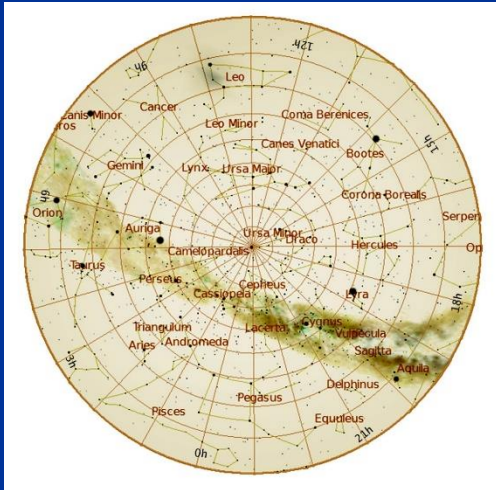

Ups And (Andromeda)

AR 1h 36m 48s

D +41° 24' 20''

581 Gliese (Libra)

AR 15h 19m 26s

D -7° 43' 20''

Kepler 62 (Lyra)

AR 18h 52m 51s

D +45° 20' 59''

Trappist 1 (Aquarius)

AR 23h 6m 29s

D -5° 2' 28''



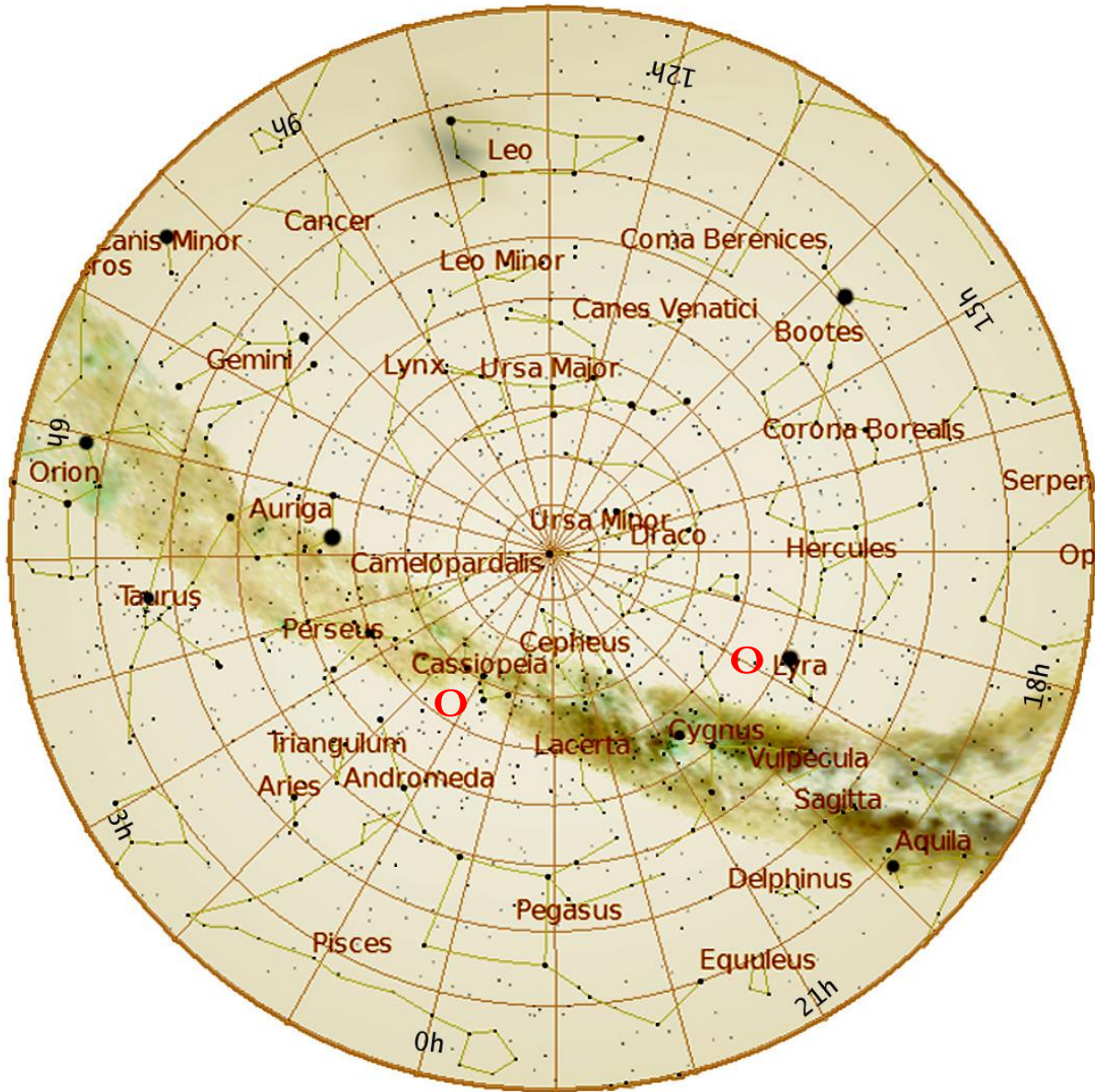

Kepler 62 (Lyra)
AR 18h 52m 51s
D +45° 20' 59''

If we cover it with the latitude window, we can see that the distance to the horizon (altitude) varies with the latitude window

Ups And (Andromeda)
AR 1h 36m 48s
D +41° 24' 20''



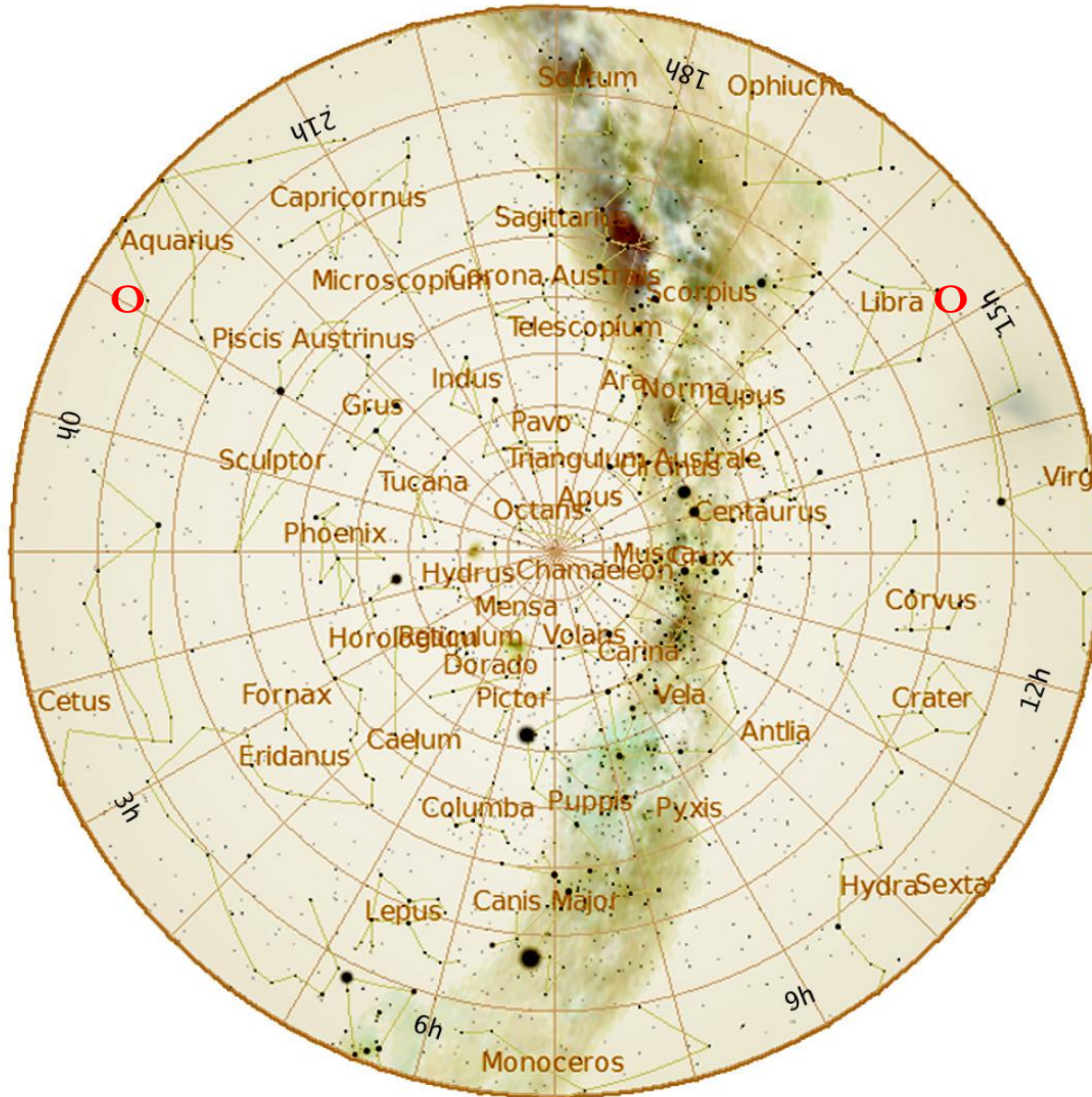

581 Gliese (Libra)

AR 15h 19m 26s

D -7° 43' 20''

Trappist 1 (Aquarius)

AR 23h 6m 29s

D -5° 2' 28''



6) Moon map

- To locate seas (maria), craters and ridges.

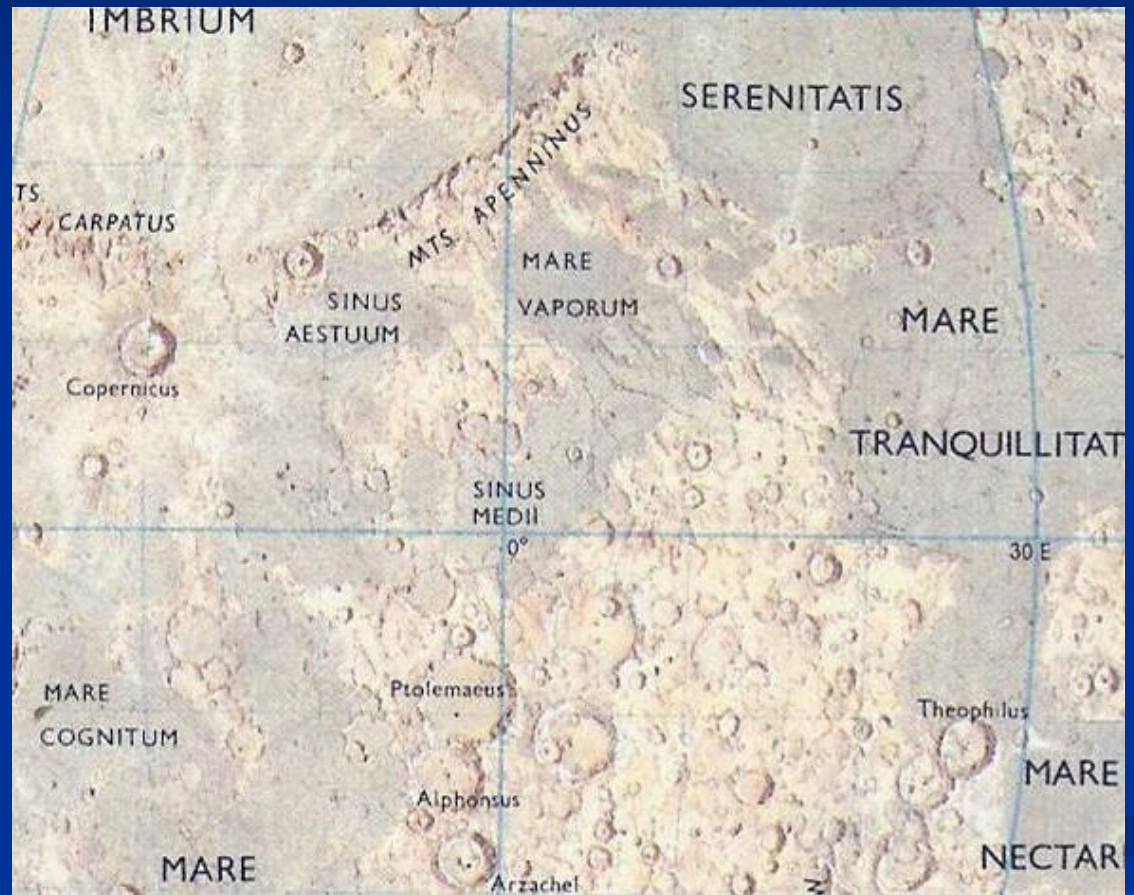

Activity 6: Start by identifying the maria



Activity 6: Continue to identify craters and other features

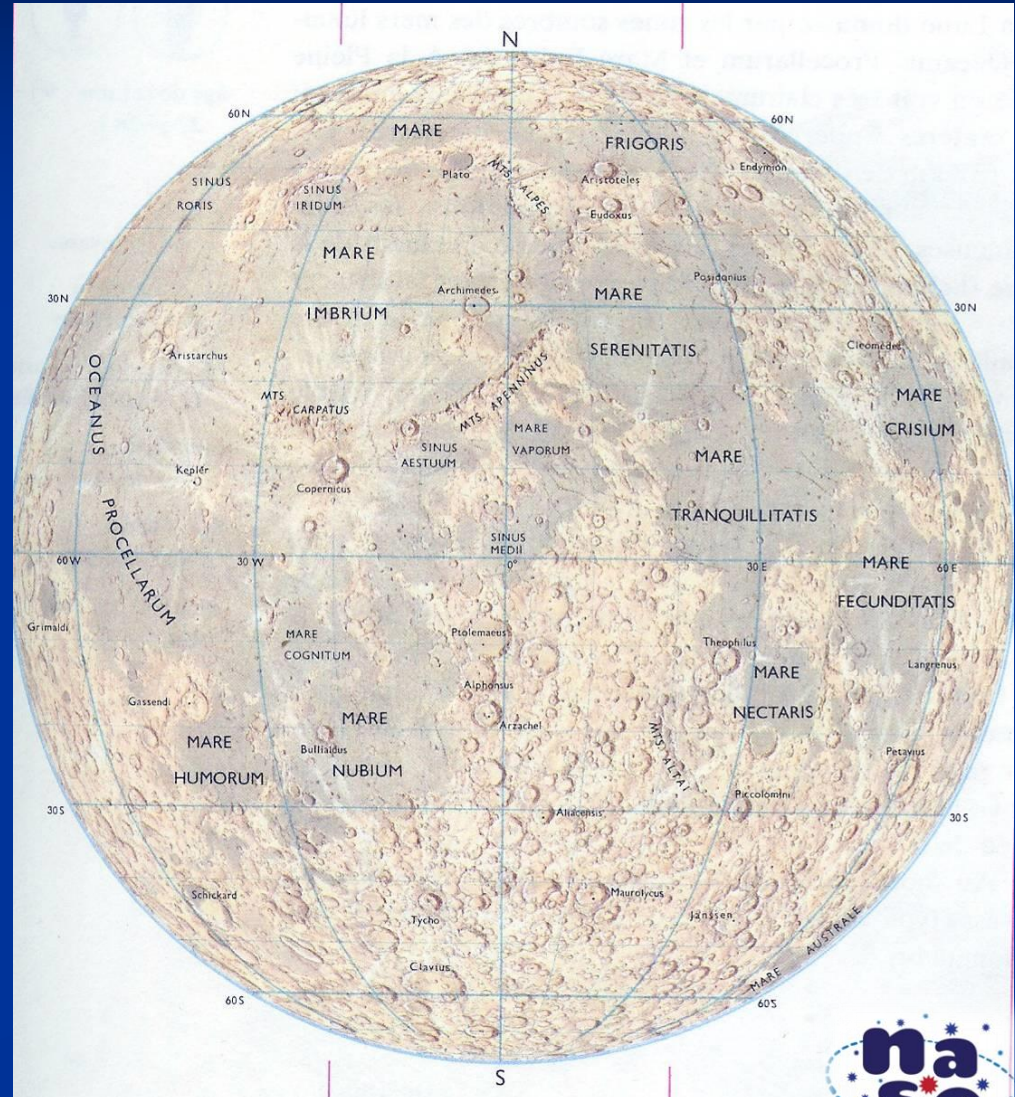

7) Spectroscope

- To display the spectrum of sunlight



7) Spectroscope

- Paint the inside the box black.
- Cut a flap to look at the spectrum within the box.
- Paste a piece of CD on the bottom inside the box (with the recorded area facing up).



Activity 7: Close the box leaving only a slit open in the area opposite the viewer.



- To use the spectroscope with the Sun or the lights of the classroom.
- Photograph of the solar spectrum.



8) Equatorial sundial

- To determine the time.
- You need to use a compass to align the instrument in the North-South direction.
- Workshop Horizon and Sundials.

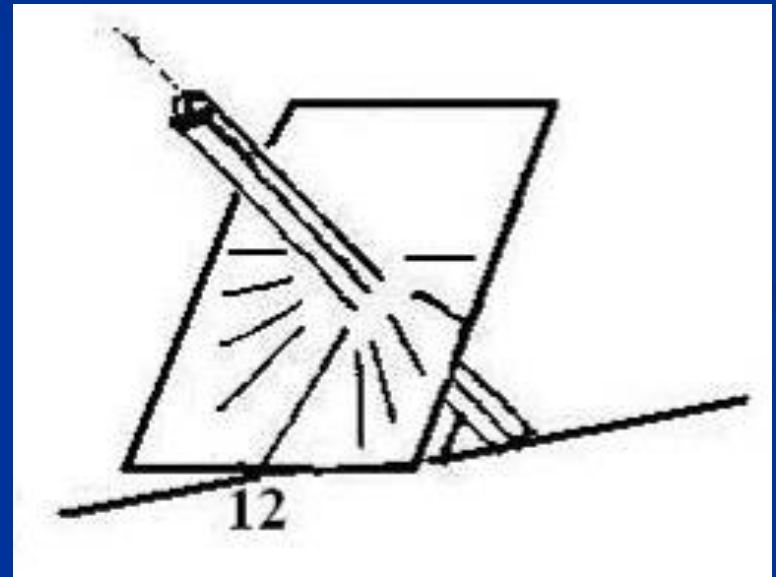

Activity 8: To use the sundial with the corrections

**Solar Time + Total Adjustment
= wristwatch time**

Total Adjustment:

- Longitude Adjustment
- Summer/winter Adjustment
- ET Adjustment



Activity 9: Supplementary material

Preparation of the briefcase

- Compass (to orient instruments)
- Wristwatch
- Notebook
- Pencil or pen
- Photographic camera
- Glasses to see eclipses
- Mobile
- Flashlight (red light)

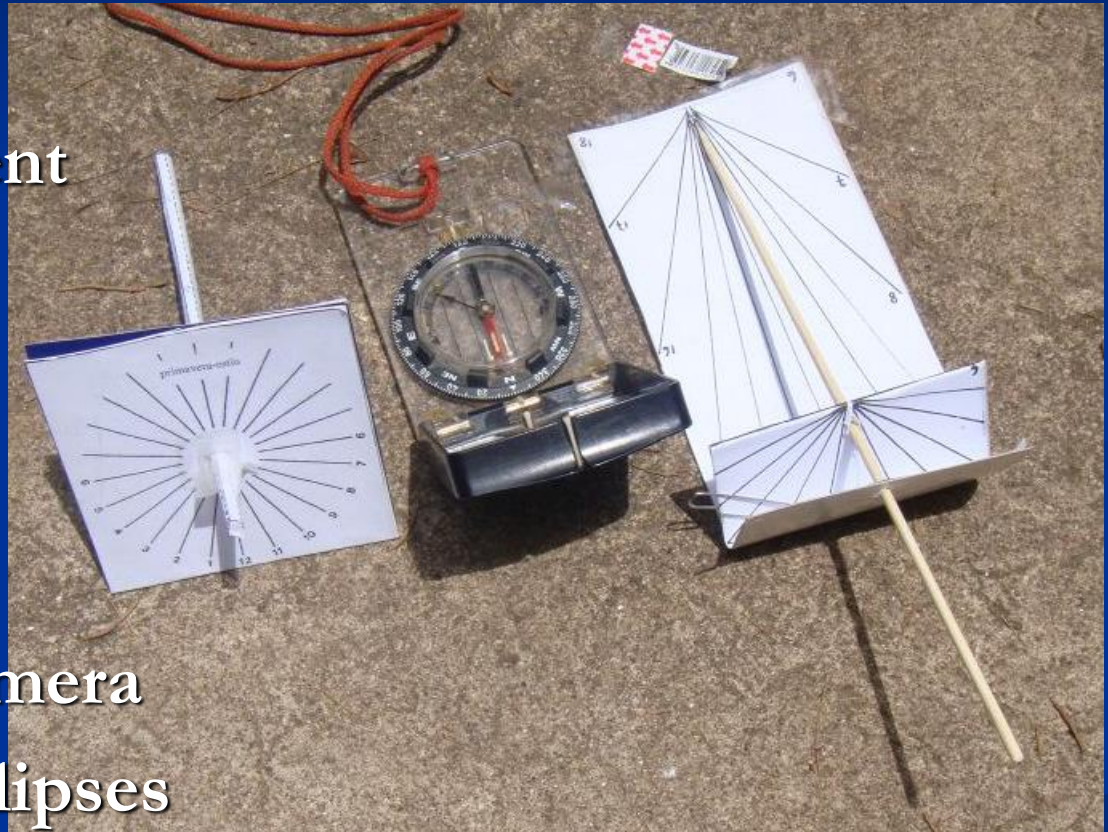

Flashlight (red light)

- Illuminate and study your maps before looking at real night sky.
- Light can disrupt observations.
- You can attach red “cellophane” to your torch (or mobile phone) with adhesive tape.

Prepare the briefcase

- A bag-like folder and a bit of thick rope to make the handle.
- It is enough to make two cuts on the spine of the folder and insert the handle making after a couple of knots.



Conclusions

- Is appropriate that students make their own instruments and use them in their organized briefcase
- With this activity, students:
 - gain confidence in their measurements
 - take responsibility for their own instruments
 - develop their creativity and manual skills
 - understand the importance of systematic data collection
 - facilitate their understanding of more sophisticated instruments
 - recognize the importance of observation with the unaided eye, both in history and today.



**Thank you very much
for your attention!**

